

TERRASYNC™ OPERATION GUIDE

Version 2.40
Revision A
September 2003

CONTENTS

OVERVIEW

- Introduction
- System requirements
- TerraSync documentation

INSTALLATION

- Registering TerraSync
- Installing TerraSync on a CE device
- Installing TerraSync on a PC
- TerraSync Updater utility

TUTORIAL

- Preparing for data collection
- Data collection
- Processing the data
- Preparing for data update
- Data update

ADVANCED FUNCTIONS

- Advanced data collection
- Coordinate systems

REFERENCE

- General operation
- Map section
- Data section
- Navigation section
- Status section
- Setup section

TROUBLESHOOTING

- Communications
- Field computer
- GPS
- Real-time
- Using the TerraSync software
- Position accuracy

GLOSSARY

INDEX

LEGAL INFORMATION

OVERVIEW

This overview provides general information about the TerraSync™ software. The overview is divided into three sections:

- **Introduction** explains how to use the TerraSync software and provides an overview of what you can do with it.
- **System requirements** outlines the specifications required for a computer to run the TerraSync software.
- **TerraSync documentation** lists the documentation available with the TerraSync software.

Introduction

Welcome to the TerraSync software. The TerraSync software is designed for collecting and updating geographical data on a field computer. A field computer is one of the following:

- a Windows[®] CE (a **Handheld PC 2000** or **Pocket PC** running the Windows CE operating system)
- a PC (a desktop computer, laptop computer, or tablet PC running a supported Windows desktop operating system)

You can connect a GPS receiver to a field computer that has the TerraSync software installed and use TerraSync to track GPS status, log data, and update existing data.

This section introduces you to the TerraSync software. The topics covered include:

- **What is the TerraSync software?**
- **What can you do with the TerraSync software?**
- **TerraSync Standard edition software**
- **Using the TerraSync software**

What is the TerraSync software?

The TerraSync software is designed for collecting and updating GIS and spatial data. The TerraSync software acts as the *controlling software*. It communicates with a Trimble GPS receiver connected to the field computer, allowing you to set GPS parameters in the receiver, record GPS positions on the field computer, and update existing GIS data.

The TerraSync software can be used with a wide variety of real-time sources of differential corrections, including an integrated beacon receiver, integrated satellite receiver, integrated WAAS/EGNOS receiver, external radio, VRS™, or Beacon-on-a-Belt (BoB™) receiver.

The TerraSync software provides mission planning in the field and data dictionary creation and editing. The GPS Pathfinder® Office software works with the TerraSync software, providing advanced mission planning and data dictionary creation, as well as data transfer, data import and export, and postprocessing.

What can you do with the TerraSync software?

You can use the TerraSync software to:

- update existing GIS data
- collect data for a GIS or spatial database
- navigate in the field

The TerraSync software is divided into sections.

Use the **Data** section to update data from an existing GIS, CAD, or spatial database. You can review, edit, and update the positions and attributes for features. You can filter data to identify the features required for data maintenance.

You can also use the Data section to accurately and efficiently collect the attributes and GPS position of geographic points, lines, and areas. This information is stored in one or more data files that you can transfer to Trimble's GPS Pathfinder Office software for **postprocessing** and editing, or to the GPS Pathfinder Express service for postprocessing. Data can then be exported into a wide range of GIS-compatible formats.

Use the **Map** section or the **Navigation** section to navigate to specific locations. You can use **real-time differential GPS** to optimize navigation and provide in-field differential accuracy. The TerraSync software is compatible with a range of real-time correction sources.

The Map section shows you all the features in the open data file. A raster or vector map can be displayed in the background for reference.

Use the **Setup** section to control how the TerraSync software interacts with the GPS receiver and with any real-time correction sources, and to configure data collection and display settings.

Use the **Status** section to view summary or detailed information about the software, the GPS receiver, any real-time source you have configured, and the location and health of the satellites the receiver is tracking.

TerraSync Standard edition software

The TerraSync Standard edition is a limited version of the TerraSync software. If you have purchased TerraSync Standard edition, the following restrictions apply:

- You cannot open imported data files. This applies to:
 - SSF files transferred to TerraSync Standard edition using the Trimble Data Transfer utility
 - Data files created from Shapefiles
 - Data files received by e-mail

NOTE — You can use the TerraSync Standard edition to update data files that you have created in TerraSync but not yet transferred from the field computer. However, because of the way in which GPS times are stored, you cannot update GPS positions in files that are more than a week old.





- You cannot display a background image or data file in the Map section.
- External sensors (including laser rangefinders) are not supported.
- RTK data collection using a Trimble[®] 5700 or 5800 receiver is not supported.

You can upgrade the TerraSync Standard edition software to the TerraSync Professional edition, which provides the full TerraSync functionality. To do this, contact your local Trimble dealer.



This manual describes the TerraSync Professional edition software. If a feature or option it describes is not available in the TerraSync Standard edition software, this is indicated with a note at the beginning of the relevant section.

Using the TerraSync software

The TerraSync software is arranged in the following five *sections*:

-  **Map section**
-  **Data section**
-  **Navigation section**
-  **Status section**
-  **Setup section**

One of these sections is always active and visible. The Section list button shows the section that is currently active. You can move between sections at any time without closing any open forms or screens. To switch to a different section, tap the Section list button and then select the section you want from the drop-down list.

For example, to switch from the Map section to the Data section, tap the Section list button and then select  Data. The button now shows  Data, and the Data section is active. When you return to the Map section, the screen or form that was open when you left the Map section appears again.

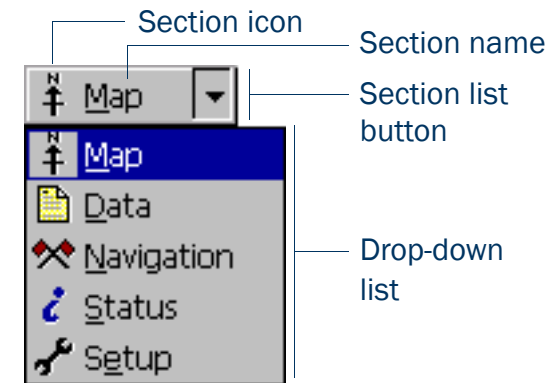

TIP — You can also use **Keyboard shortcuts** to move between sections.

Panes

If you use TerraSync on a field computer that has a screen size of 640 × 240 pixels or larger, the screen is arranged in panes. Each pane displays a section of the software.

Depending on the screen resolution, up to three panes can be displayed. By default, when the TerraSync software opens, the Map, Data, and Status sections are displayed.

To change the size of a pane, drag the resize bar between it and the next pane. Each pane has a minimum size, so if resizing would make a pane smaller than its minimum dimensions, it is automatically hidden. You can use this feature to create three-pane, two-pane, or single-pane layouts.

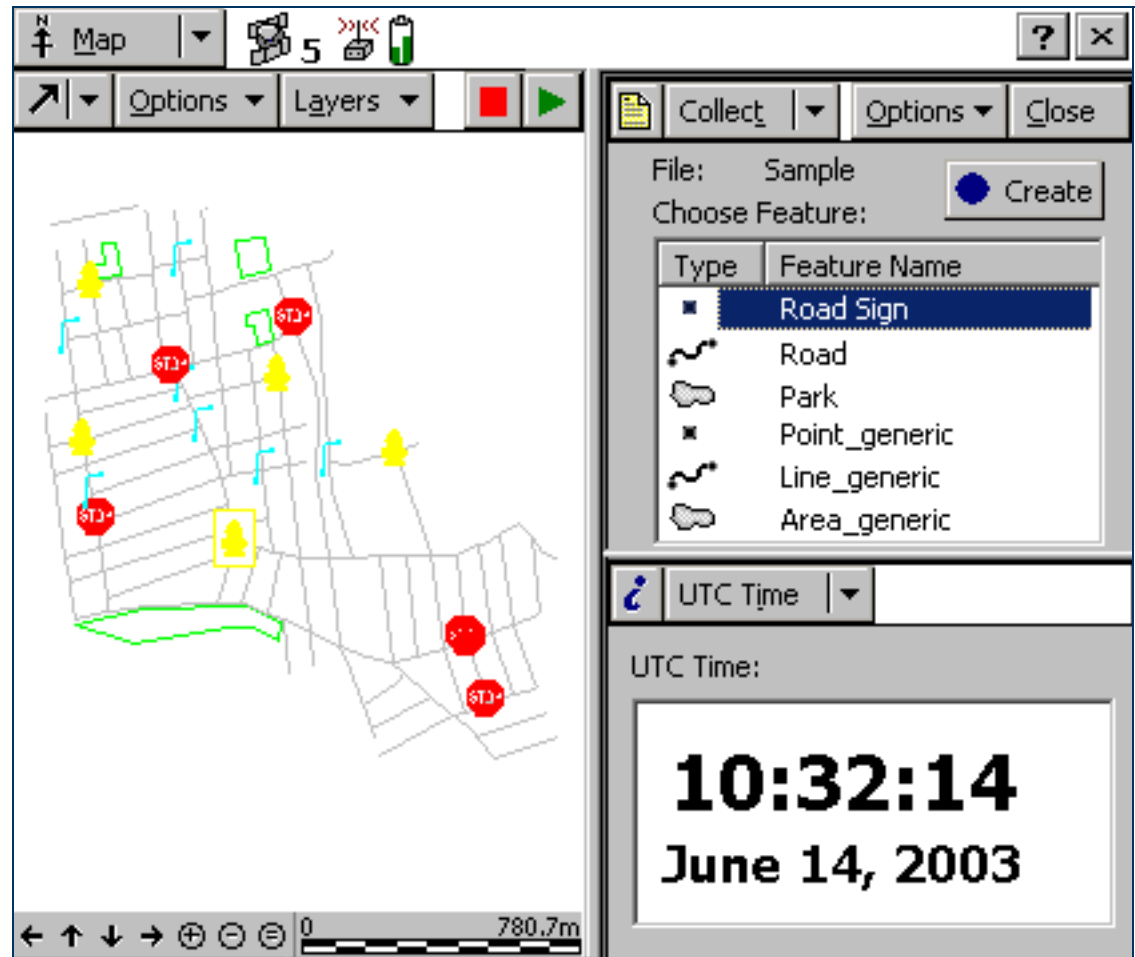

The Section list button determines which section appears in the *primary* pane. The primary pane is the left pane, or the top pane if only two panes are visible.

To change the section that is displayed in the primary pane, tap the Section list button and select a section from the list. If the section is already displayed in another (*secondary*) pane, the two sections swap position.

To change the section that is displayed in a secondary pane, tap the mini Section list button that appears in the top left corner of the pane. Then select a section from the list.

To move a section to a different pane, tap and hold the mini Section button. The icon for the section appears. Drag the icon into the pane where you want the section to be displayed. When you drop the icon, the two sections swap position.

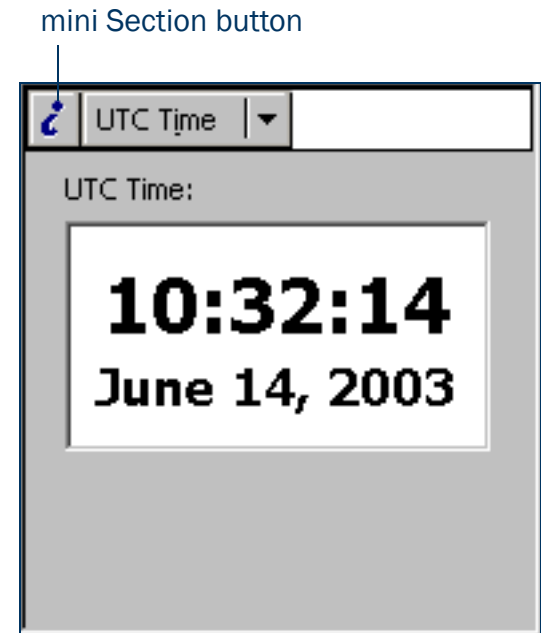

Section structure

Some sections have a number of *subsections*. If the current section has subsections, the Subsection list button is visible. You can switch to a different subsection of the current section at any time. To do this, tap the Subsection list button and select the subsection you want from the drop-down list.

For example, if you are in the Skyplot subsection of the Status section, the Subsection button displays Skyplot. To switch to the Satellite Information subsection, tap the Subsection list button and select Satellite Information.

Some subsections are not always available. For example, in the Data section, you cannot open the Collect Features subsection until you open or create a data file.

Some screens also contain buttons and menu buttons that let you open other screens or forms.

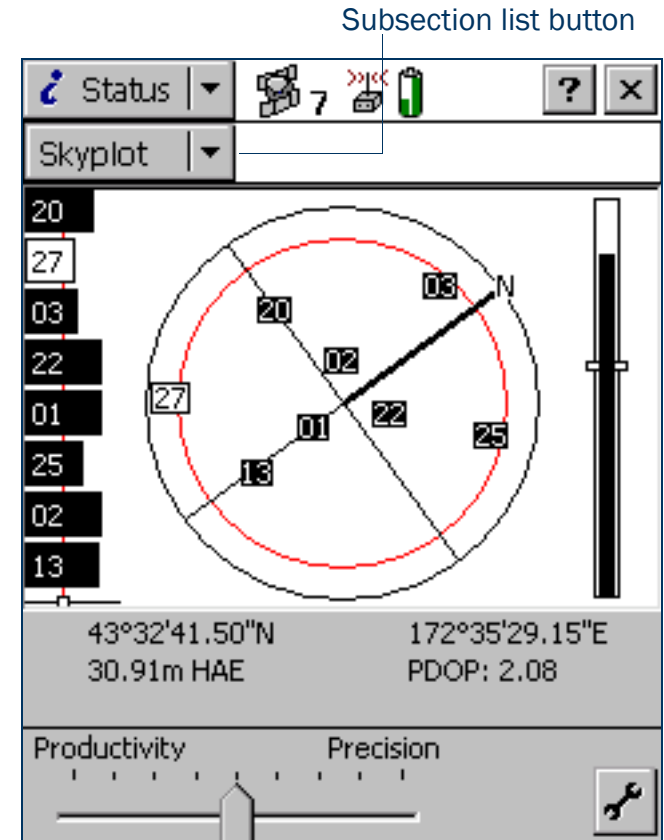

The next five diagrams outline the TerraSync section structure. Use them as a handy reference until you are familiar with the sections and their subsections.

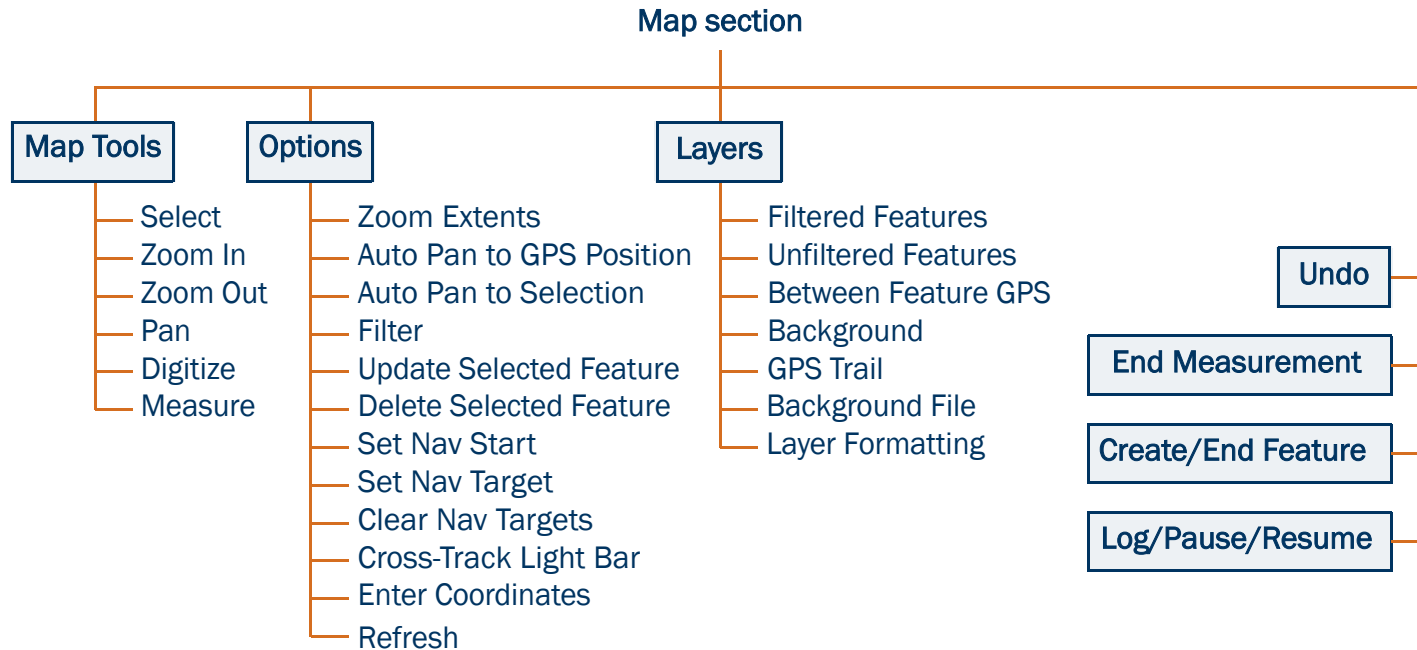

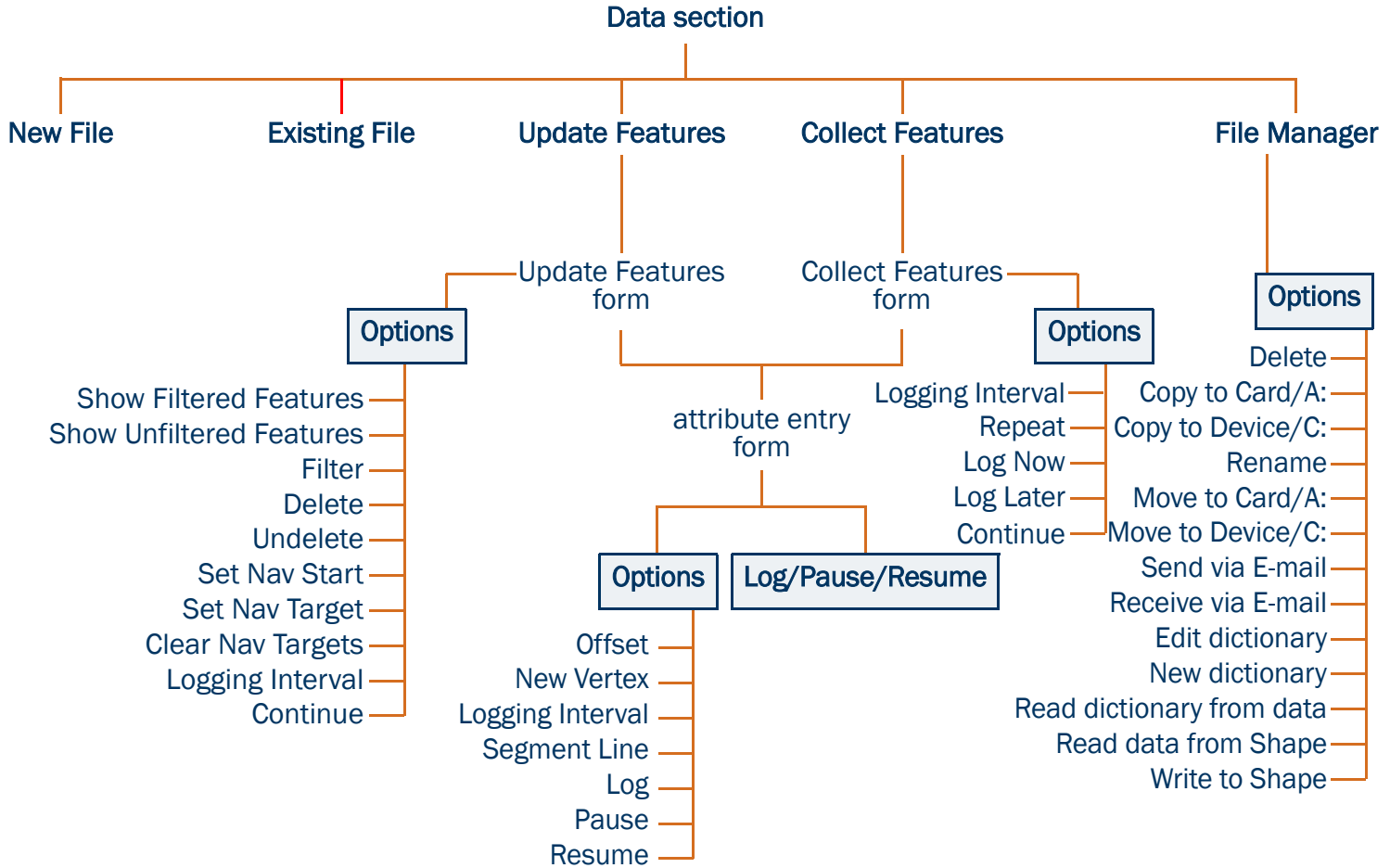

Navigation section

Options

Navigation Options

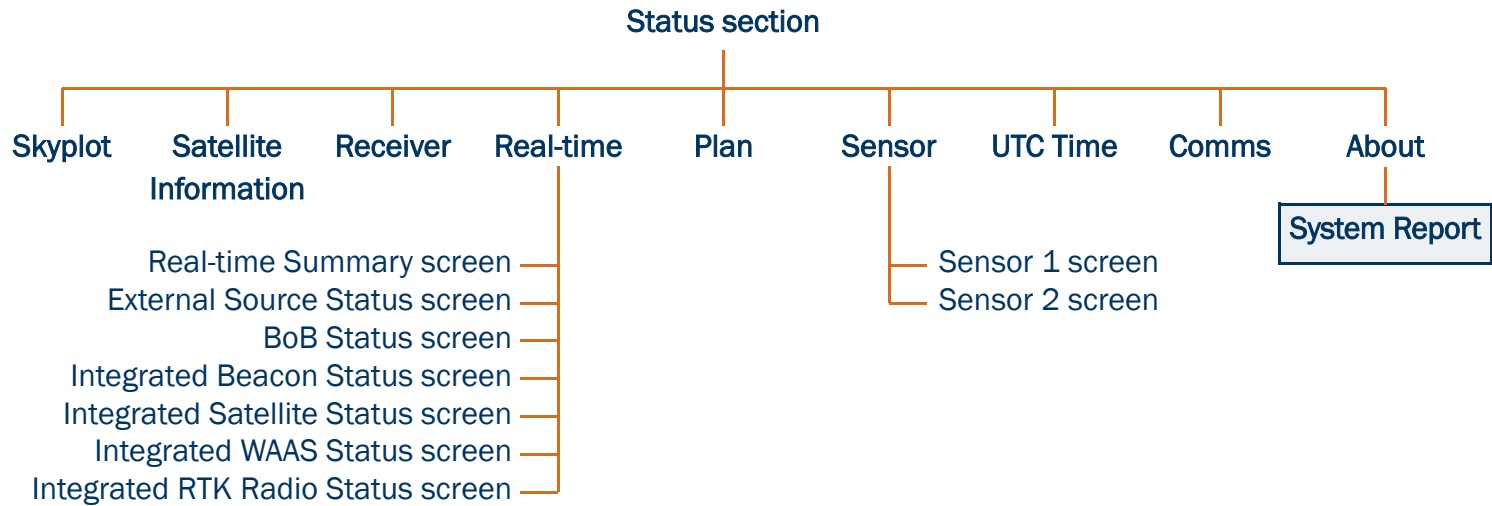

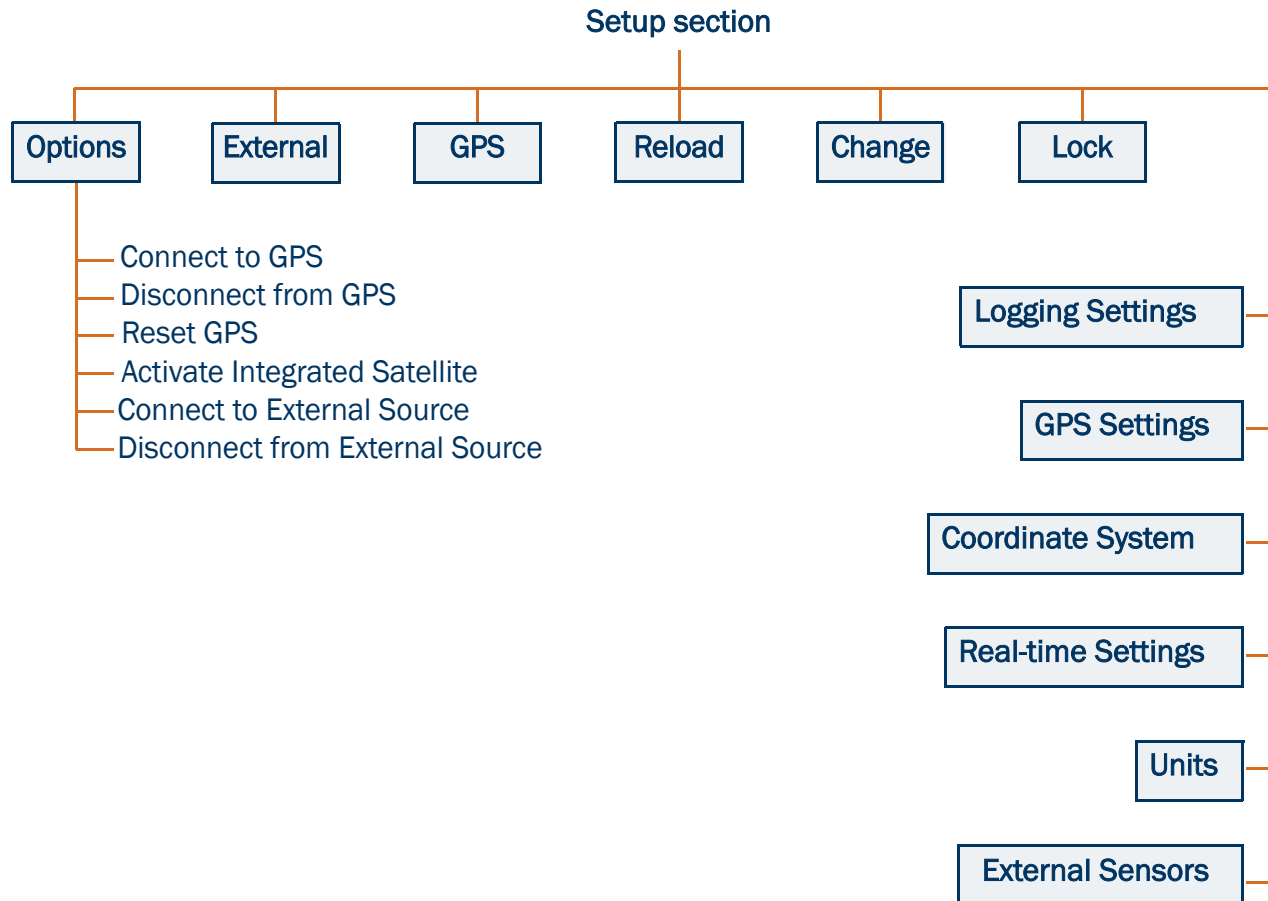

System requirements

This section outlines the hardware and software requirements for the TerraSync software.

- **Field computer specifications**
- **Required software**
- **Supported GPS receivers**

Field computer specifications

The TerraSync software is designed to run on any of the following field computers:

- a **Pocket PC** (P/PC) or **Handheld PC 2000** (H/PC 2000) with a supported Windows CE operating system installed
- a desktop, laptop, or tablet PC with a supported Windows desktop operating system installed

For detailed specifications, including supported operating systems, processors, and memory requirements, refer to the Trimble website at www.trimble.com/terrasync_specs.html.

Required software

To transfer files between a desktop computer and a field computer running TerraSync, you must have one of the following installed on the desktop computer:

- the Trimble Data Transfer utility, which is available for free download from the Trimble website at www.trimble.com/datatransfer.html
- version 3.00 or later of the GPS Pathfinder Office software

Supported GPS receivers

You can connect a computer running the TerraSync software to the following GPS receivers:

- GPS Pathfinder Pro XL
- GPS Pathfinder Pro XR
- GPS Pathfinder Pro XRS
- GPS Pathfinder Pocket
- GPS Pathfinder Power
- GeoExplorer[®] CE series handhelds (combined GPS receivers and CE devices):
 - GeoXM[™]
 - GeoXT[™]
- Trimble 5700
- Trimble 5800

For information on connecting to a receiver, refer to the TerraSync Release Notes.

TerraSync documentation

The following forms of documentation are available:

- [TerraSync Operation Guide](#)
- [Online help](#)

NOTE — The online TerraSync Operation Guide shows the TerraSync software as it appears on a portrait orientation **Handheld PC 2000** with a 240 × 320 pixel screen. On a larger screen, or in landscape orientation, some elements of the software are displayed differently. However, there is no functional difference between the displays.

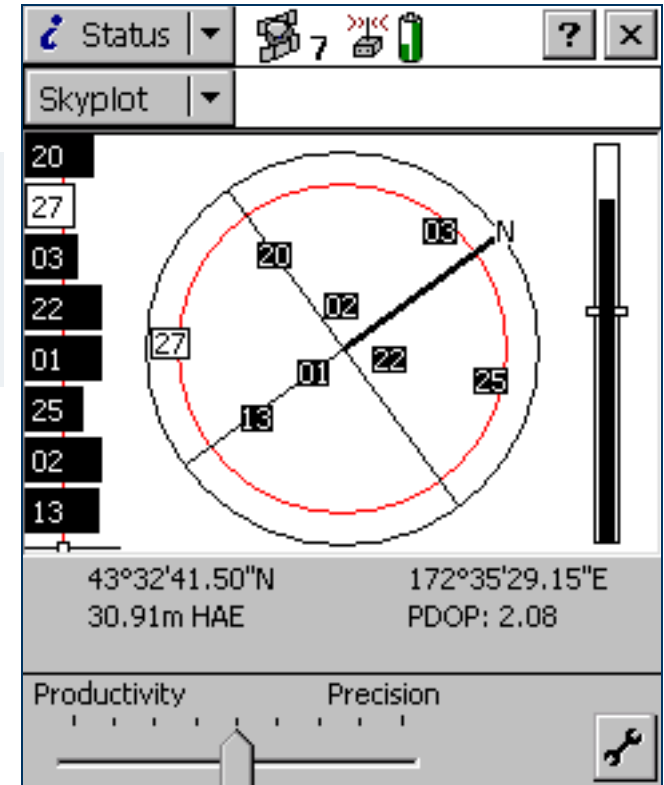

Above: Portrait orientation (240 × 320).
Left: Landscape orientation (320 × 240).

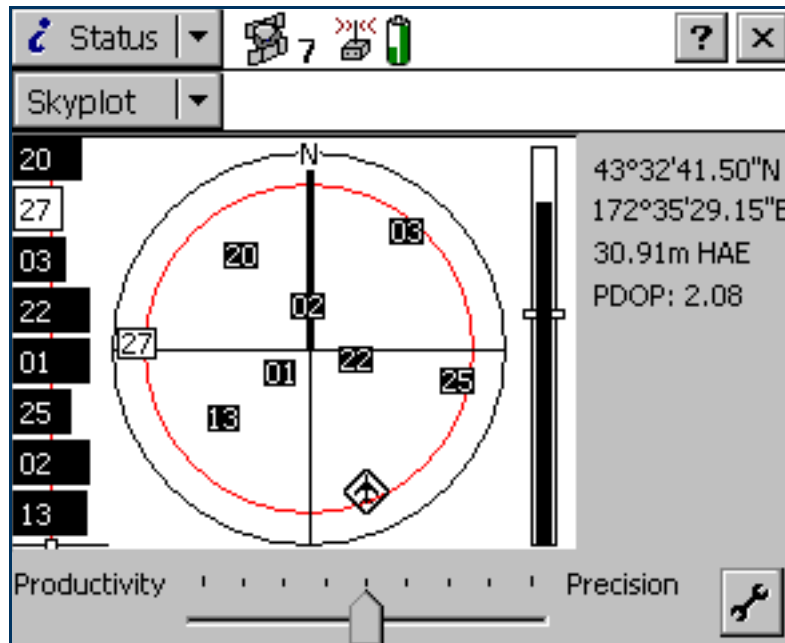

TerraSync Operation Guide

The TerraSync Operation Guide (this document) is the main source of documentation for the TerraSync software. It provides:



- installation instructions
- a tutorial on using the TerraSync software
- a complete reference to all screens and controls
- troubleshooting information
- a glossary of terms

The TerraSync Operation Guide is designed to be opened from the TerraSync CD-ROM and read on the screen.

Online help

You can access online help on the field computer for the TerraSync software. The TerraSync Help is a screen-by-screen reference that tells you what each control on the screen does.

Help is context-sensitive. If you access the Help while the TerraSync software is running, it opens at the topic that corresponds to the current TerraSync screen.

To access context-sensitive help from within the TerraSync software when using a PC or **H/PC 2000**, tap . On a PC, you can also press **(F1)**. To access context-sensitive help when using a **Pocket PC**, tap  and select Help.

If you tap  and select Help on an H/PC 2000, or on a P/PC when the TerraSync software is not running, the main Help Contents topic appears. Select TerraSync to open the Contents topic of the TerraSync Help.

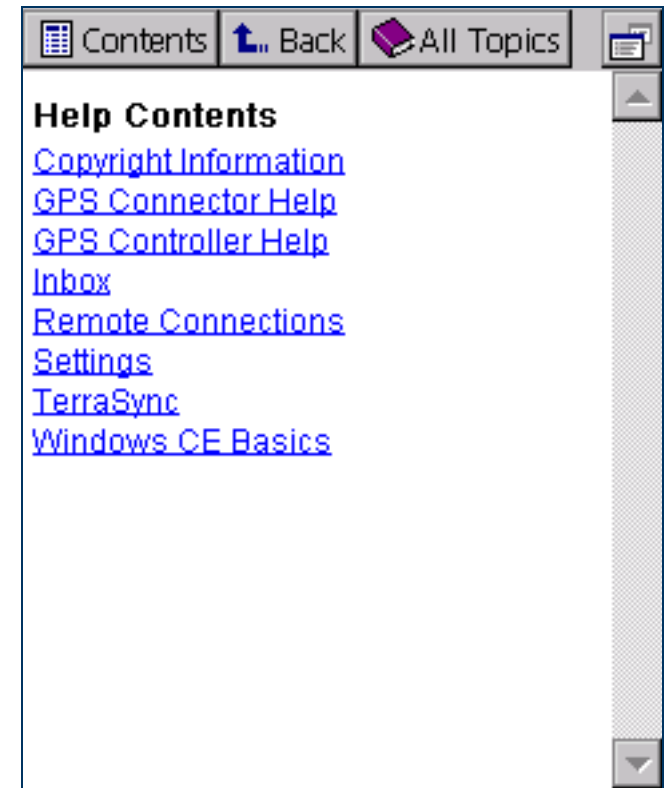

INSTALLATION

To install the TerraSync software on a CE device, use a Microsoft ActiveSync connection. You can install TerraSync directly onto a PC.

To install TerraSync, you need a valid serial number. To obtain a serial number, register your copy of the TerraSync software on the Trimble website. Trimble recommends that you register before beginning installation.

When you install TerraSync, or at any time after installation, you can use the **TerraSync Updater utility** to check the Trimble website for updated software, documentation, and language files.

These installation instructions cover:

- **Registering TerraSync**
- **Installing TerraSync on a CE device**
- **Installing TerraSync on a PC**
- **TerraSync Updater utility**

Registering TerraSync

When you register your copy of the TerraSync software, you receive the serial number that you need to install TerraSync. Trimble recommends that you register before beginning installation. To register, you need:

- the proof-of-purchase number that is attached to the TerraSync packaging
- Internet access (including a valid e-mail address)

NOTE — If you do not have Internet access, contact your local Trimble dealer for assistance.

To register your copy of TerraSync:

1. Insert the TerraSync CD-ROM in the CD drive of the office computer.
2. The Setup screen appears. If this screen does not appear, select msetup.exe from the CD drive folder.
3. Select the Register option. The Registration page opens in the default Web browser.
4. Follow the instructions on the screen to register. You will need to enter the proof-of-purchase number from the TerraSync packaging.

Trimble sends an e-mail to the address that you specified. This e-mail contains the serial number for your copy of TerraSync.

TIP — Keep the e-mail in a safe place. You will need the serial number whenever you install or upgrade TerraSync.

NOTE — If you are entitled to an upgrade from a previous version of TerraSync to version 2.40, you do not have to register your copy of TerraSync. Instead, you can install TerraSync 2.40 using the serial number and authorization key that are attached to the original TerraSync CD case. If the installation program does not accept this serial number and authorization key, contact your local Trimble dealer to obtain a valid proof-of-purchase number.

If you are *not* entitled to an upgrade, the installation program will not accept your serial number and authorization key. Contact your local Trimble dealer to purchase an upgrade option.

Installing TerraSync on a CE device

To install the TerraSync software on a CE device, use a Microsoft ActiveSync connection.

The topics are:

- [Equipment required for installation](#)
- [ActiveSync](#)
- [Installing on a CE device](#)
- [Installing translations on a CE device](#)

Equipment required for installation

To install the TerraSync software, you need the following:

- a CE device as specified in **Field computer specifications**
- a desktop computer with:
 - Windows 95, 98, Me, NT, 2000, or XP installed
 - a CD-ROM drive
 - Microsoft **ActiveSync** installed and an ActiveSync connection established between the desktop computer and the CE device
- a connection between the desktop computer and the CE device (for example, a serial cable, USB cable, or cradle)

For more information on connecting a CE device to a desktop computer, refer to the documentation for the CE device.

ActiveSync

The Microsoft ActiveSync software lets you exchange information between an office computer and a **CE device**. You use ActiveSync whenever you:

- install software on the CE device
- move or copy files to or from the CE device
- **synchronize** data between an office computer and the CE device

NOTE — Before you install the TerraSync software or software upgrade on a CE device, you must first install the latest version of the Microsoft ActiveSync software on the office computer. The ActiveSync software may be supplied on a Microsoft CD-ROM with the CE device, or you can download it from the Microsoft website at www.microsoft.com. For more information on installing the ActiveSync software, refer to the documentation for the CE device.

TIP — To ensure that all installation screens appear in the correct language, install the corresponding translation of the ActiveSync software. You can download translated versions of the ActiveSync software from the Microsoft website

Before you can exchange information you need to establish a connection between the two computers. The first time you connect a CE device to a desktop computer, ActiveSync prompts you to set up a **partnership** or **guest** relationship between the two computers.

Information about a partnership is stored permanently on the desktop computer, while a guest relationship lasts only as long as the two computers are connected. A partnership also lets you synchronize data between the two computers.

NOTE — To transfer data from a desktop computer to the TerraSync software, you can connect using *either* a partnership *or* a guest relationship. Trimble recommends that you use an ActiveSync partnership.

TIP — By default, some CE devices connect to the desktop computer over a serial connection at a **baud rate** of 19200 bits per second (bps). This may make installation and data transfer slow. For the fastest transfer rate, change the CE device connection settings to use the maximum baud rate available. For information on changing the connection speed, refer to the documentation for the CE device.

For information on creating partnerships or guest relationships, and connecting a desktop computer and a CE device, refer to the ActiveSync Help.

Installing on a CE device

Before beginning installation, ensure that you have enough free memory on the CE device. To install the TerraSync software, you require at least 10 MB of free memory. If you are installing to a secondary internal storage location, such as the Disk on a GeoExplorer CE series handheld, TerraSync also requires at least 10 MB of free space in that location, plus 5 MB of RAM.

CAUTION — The installation program cannot determine how much memory is available in the secondary storage location. You must ensure that 10 MB is free before you begin installation.

If there is not enough memory space on the CE device, a message appears during installation, asking if you want to continue. Tap **Cancel**, remove any unwanted programs or data files from the CE device, and/or increase storage memory (see **Changing memory allocation**). Then start the installation again.

If memory space in the secondary internal storage location is insufficient, the installation may appear to have been successful, but error messages may appear when you try to run the TerraSync software. If this happens, make more space available in the secondary storage location, then install the software again.

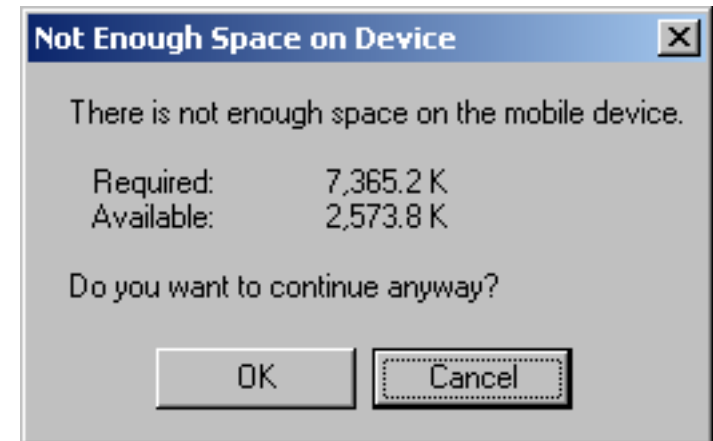

NOTE — If you still cannot install TerraSync on a GIS TSCe™ field device, perform a *full* hard reset, then reinstall TerraSync. For information on performing a full hard reset, visit the Trimble website at www.trimble.com/support.html and click **TerraSync**.

NOTE — Trimble recommends that you uninstall any previous versions of the TerraSync software, and transfer any TerraSync data files to the office computer, before installing the latest version.

To install the TerraSync software:

1. Make sure that you have registered TerraSync and have received a valid serial number by e-mail. For more information, see [Registering TerraSync](#).
2. Connect the CE device to the office computer. For information on connecting the CE device to another computer, refer to the documentation for the CE device.
3. Make sure that the CE device and the computer are switched on.
4. If an ActiveSync **partnership** for these two computers exists, ActiveSync starts and the office computer automatically connects to the CE device.

NOTE — ActiveSync cannot connect to a CE device if the CE device is communicating with a GPS receiver on the same port. If you are upgrading or reinstalling the TerraSync software, make sure that you disconnect from the GPS receiver and exit the software.

If there is no ActiveSync partnership, or if the computers do not connect, you may need to install or set up [ActiveSync](#) on the office computer. For more information, refer to the documentation for the CE device.

TIP — If ActiveSync is installed, but the two computers do not connect, check that the CE device is set up to establish a PC connection. Open the Communications Properties dialog on the CE device. For information on how to do this, refer to the documentation for the CE device. Select the PC Connection tab and check that the Allow connection with desktop computer when device is attached check box is selected.

TIP — Ensure that the CE device is configured to connect at the maximum **baud rate** available. For details on increasing the connection speed, see [ActiveSync](#).

When the two computers are connected, the Microsoft ActiveSync window appears. The message **Connected** is displayed:

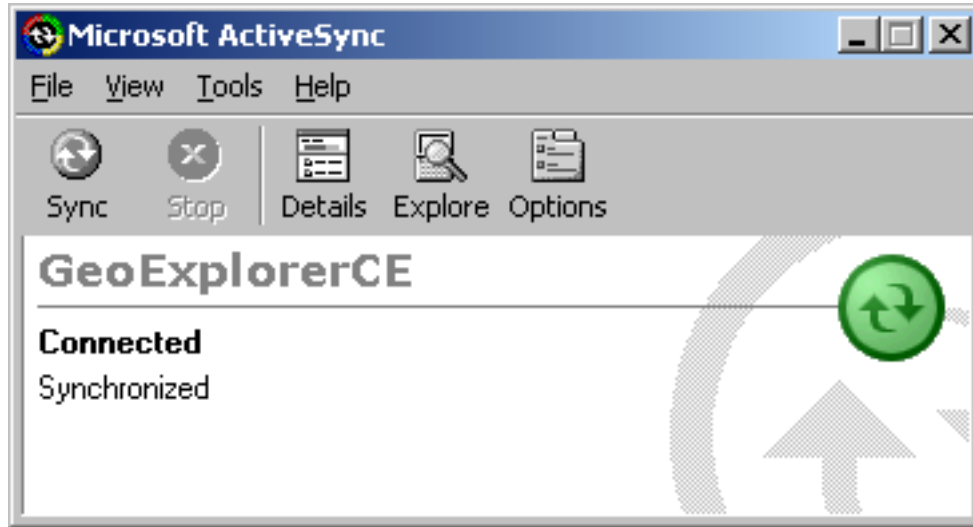

5. Make sure that the TerraSync software is not running on the CE device.
6. Insert the TerraSync CD-ROM in the CD drive of the office computer.
7. The Setup screen appears. If this screen does not appear, select msetup.exe from the CD drive folder.
8. Select the Install option.
9. Select the Install to a Windows CE device option.

The TerraSync installation wizard appears:

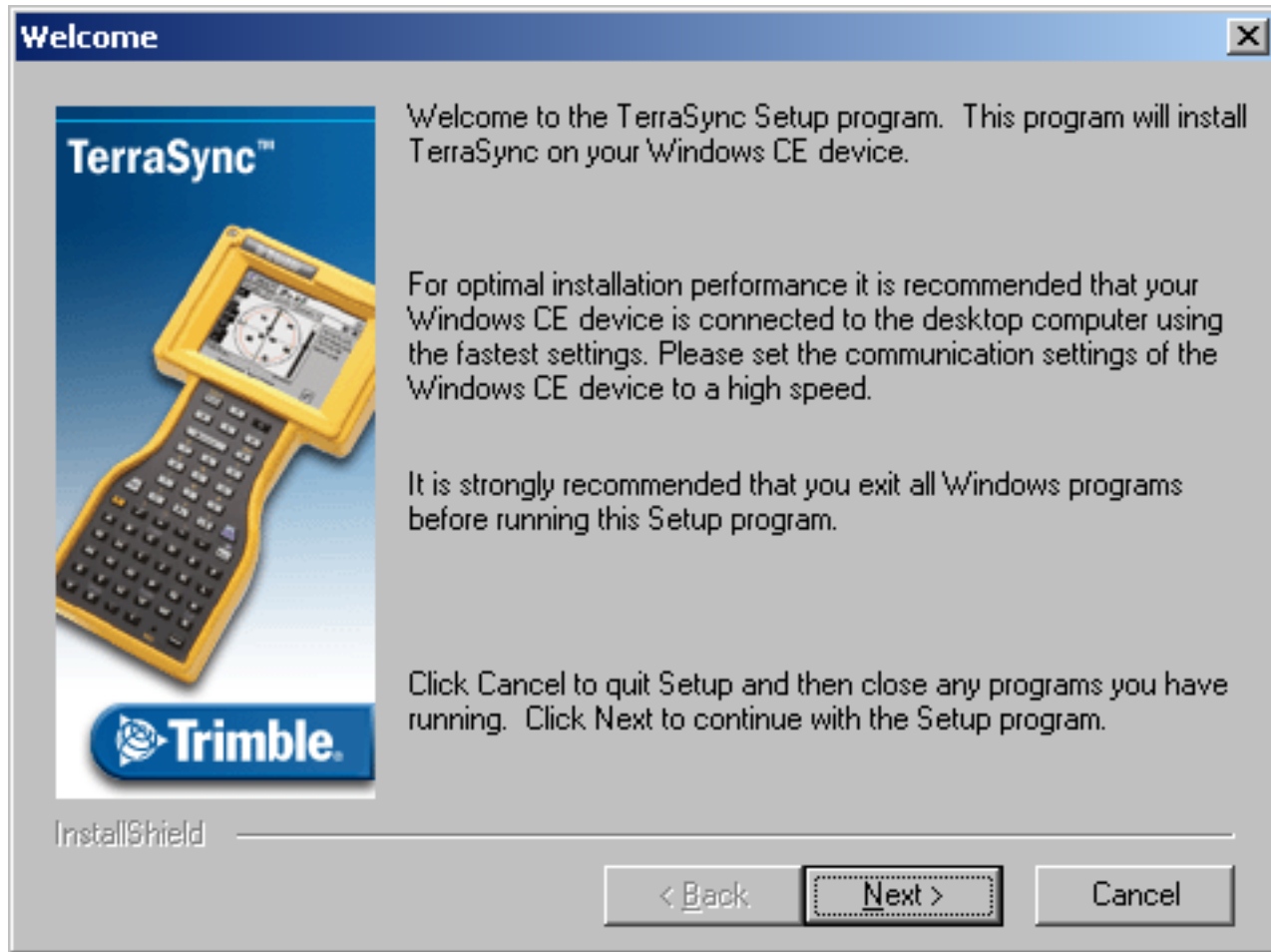

10. Follow the instructions on the screen to install the TerraSync software. You will need to enter your TerraSync version 2.40 serial number. For more information, see [Registering TerraSync](#).

11. If the message "Trimble TerraSync" is already installed. Do you want to proceed with the re-install/upgrade? appears, click **Yes**.
12. When the message **Install "Trimble TerraSync" using the default application install directory?** appears, do one of the following:
- Click **Yes** to install the software to the default location. TerraSync will be installed in the main memory (RAM) of the CE device. Use this option if you are installing onto:
 - a Trimble Recon™ handheld
 - a CE device that has no secondary storage
 - a CE device that only has *removable* secondary storage such as a CompactFlash card
 - Click **No** to install the software to an internal secondary storage location. Use this option if you are installing onto:
 - a GeoExplorer CE series handheld
 - a GIS TSCe field device
 - a TDS Ranger
 - a Juniper Systems Allegro
 - any other CE device that has an *internal* secondary storage location

TIP — Trimble recommends that you install to a secondary storage location to free up storage and program memory on the CE device.

13. Do one of the following:

- If you clicked **Yes** in Step 12, go to Step 14.
- If you clicked **No** in Step 12, the Select Destination Media dialog appears. From the Save In list, select Disk, then click **OK** to proceed with the installation.

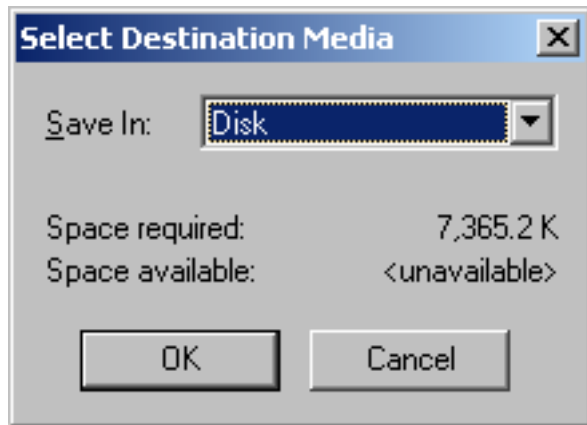

14. Respond to any messages that appear:

- If a message appears on the CE device stating that TerraSync is already installed, and asking if you want to reinstall TerraSync, tap **Yes**.
- If the message **Confirm ignore missing file** appears on the CE device, tap **Yes to All**.
- If the message **Install "Trimble TerraSync" to \Disk\Trimble TerraSync\ ?** appears on the CE device, tap **OK**.

15. When the installation procedure is complete, perform a soft reset on the CE device.

NOTE — When you install TerraSync on a GeoExplorer CE series handheld, some settings are stored in the main memory (RAM), even though TerraSync is always installed to the Disk. To avoid data loss, the installation program automatically backs up the main memory immediately after installing TerraSync.

To transfer files between a desktop computer and the CE device, you must have one of the following installed on the desktop computer:

- the Trimble Data Transfer utility, which is available for free download from the Trimble website at www.trimble.com/datatransfer.html
- version 3.00 or later of the GPS Pathfinder Office software

You must also have **ActiveSync** installed. Ensure that all necessary software is installed before using the TerraSync software.

NOTE — You cannot use Data Transfer to transfer Shapefiles.

Installing translations on a CE device

The TerraSync software is available in several languages. Language files for translated installations are not supplied on the TerraSync Software & Operation Guide CD; they must be downloaded from the Trimble website. The TerraSync setup program uses the **TerraSync Updater utility** to automatically download and install language files.

Trimble recommends that you only install a TerraSync translation on a CE device that has the corresponding language version of the operating system installed. For example, install Japanese TerraSync on a CE device that has Japanese Windows CE installed. System commands (such as the **OK** and **Cancel** buttons) are generated by the operating system, so they appear in the language of the operating system on the CE device.

If you use TerraSync on a CE device that does not have the corresponding translation of the operating system installed, system commands are not translated. Also, some characters may not be interpreted or displayed correctly. For best results, make sure that the TerraSync and operating system languages match. If they do not, install any font that is supplied with TerraSync for that language. For more information, see **Installing fonts on a CE device**.

TIP — If you see squares or unusual characters instead of characters from the appropriate language, you need to install a font.

NOTE — The Regional Options item in the Control Panel only changes the display of date, time, units, and currency information. It does not change the language of the field computer's operating system.

To install a translation of TerraSync on a CE device:

1. Install the English version of TerraSync. For installation instructions, see [Installing on a CE device](#).
2. Use the TerraSync Updater utility to download and install the appropriate language file. The Updater utility is available:
 - as part of the English TerraSync installation. When the TerraSync Updater step appears towards the end of the installation, select the Check for updates now option.
 - on the version 2.40 TerraSync Software & Operation Guide CD.
 - for free download from the Trimble website. Go to www.trimble.com/support.html, and then click **TerraSync / Downloads / v2.40 Software / v2.40 - TerraSync Updater Utility (English)**.

If necessary, install the appropriate font. See [Installing fonts on a CE device](#).

Installing fonts on a CE device

You must install a TerraSync language font if both of the following are true:

- You have installed TerraSync in one of the following languages:
 - Chinese
 - Japanese
 - Korean
- The language version of the operating system does not match the TerraSync language (for example, if you have installed Japanese TerraSync onto an English CE device).

CAUTION — *Do not* install the Japanese font on a CE device that has the Japanese version of Windows CE installed. This can cause software errors on the CE device.

TIP — The Trimble GPS Pathfinder font is installed automatically when you install TerraSync. This font includes symbols that you can use to represent point features on the map. If you want to use other symbol fonts for point features, install the additional fonts manually.

To install a TerraSync language font on a CE device:

1. Uninstall any previous versions of the font.
2. Make sure that you have enough free memory to install the font. TerraSync language fonts require 9–10 MB of free memory. For more information, see [Installing on a CE device](#).
3. Run the TerraSync setup program from the TerraSync Software & Operation Guide CD.
4. Select the Install option.
5. Select the Install fonts option.
6. Select the option for the language you require.
7. Follow the instructions on the screen to install the font.

CAUTION — Always install TerraSync fonts to RAM (main memory). Do not install fonts to a secondary internal storage location (such as a GeoExplorer CE series handheld's Disk or a TDS Ranger's Disk), or to a removable storage device.

8. When the installation is complete, perform a **soft** reset of the CE device.

For information on how to perform a soft reset, refer to the documentation for the CE device.

CAUTION — On some CE devices, you cannot delete Asian language fonts in the usual way. To remove such fonts, you may need to perform a hard reset of the CE device. A hard reset removes **all** software that is not pre-installed on the CE device by the manufacturer.

Installing TerraSync on a PC

You can install TerraSync directly onto a PC. These installation instructions cover:

- **Equipment required for installation**
- **Installing on a PC**
- **Installing on a different PC**
- **Installing translations on a PC**

Equipment required for installation

If the PC that you want to install the TerraSync software on (the target PC) has a CD-ROM drive, or has network access to a CD-ROM drive, you can install TerraSync directly onto that PC. Otherwise, you need to transfer the necessary files to the target PC and then complete the installation on that PC.

To install the TerraSync software onto the *same* PC that you are running the setup program on, the PC must meet the **Field computer specifications** for installing TerraSync. The PC must also have a CD-ROM drive, or access to a CD-ROM drive over a network.

To install the TerraSync software onto a *different* PC:

- the target PC must meet the **Field computer specifications** for installing TerraSync.
- the *office computer* (the PC that you are running the setup program on) must have a CD-ROM drive, and Windows 95, 98, Me, NT, 2000, or XP installed
- you also need a removable storage device that has a capacity of at least 7 MB, and that can be connected to both computers (for example, a Zip drive or a CompactFlash card)

Installing on a PC

NOTE — Trimble recommends that you uninstall any previously installed versions of the TerraSync software (including evaluation software), and transfer any TerraSync data files to a safe storage location, before installing the latest version. If you do not uninstall a previous version, you *must* install the TerraSync software to the same location.

TIP — To install TerraSync on a PC that does not have access to a CD drive, follow the instructions in [Installing on a different PC](#).

To install the TerraSync software:

1. Make sure that you have registered TerraSync and have received a valid serial number by e-mail. For more information, see [Registering TerraSync](#).
2. Make sure that the TerraSync software is not running on the computer.
3. Insert the TerraSync CD-ROM in the CD drive of the computer.
4. The Setup screen appears. If this screen does not appear, select msetup.exe from the CD drive folder.
5. Select the Install option.
6. Select the Install to this PC option.

The TerraSync installation wizard appears:

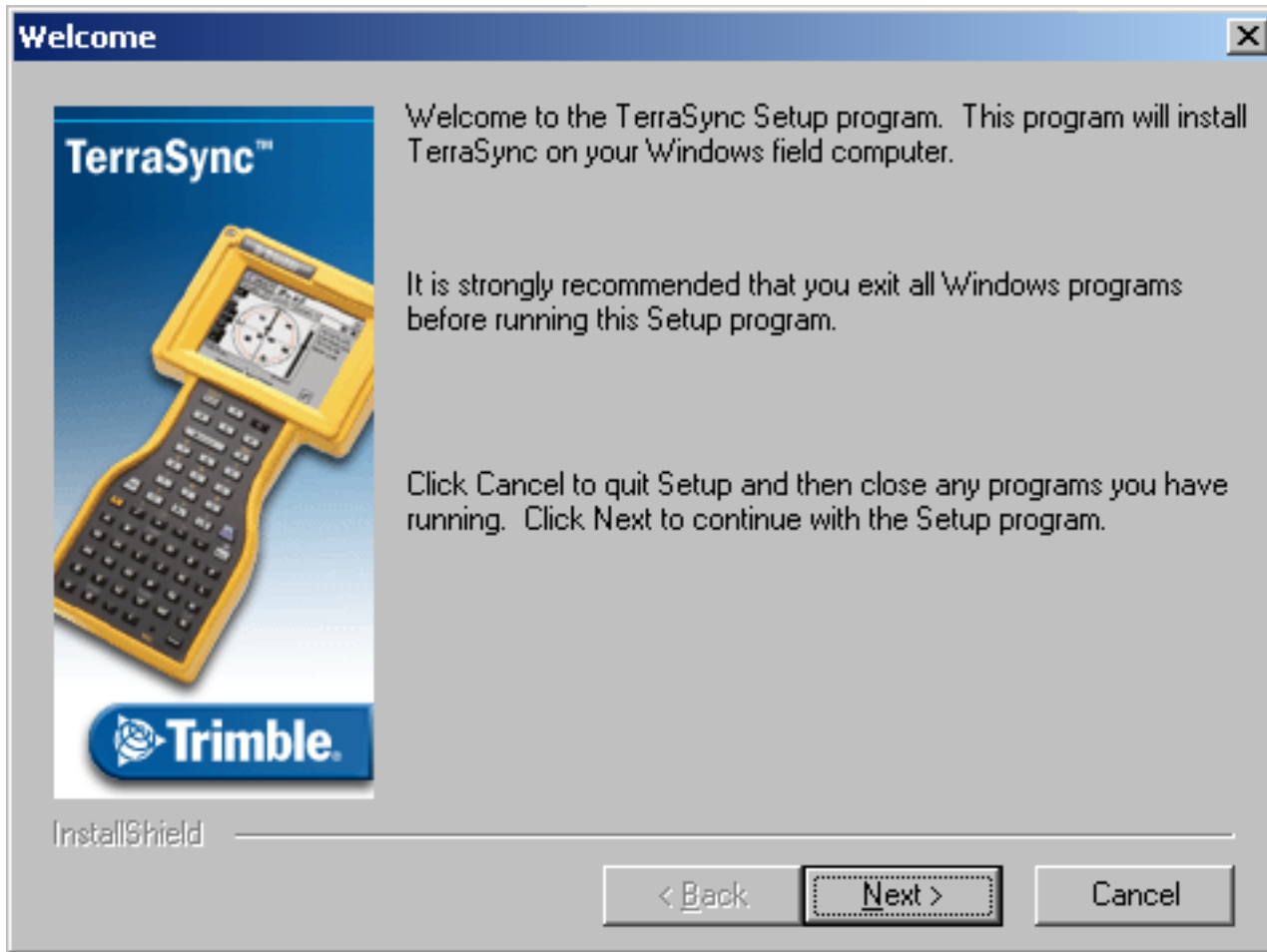

7. Follow the instructions on the screen to install the TerraSync software. You will need to enter your TerraSync version 2.40 serial number. For more information, see [Registering TerraSync](#).

Ensure that all necessary software is installed before using the TerraSync software.

NOTE — To transfer TerraSync files between a desktop computer and the PC that TerraSync is installed on, you must have one of the following installed on the desktop computer:

- the Trimble Data Transfer utility, which is available for free download from the Trimble website at www.trimble.com/datatransfer.html
- version 3.00 or later of the GPS Pathfinder Office software

NOTE — You cannot use Data Transfer to transfer Shapefiles.

Installing on a different PC

If the PC that you want to install the TerraSync software on does not have access to a CD-ROM drive, either locally or across a network, use a removable storage device to transfer the necessary setup files from the TerraSync CD in the office computer's CD-ROM drive to the target PC. Then run the setup program on the target PC.

To install TerraSync on a PC that does not have access to a CD-ROM drive:

1. Connect the removable storage device to the office computer.
2. Insert the TerraSync CD-ROM in the CD drive of the office computer.
3. Using Windows Explorer, locate the Install\PC folder on the CD and copy the PC folder to the storage device.
4. Disconnect the storage device from the office computer and connect it to the target PC.
5. Use Windows Explorer to copy the PC folder from the storage device to the target PC.
6. On the target PC, locate the PC folder and run setup.exe.
7. Follow the instructions on the screen to install the TerraSync software. You will need to enter your TerraSync version 2.40 serial number. For more information, see [Registering TerraSync](#).

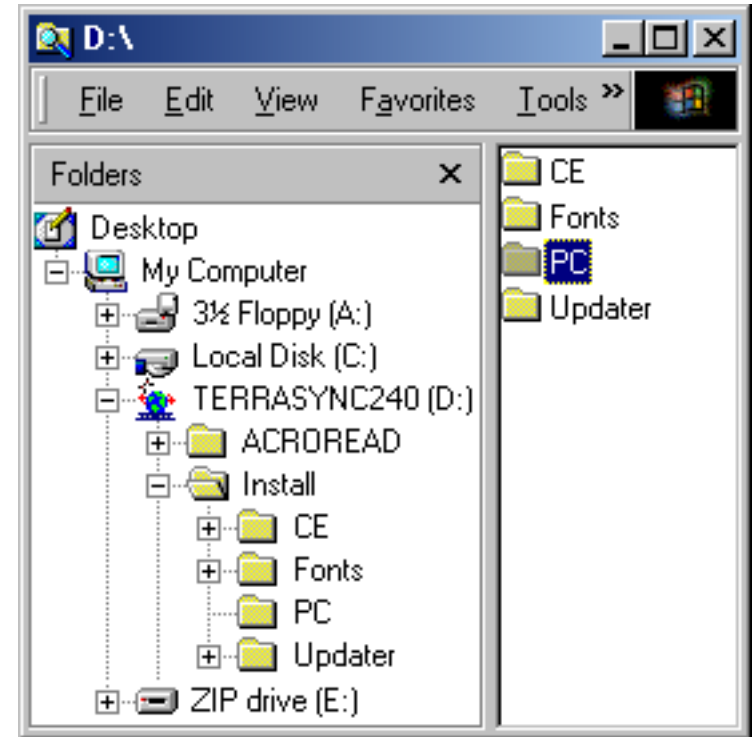

TIP — If you want to use the TerraSync Operation Guide, the TerraSync Release Notes, or the [TerraSync Updater utility](#) in the field, copy the entire contents of the CD to the target PC. You do not need to copy Install\CE or Install\Fonts, because these folders contain files that are only used for Windows CE installations.

Installing translations on a PC

The TerraSync software is available in several languages. Language files for translated installations are not supplied on the CD-ROM, so the setup program uses the **TerraSync Updater utility** to automatically download the necessary files.

Trimble recommends that you install a TerraSync translation only on a PC that has the corresponding language version of the Microsoft Windows operating system installed. For example, install Japanese TerraSync on a PC with Japanese Windows installed. System commands (such as the **OK** and **Cancel** buttons) are generated by the operating system, so they appear in the language of the operating system on the PC. If you use TerraSync on a PC that does not have the corresponding translation of the operating system installed, system commands are not translated.

NOTE — The fonts that TerraSync uses are included with translated Windows operating systems, so you do not need to install them on the PC.

NOTE — The Regional Options item in the Control Panel only changes the display of date, time, units, and currency information. It does not change the language of the operating system.

To install a translation of TerraSync on a PC:

1. Install the English version of TerraSync. For installation instructions, see **Installing on a PC**.
2. Use the TerraSync Updater utility to download and install the appropriate language file. The Updater utility is available:
 - as part of the English TerraSync installation. When the TerraSync Updater step appears towards the end of the installation, select the Check for updates now option.
 - on the version 2.40 TerraSync Software & Operation Guide CD.
 - for free download from the Trimble website. Go to www.trimble.com/support.html and then click **TerraSync / Downloads / v2.40 Software / v2.40 - TerraSync Updater Utility (English)**.

TerraSync Updater utility

Use the TerraSync Updater utility to download the latest software updates, language files, and documentation from the Trimble website. Once you have downloaded files, you can install them immediately, or you can run the Updater utility later and select the downloaded files that you want to install. Your TerraSync license determines which files you can download from the Trimble website.

To download or install files using the TerraSync Updater utility:

1. Run the Updater utility. Do one of the following:
 - When the TerraSync Updater screen appears during installation of the TerraSync software, select the Check for updates now option.
 - Insert the TerraSync CD-ROM in the CD drive of the computer where TerraSync is installed, or in the CD drive of the computer that you used to install TerraSync to a CE device. The Setup screen appears. Select Download/Install Updates.
2. Follow the instructions on the screen to select the files to download and install. You will need to enter your TerraSync version 2.40 serial number. For more information, see [Registering TerraSync](#).

For more information, refer to the TerraSync Updater utility Help.

TUTORIAL

This tutorial provides step-by-step instructions for some of the tasks that you will perform when using the TerraSync software.

The tutorial is divided into five parts: three relate to data collection, and two relate to real-time data update.

Data collection:

- **Preparing for data collection**
- **Data collection**
- **Processing the data**

Data update:

- **Preparing for data update**
- **Data update**

NOTE — You cannot update imported data files using the **TerraSync Standard edition software**. If you have TerraSync Standard edition installed, you cannot perform the data update part of the tutorial.

The tutorial helps you master the main concepts and tasks involved in using the TerraSync software. It is based on the following scenario:

The Seaview Authority maintains a GIS of its street signs, streets, and neighborhood parks for inventory purposes. Information needs to be collected about each entity, indicating its condition and other important information. You and your field crew are responsible for collecting new data and updating the existing GIS data for Starfish Bay.

- Data collection

In this part of the tutorial you collect new features. First, you create a GPS Pathfinder Office project and prepare your equipment for data collection. Then you go to Starfish Bay where you record new features and their attributes. When you return to the office, you postprocess the data you collected, to achieve better positional accuracy for your results. Then you export the data to the Seaview Authority GIS.

- Data update

In this part of the tutorial you update existing GIS data. Some time has passed since you collected the features, so you need to go back and update their attributes. Before going back to Starfish Bay, you import data from the Seaview Authority GIS into the GPS Pathfinder Office software, transfer it to your field computer, and prepare for data update. Finally you return to the field and navigate to existing features to update their attributes. You use the TerraSync software and a <Glossary>real-time differential GPS source to navigate back to features and update their attributes.

Preparing for data collection

Before going to Starfish Bay to collect data, you need to create a new project in the GPS Pathfinder Office software. Then you need to check your equipment to make sure that you are ready to go out into the field. This section provides step-by-step instructions that will prepare you for data collection. The topics are:

- **Creating a project**
- **The Seaview data dictionary**
- **Checking the equipment**

Creating a project

The GPS Pathfinder Office software provides a set of tools for processing and managing GPS and GIS data. The GPS Pathfinder Office software lets you plan your data collection session easily and process the GPS data successfully.

Use the GPS Pathfinder Office software to organize work into projects. Dividing the work in this way helps you manage your files. You can give all projects meaningful names, and assign separate folders for base, export, and backup files. You can also set up projects for different groups of data. For example, you could create a project for each subdivision in the city, or for each month.

For this tutorial, you need to create a new project called TerraSync Tutorial.

To create a project in the GPS Pathfinder Office software:

1. Click  on the Windows taskbar, and then select Programs / GPS Pathfinder Office.

A Trimble identification screen appears while the program is loading. This is followed by the GPS Pathfinder Office application window.

2. By default, the Select Project dialog appears. If it does not appear, from the File menu select Projects.

3. Click **New**. The Project Folders dialog appears:

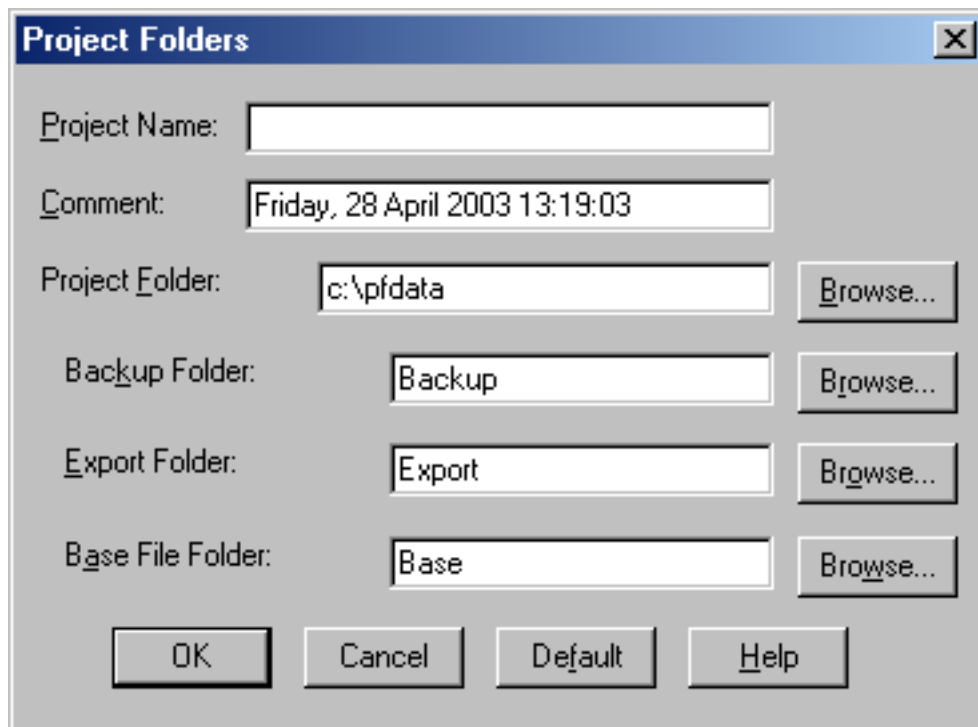

4. In the Project Name field, enter **TerraSync Tutorial**, and then click **OK**.

The Project Folder field is updated to show the default folder for the new project.

5. Click **OK** again to close this dialog and create the new project.

6. In the Select Project dialog, TerraSync Tutorial is selected in the Project Name field. Click **OK** to open the new project.

For more information, refer to the GPS Pathfinder Office Help.

The Seaview data dictionary

A data dictionary contains a description of the features and attributes relevant to a particular project or job. It is used in the field to control the collection of a **feature** and its **attributes**.

The signs, roads, and parks in Starfish Bay that you need to map are *features*. The different types of information that you record for each type of feature are *attributes*. For example, the condition of a sign, or the name of a park, would be an attribute.

To ensure that the data you collect in the field is in the correct format for the Seaview Authority GIS, you need to use a data dictionary that contains the same features and attributes as the Seaview Authority GIS. The Seaview.ddf data dictionary has already been created for this purpose. When you installed the TerraSync software on your field computer, this file was automatically installed.

Checking the equipment

Before going out into the field with the TerraSync software, check that you have all the necessary GPS hardware, batteries, and cables.

The TerraSync Release Notes provide cabling diagrams for the Trimble GPS receivers that the TerraSync software can connect to.

Before you leave the office, Trimble recommends that you:

- set up your entire GIS/GPS data collection system and test it to make sure that everything is connected correctly
- make sure that the receiver and field computer batteries are charged
- make sure that the field computer and GPS receiver are communicating correctly

CAUTION — After testing the system, turn off the field computer and any other equipment (such as radios) before proceeding to the start point of your field work. Leaving equipment on wastes battery life, especially if it will be some time before you need to use the equipment.

TIP — When you turn off the field computer, any receiver that is connected to it is automatically turned off.

Data collection

This part of the tutorial uses the Seaview data dictionary that is already installed on your field computer. You are ready to go to Starfish Bay and collect features. But first there are some tasks that you should complete. This section explains the tasks and gives the step-by-step instructions required to collect point, line, and area features, with a variety of different attributes. The topics are:

- **Initial tasks**
- **Collecting new data**

NOTE — To complete this part of the tutorial, you need to be outside, in a location where you can get good GPS signals. Some TerraSync screens may appear different from the screens shown in this tutorial.

Initial tasks

Before starting a data collection session, you need to perform certain tasks. They are:

- Starting the TerraSync software
- Getting a clear view of the sky
- Checking the GPS status
- Configuring the GPS slider bar

Starting the TerraSync software

When you get outside, switch on the field computer and start the TerraSync software. The GPS receiver should start automatically when you start TerraSync.

Tap  Start and then select Programs / TerraSync. While the software is loading, a Trimble identification screen appears.

The **Skyplot screen** in the Status section appears after the identification screen.



Getting a clear view of the sky

Move to a location where you have a clear view of the sky.

Signals can be received from any direction. Satellite signals can be blocked by people, buildings, heavy tree cover, large vehicles, or powerful transmitters. Anything that blocks light also blocks signals. GPS signals can go through leaves, plastic, and glass, but these all weaken the signal.

Checking the GPS status

When you start the TerraSync software, it automatically connects to the GPS receiver. TerraSync then begins to track visible satellites and to calculate its current position. Use the satellite icon on the **Status bar** to check whether the receiver is computing GPS positions. This icon provides information about the geometry of the satellites that are being used to compute GPS positions.

Use the Status section to view the satellites currently tracked and those that are being used to calculate the current position.

NOTE — For more information about satellite geometry and how this can affect GPS data collection, visit the Trimble website at www.trimble.com.

To view the GPS status:

1. The Skyplot appears when you first run the TerraSync software. If this screen is not visible, tap the Section list button and select Status. Then tap the Subsection list button and select Skyplot.

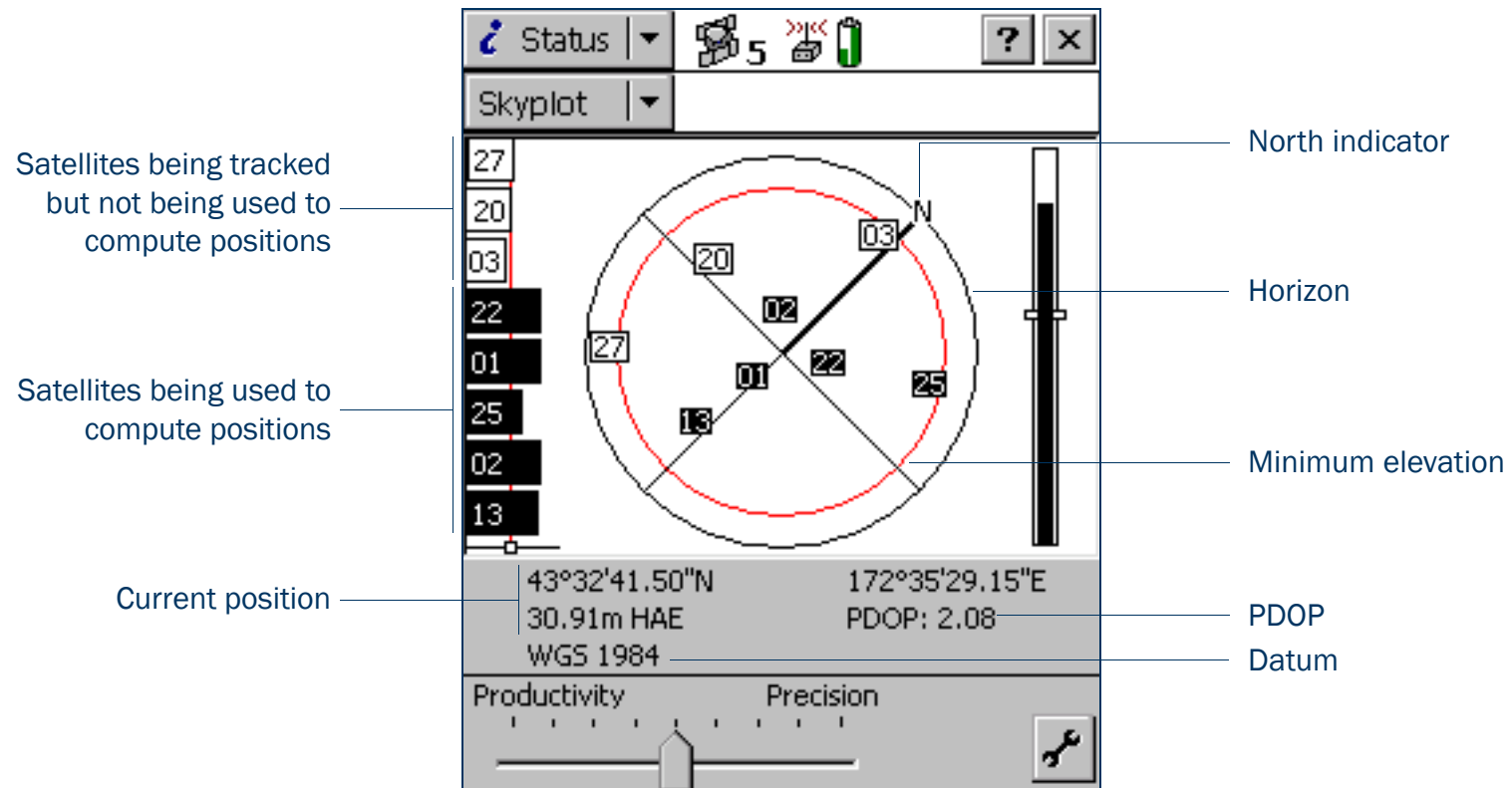

2. Use the skyplot to see which satellites are being tracked, and to see your current position.

Filled (black) boxes represent satellites that the receiver is using to compute its current GPS position. Unfilled (white) boxes represent satellites that the receiver is getting signals from but is not using because the signals are too weak. In the above example, eight satellites are being tracked and five of these satellites are being used to compute GPS positions.

NOTE — Numbers with no box represent satellites that are available, but that the TerraSync software is not receiving signals from.

Your current GPS position is displayed at the bottom of the screen.

TIP — For detailed information on satellite positions and signal strengths, use the **Satellite information screen** in the Status section.

You need a minimum of four satellites, with good geometry, to compute a 3D GPS position. When you turn on the receiver, it automatically starts to track visible satellites and to calculate its current position. If the receiver is computing GPS positions, the satellite icon in the **Status bar** and the number beside the icon are solid. If the satellite or its number are flashing, the satellite geometry is poor or there are too few satellites available to compute GPS positions. Adjust the **GPS slider** or wait until conditions are more favorable.

Configuring the GPS slider bar

There are some critical settings in the TerraSync software that you must configure before collecting data (for example, the GPS settings). Configure these before leaving the office, or in the field. You can also set other (non-critical) settings to suit your application or preferences.

The following steps show you how to configure the GPS slider bar to best suit the environment of Starfish Bay. Starfish Bay is an open area, with few tall buildings, trees, or other obstructions. Therefore, you need to adjust the GPS slider bar to allow better positions to be recorded. You will record fewer positions because you will restrict logging to locations when there is good satellite geometry, but the positions you record will have higher quality.

NOTE — By default, the GPS slider bar is set at the middle setting. When you adjust the GPS slider bar to the left, you can obtain positions in less favorable conditions that are less precise.

To configure the GPS slider bar:

1. Tap the Section list button, and then select Setup.
2. Tap **GPS Settings**. The GPS Settings form appears.

TIP – Use a high setting on the GPS slider bar whenever a project requires the highest level of precision.

3. Drag the slider control to the right to raise the GPS slider bar two positions.

This lets you collect fewer positions, but they will be more precise. Because there are few obstacles to block your view of the sky, this may provide better overall results. If the slider bar is set too high, the precision of the positions collected is high, but there may be places in the Starfish Bay area that cannot be mapped.

4. Tap **OK** to close the GPS Settings form.

For more information, see [GPS Settings](#).

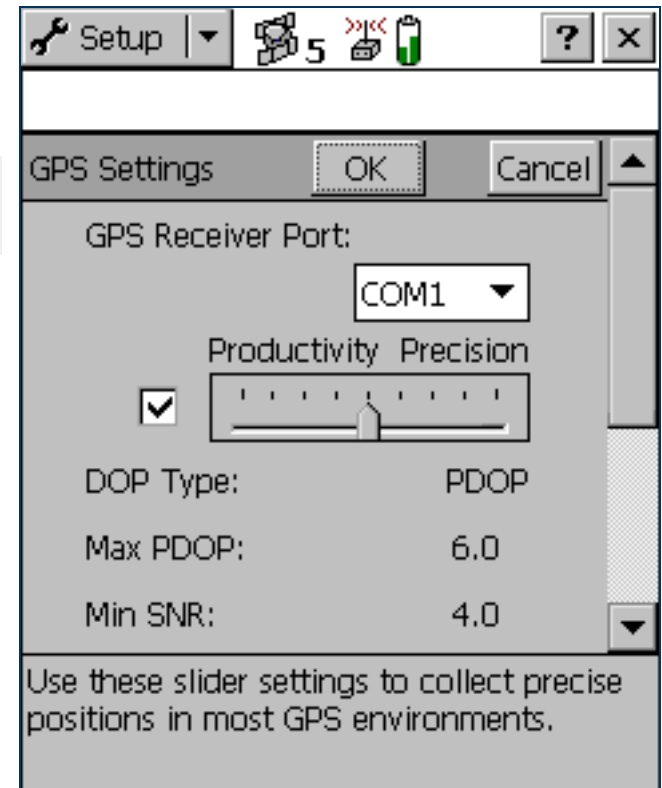

Collecting new data

Your supervisor has sent you to Starfish Bay to map new road signs, roads, and parks. This part of the tutorial gives step-by-step instructions for the following tasks:

- **Creating a new data file**
- **Collecting a point feature**
- **Collecting a line feature with Log Later**
- **Collecting an area feature**
- **Ending the data collection session**

Creating a new data file

Before starting the data collection session, you need to create a new data file to store the new features and attributes you collect. Use the **Data section** to do this.

To create a new file:

1. Tap the Section list button, and then select Data.
2. Tap the Subsection list button, and then select New File. The New File screen appears.
3. The TerraSync software automatically enters a default name in the File Name field. Replace the default name with **Starfish**.
4. In the Dictionary Name field, make sure that the Seaview data dictionary is selected.
5. Tap **Create**.

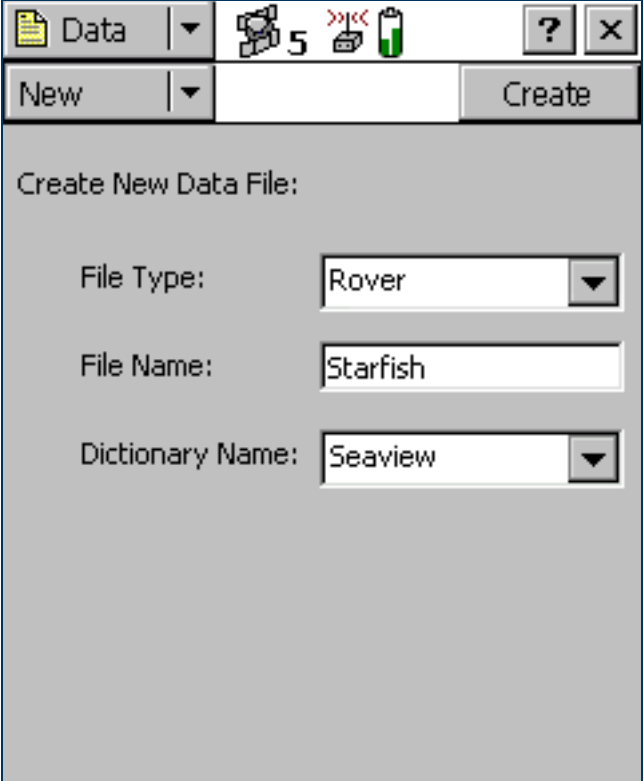

The screenshot shows the 'Create New Data File' interface. At the top, there is a navigation bar with a 'Data' dropdown menu, a 'New' button, and a 'Create' button. Below this, the 'Create New Data File' screen is visible, featuring three input fields: 'File Type' with a dropdown menu set to 'Rover', 'File Name' with a text input field containing 'Starfish', and 'Dictionary Name' with a dropdown menu set to 'Seaview'. The background is a light gray color.

6. The Confirm Antenna Height form appears. If necessary, enter the correct antenna height and measurement point, and then tap **OK**.
7. The Collect Features screen appears. This screen shows a list of all the features in the data dictionary.

You have created a new data file, so you can now start collecting features.

Collecting a point feature

The first new feature you need to record is a road sign. This is a point feature.

To record a point feature, you remain stationary while the TerraSync software logs GPS positions. These positions are averaged to compute the final GPS position of the point feature.

When the TerraSync software is logging GPS positions, the logging icon  appears in the status bar. The number beside the icon indicates how many positions have been logged for the selected feature.

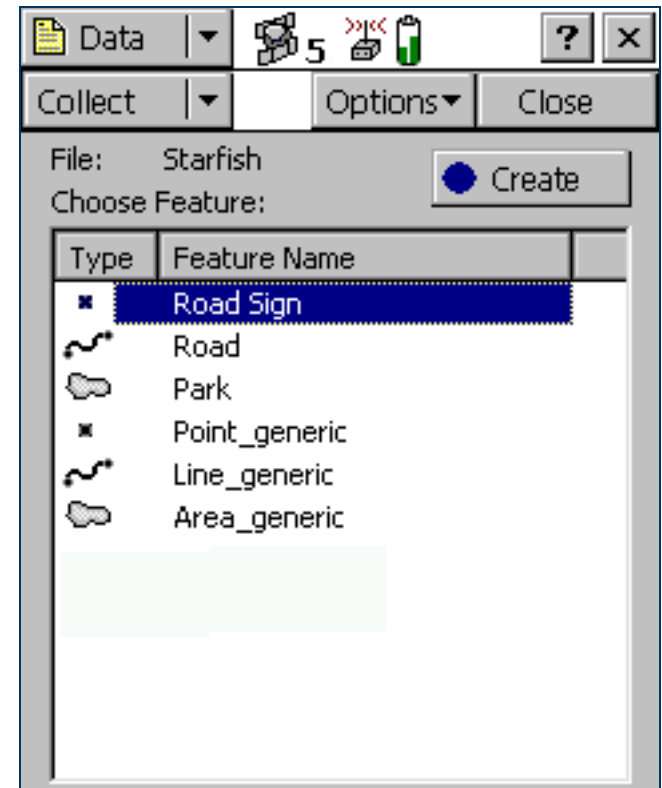

To record a point feature:

1. Make sure that the Collect Features screen is open. If it is not, tap the Section list button, select Data, and then tap the Subsection list button and select Collect Features.
2. In the Choose Feature list, highlight Road Sign, and then tap **Create**. The attribute entry form for the Road Sign feature type appears.
The Date Visited attribute is set to auto-generate on creation, so today's date is automatically filled in. You do not need to enter a value in this field.
3. From the list of options in the Type field, select Stop. These options are the values defined in the data dictionary.
This is a new sign, so its condition is good. Good is selected by default in the Condition field, so you do not need to change this field.
You have now recorded all the attribute information needed for the road sign.
4. As the software logs GPS positions, the counter beside the logging icon increments. When you have finished entering the attributes, tap **OK** to close the road sign feature.
The attribute entry form closes and you are returned to the Collect Features screen.
5. Later in the tutorial, you will navigate back to a sign that needs to be replaced, and update its attributes. You need to collect this road sign feature now. Repeat the above procedure to log another road sign feature. When you get to step 4, change the Condition field to Replace.

The screenshot displays the 'Collect Features' screen in the TerraSync application. At the top, there is a navigation bar with a 'Data' dropdown menu, a 'Collect' dropdown menu, and buttons for 'Options', 'Pause', and 'Cancel'. Below this, the current feature is identified as '1 Road Sign'. The 'Date Visited' field is populated with '6/17/03'. The 'Type' field is empty, and the 'Condition' field is set to 'Good'. There are 'OK' and 'Cancel' buttons at the top right of the form area.

Collecting a line feature with Log Later

The next feature you need to record is a road. This is a line feature. To record a line feature, you need to travel along the line. As you do so, the TerraSync software will record a GPS position at the configured logging interval, which defaults to the value that was set when the feature was created in the data dictionary. These positions are joined together to form a line.

By default, the TerraSync software begins logging GPS positions as soon as you open a new feature. You can use the Log Later option to delay logging of positions until you have entered the attributes for the feature, or until you reach the start of the feature.

To record a line feature with the Log Later option:

1. Make sure that the Collect Features screen is open. If it is not, tap the Section list button and select Data, and then tap the Subsection list button and select Collect Features.
2. In the Choose Feature list, highlight Road.
3. Tap **Options** and select Log Later.
4. Tap **Create**. The Road attribute entry form appears.

You can record the attributes of the road before logging GPS positions.

NOTE — When you use the Log Later option, the pause icon  flashes in the status bar to let you know that the TerraSync software is not logging GPS positions.

5. The Name field is already highlighted. Enter the name of the road, which is **Seagull St**.
6. Seagull Street has two traffic lanes. In the Number of Lanes field, enter the value **2**.
7. Move to the start of the road and tap **Log** to begin logging GPS positions for the road feature. The pause icon disappears from the status bar and the number on the logging icon increments as each position is recorded.
8. Continue down the road. When you reach the end of the line you are logging, tap **OK** to close the road feature.

NOTE — The Log Now and Log Later functions apply to all features you collect.

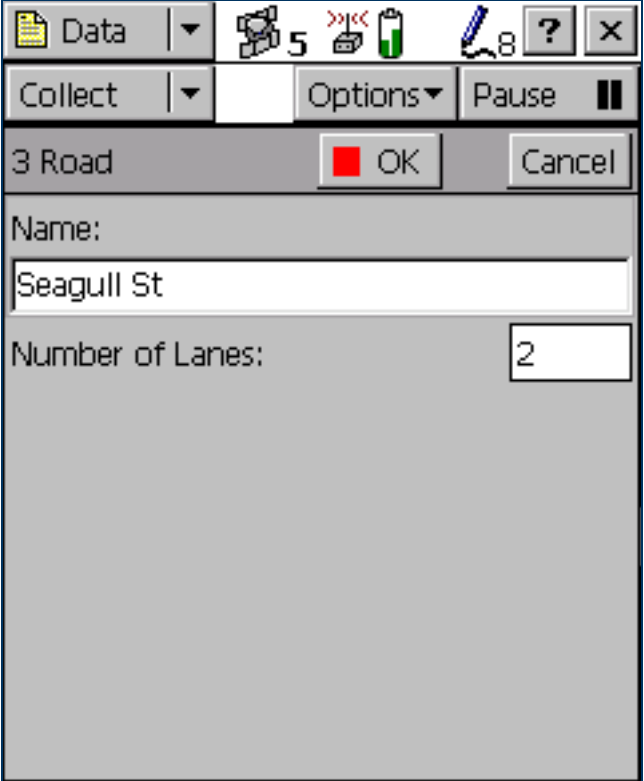

The screenshot shows the TerraSync data collection interface. At the top, there is a status bar with icons for Data, Collect, Options, and Pause. Below the status bar, the text "3 Road" is displayed. To the right of "3 Road" are two buttons: "OK" (with a red square icon) and "Cancel". Below this, there is a form with two fields: "Name:" and "Number of Lanes:". The "Name:" field contains the text "Seagull St". The "Number of Lanes:" field contains the value "2".

Collecting an area feature

Now you need to record the park in Starfish Bay. This is an area feature.

To record an area feature, you need to travel around the perimeter of the area. As you do so, the TerraSync software will log GPS positions at the logging interval set in the data dictionary. These positions are joined together to form the perimeter of the area.

The first and last GPS positions are joined together to close the area, so there is no need to return to the exact start point.

When you logged the road feature, you recorded the attributes before you started to log GPS positions. For the park feature, you will log GPS positions at the same time as you record the attributes.

To collect an area feature:

1. Make sure that the Collect Features screen is open. If it is not, tap the Section list button and select Data. Then tap the Subsection list button and select Collect Features.
2. Tap **Options** and select Log Now.
3. In the Choose Feature list, highlight Park.

4. Tap **Create**.

The attribute entry form for the Park feature opens, and the TerraSync software starts to log positions.

You can pause logging at any time. For example, if you are driving around the perimeter of the park and you want to stop and examine a sign some distance from the park, you can stop logging positions for the park boundary. You can also pause logging if you want some time to enter attribute values.

5. To pause logging, tap **Pause**. The TerraSync software stops logging positions and a pause icon flashes in the status bar. To continue collecting the park feature, tap **Resume** to resume logging. The pause icon disappears.

For more information, see [Pausing and resuming logging](#).

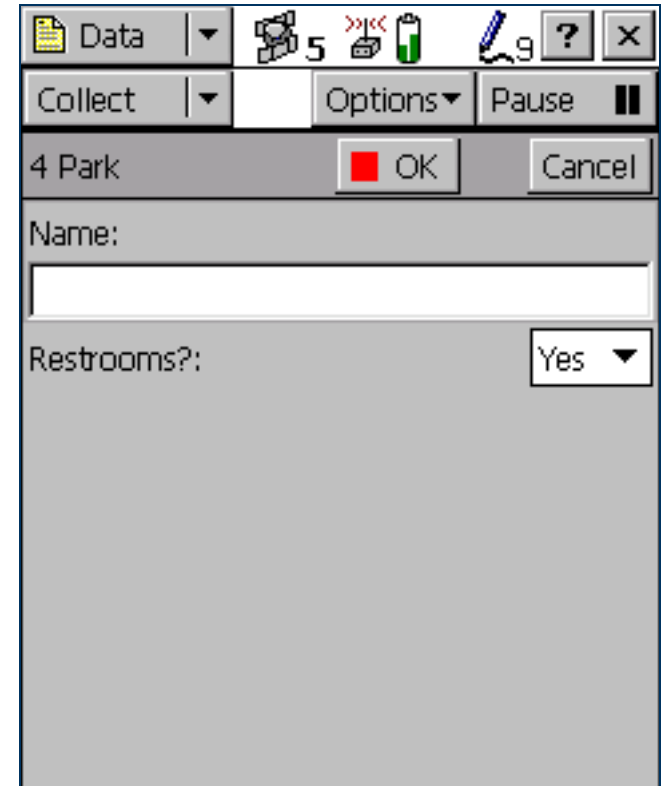

6. You can view the map while collecting features. To do this, tap the Section list button and select Map. The features that you have collected are displayed on the map, along with the park perimeter that you are currently collecting.

You can view the map at different scales. To do this, tap the Zoom In or Zoom Out button on the **Command bar**.

Alternatively, tap the Map Tools list button, select Zoom In or Zoom Out, and then select the point on the map that you want to zoom in or out from.

NOTE — Your Map screen may appear different from the one shown.

7. Tap the Section list button and select Data to go back to the Data section. The Park attribute entry form is still active and the TerraSync software is still logging positions for the park.
8. Enter the park's attributes. In the Name field, enter **Starfish Park**, and from the Restrooms? field, select Yes.
9. When you have walked around the perimeter of the area, tap **OK** to close the feature.

TIP — There are several advanced techniques that make data collection more efficient. For more information, see **Advanced data collection**.

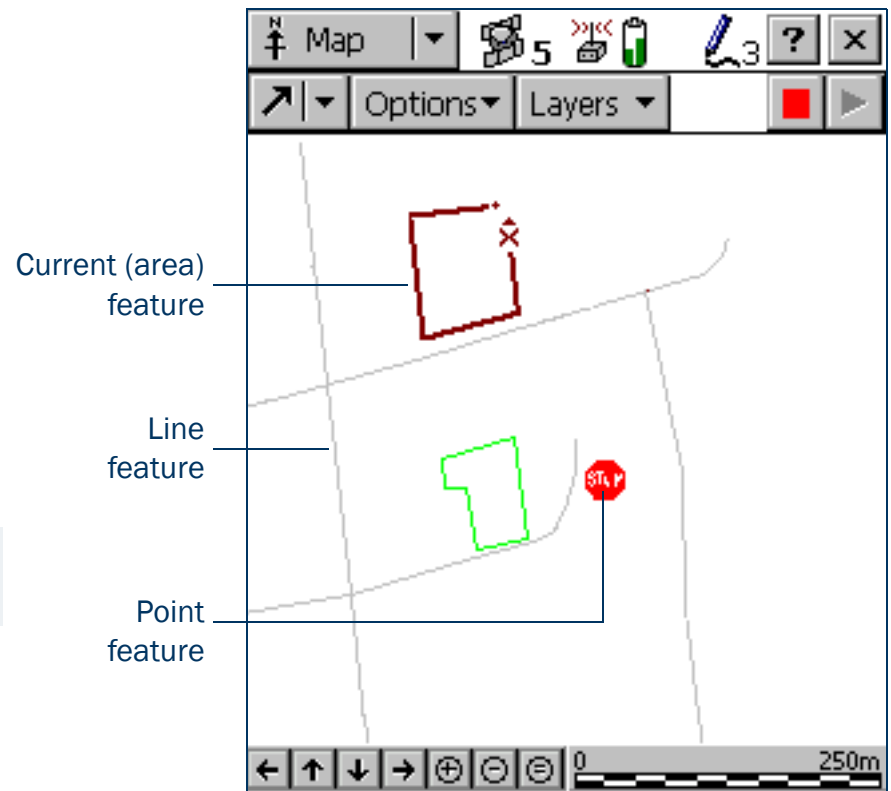

Ending the data collection session

When the data collection session is complete, close the data file and exit the TerraSync software.

To close the open data file and exit the TerraSync software:

1. Tap **Close** in the Collect Features screen.

A message appears, asking you to confirm that you want to close the open file.

2. Tap **Yes** to close the current data file and return to the New File screen.

3. Tap the Close button  in the upper right corner of the screen.

A message appears, asking you to confirm that you want to exit the TerraSync software.

4. Tap **Yes** to exit the TerraSync software.

Processing the data

After the data collection session, use the GPS Pathfinder Office software to process the data collected and transfer it to the GIS.

This part of the tutorial shows you how to transfer and view the data. The topics are:

- Transferring data to the office computer
- Differentially correcting data
- Viewing data
- Exporting data to a GIS

Transferring data to the office computer

You need to transfer the data you collected in the field from the field computer to the office computer.

To transfer the Starfish Bay data file from the field computer to the office computer:

1. Switch on the field computer and the office computer and connect the two computers.
 - If the field computer is a CE device, the ActiveSync software should automatically establish a connection with the CE device. When ActiveSync is connected to a CE device, the message **Connected** appears in the main ActiveSync window, and the ActiveSync icon in the taskbar is green.
If ActiveSync does not connect automatically, connect to the CE device manually. For information, refer to the ActiveSync help, or see [Troubleshooting](#).
 - If the field computer is a PC, make sure that there is a network connection between the PC and the office computer.
 - If the TerraSync software and the GPS Pathfinder Office software are installed on the same computer, you only need to turn on the computer.
2. In the GPS Pathfinder Office software, select Utilities / Data Transfer. The Data Transfer dialog appears.
3. From the Device list, select the appropriate device (GIS Datalogger on Windows CE or GIS Datalogger on Windows PC). Alternatively, if you have set up a device definition for the field computer, select that device name from the list.

The Trimble Data Transfer utility automatically connects to the field computer.

4. Select the Receive tab.
5. Click **Add** and select Data File from the drop-down list. The Open dialog appears.

NOTE — The files that appear are the files in the TerraSync data folder on the field computer.

6. The Starfish file appears in the list of files. Highlight this file.

7. Check that the Destination field shows C:\Ppdata\TerraSync Tutorial, then click **Open**. The Open dialog disappears and the Starfish file appears in the Files to Receive list.

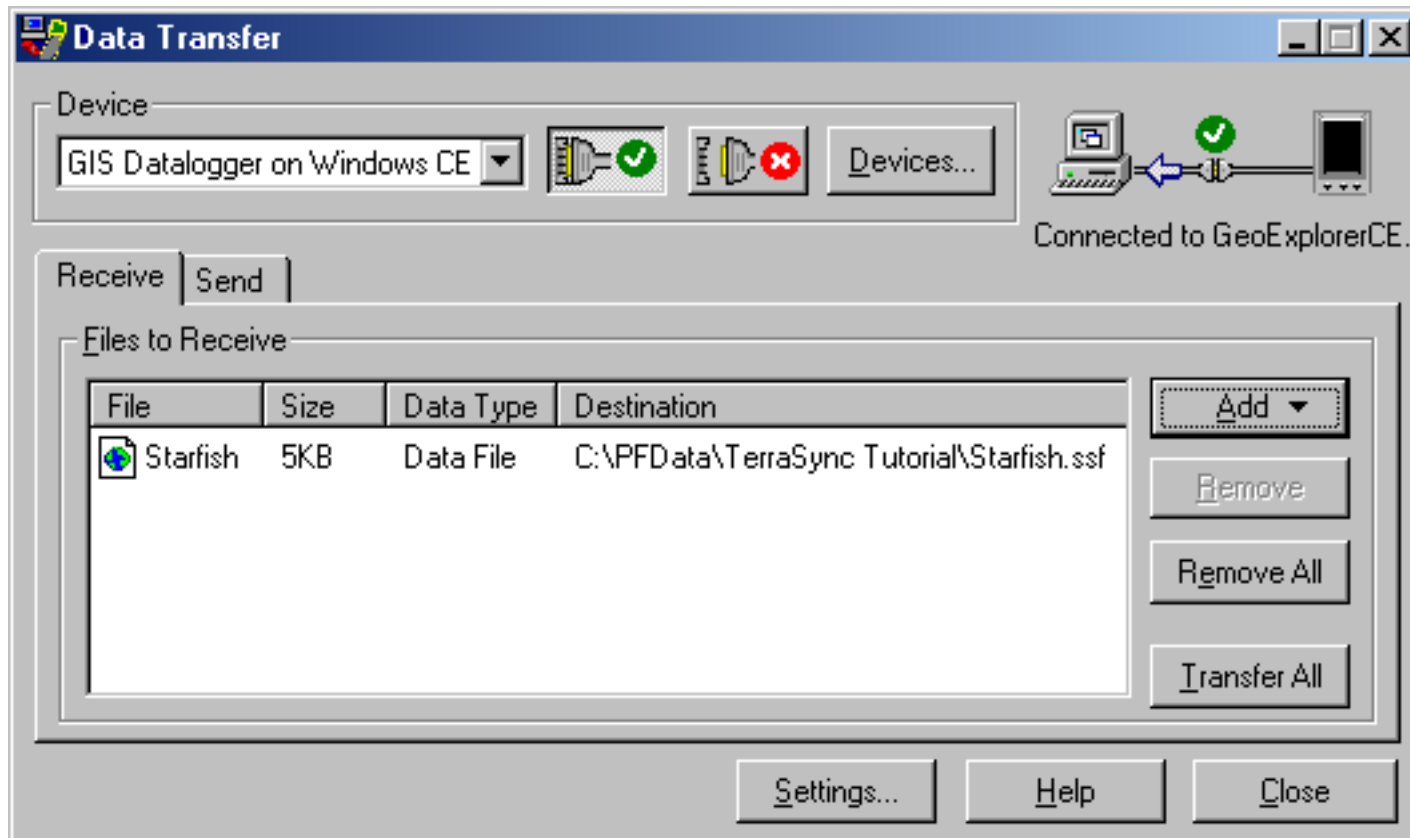

8. Click **Transfer All**. The data file is transferred to the desktop computer.
9. A message box showing summary information about the transfer appears. Click **Close** to close it.
10. Click **Close** to close the Data Transfer utility.

For more information, refer to the GPS Pathfinder Office Help.

Differentially correcting data

The data collected by GPS receivers is subject to errors, including small satellite clock errors, orbit errors, atmospheric noise, and multipath errors. The vast majority of these errors can be removed from the data by **differential correction**. Differential correction improves the accuracy of GPS positions to the specified accuracy of the receiver.

To differentially correct the data file:

1. Start the GPS Pathfinder Office software and open the TerraSync Tutorial project.
2. Select Utilities / Differential Correction to start the Differential Correction utility.

The Differential Correction dialog appears.

3. The file you transferred from the CE device should appear in the Selected Files field. If it does not, click **Browse** and locate the file called Starfish.ssf, and then click **Open**.

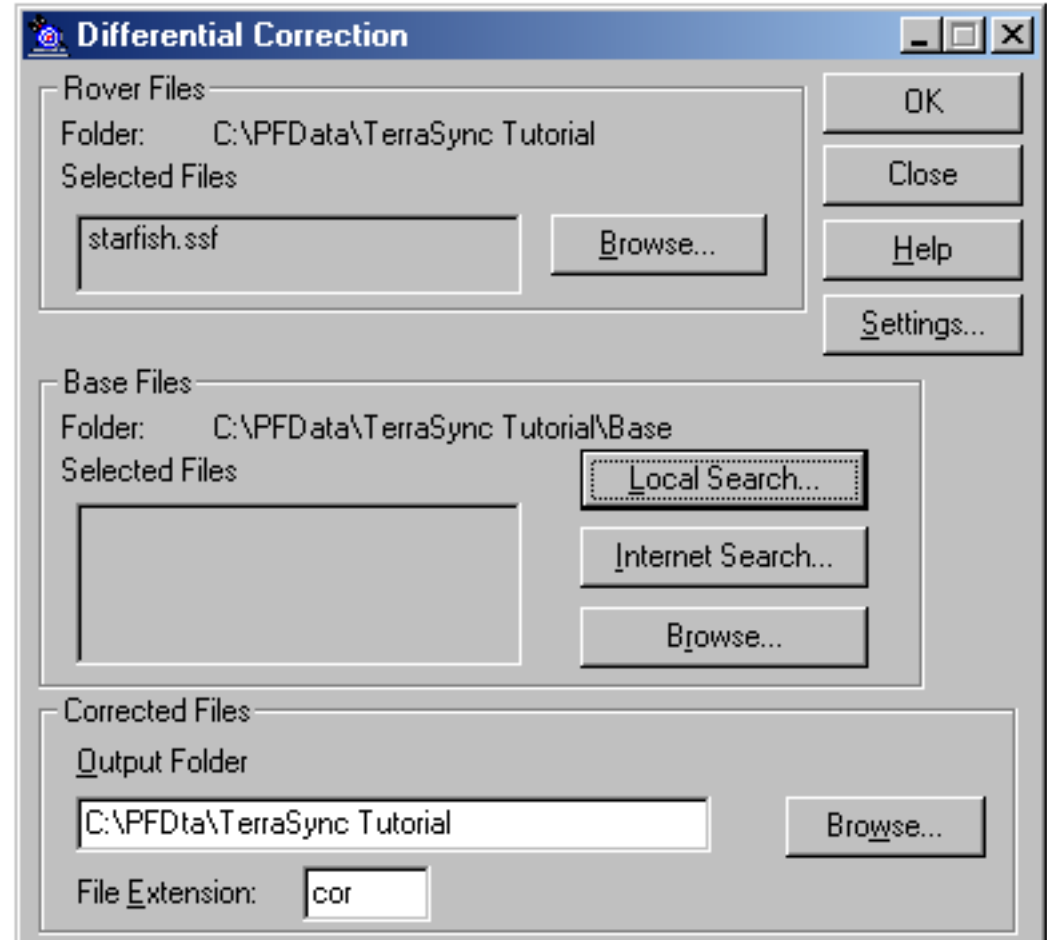

- Specify the location of the base files. Depending on the source of the base files, there are three options: Local Search for base files, Internet Search for base files, or Browse. By default, base files are stored in the current project's base file folder on your local drive. If you need to change the Folder path for the Local Search for base files option, click **Browse**. The Confirm Selected Base Files dialog appears.

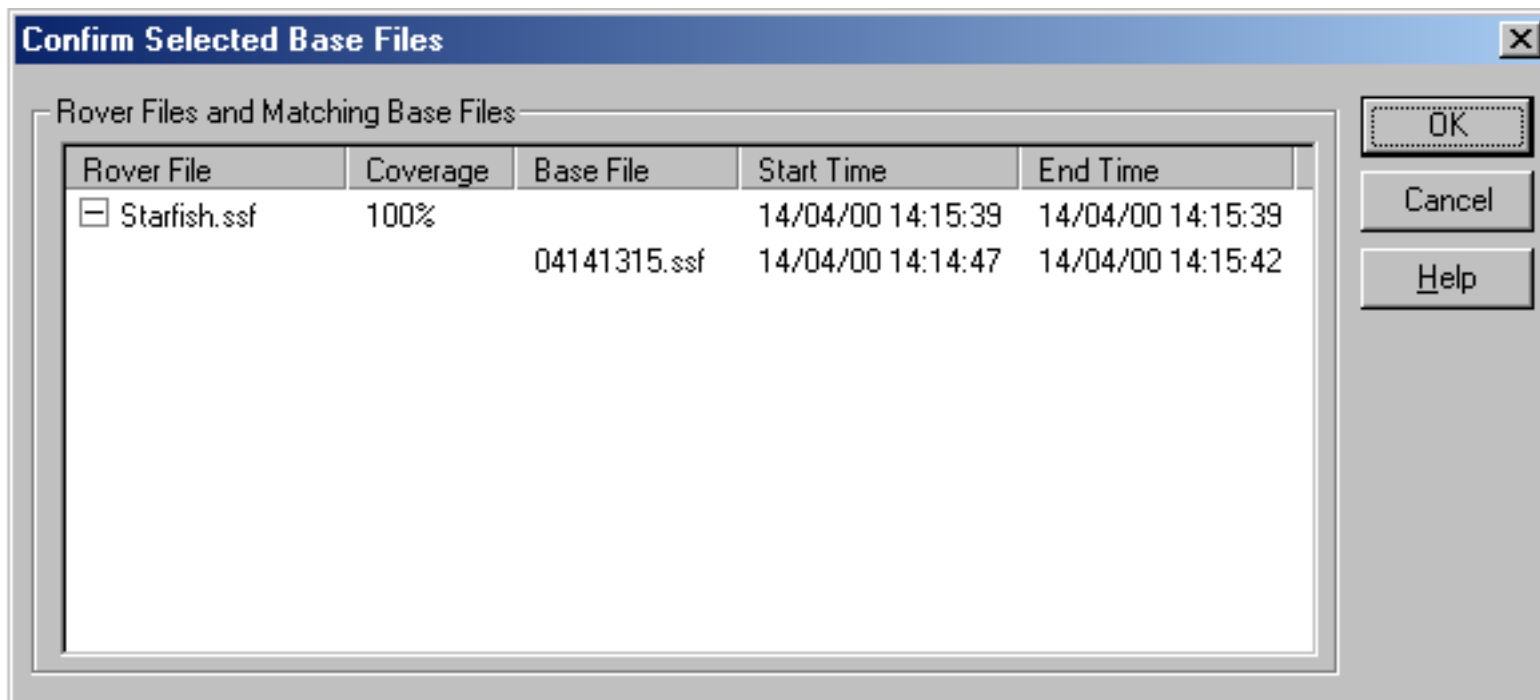

5. Use the Confirm Selected Base Files dialog to make sure that the selected base files provide coverage for the rover files. Click **OK**. The Reference Position dialog appears.

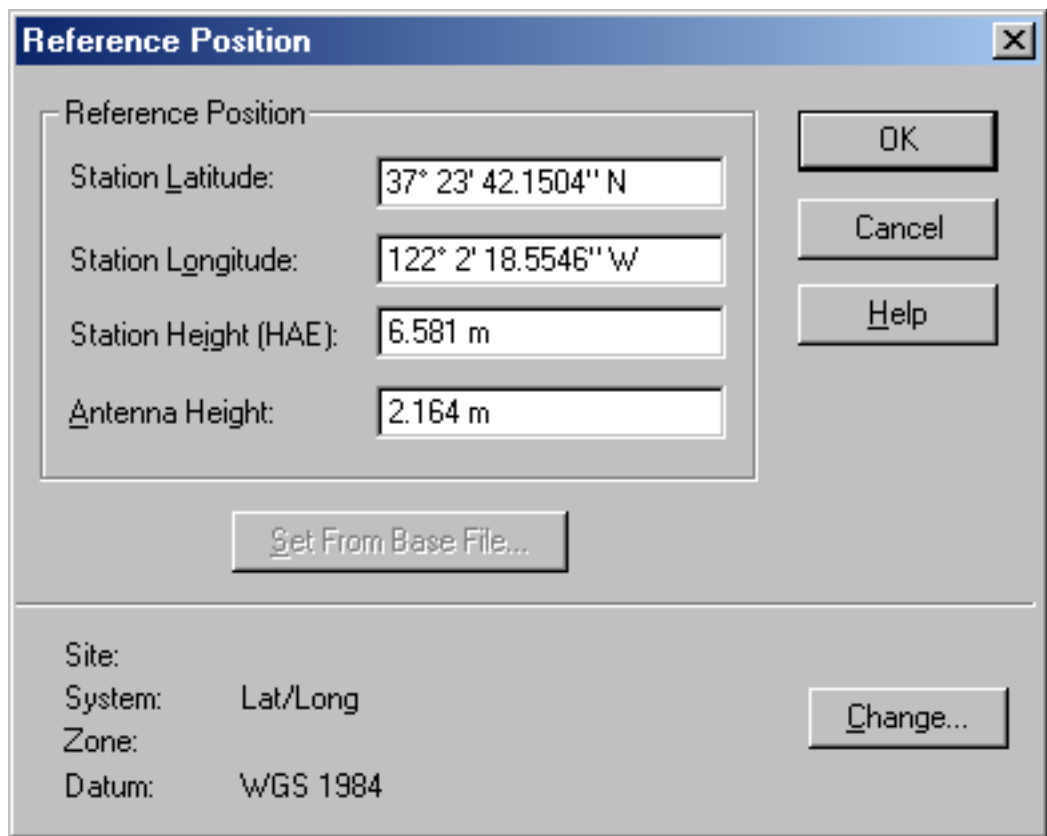

The image shows a software dialog box titled "Reference Position". It contains several input fields and buttons. The input fields are: "Station Latitude" with the value "37° 23' 42.1504'' N", "Station Longitude" with "122° 2' 18.5546'' W", "Station Height (HAE)" with "6.581 m", and "Antenna Height" with "2.164 m". There are three buttons on the right: "OK", "Cancel", and "Help". A "Set From Base File..." button is located below the input fields. At the bottom, there is a section for site information: "Site:" followed by "System: Lat/Long", "Zone:", and "Datum: WGS 1984". A "Change..." button is next to the "System" field.

Reference Position	
Reference Position	
Station Latitude:	37° 23' 42.1504'' N
Station Longitude:	122° 2' 18.5546'' W
Station Height (HAE):	6.581 m
Antenna Height:	2.164 m
Set From Base File...	
Site:	
System:	Lat/Long
Zone:	
Datum:	WGS 1984
Change...	

6. Click **OK** to confirm the reference position.
7. Specify the output folder. By default, the output folder is the current project folder.

8. Select a processing option.

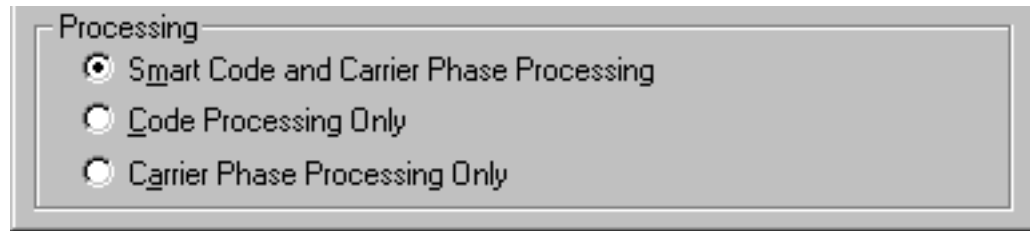

By default, Smart Code and Carrier Phase Processing is selected.

9. Click **OK** to differentially correct the selected files.

10. The Differential Correction Completed dialog details the results of the differential correction. Click **Close** to close this dialog.

For more information about differentially correcting data, refer to the GPS Pathfinder Office Help.

Viewing data

When the data has been transferred and differentially corrected you can display, edit, and plot it using the GPS Pathfinder Office software. The GPS Pathfinder Office Map window is the best way to view field data and to verify its integrity. Use it to make graphical queries and measurements on the collected data. You can specify the colors, symbols, and line styles for each feature.

To view the data:

1. In the GPS Pathfinder Office software, select File / Open. Select the Starfish.cor file. The current project folder is the default path (C:\Pfddata\TerraSync Tutorial).

Starfish.cor is the differentially corrected version of the file Starfish.ssf, which you transferred from the field computer.

2. If the Map window is not visible, select View / Map.

The Map window displays the selected file.

NOTE — Your Map window may appear different from the one shown.

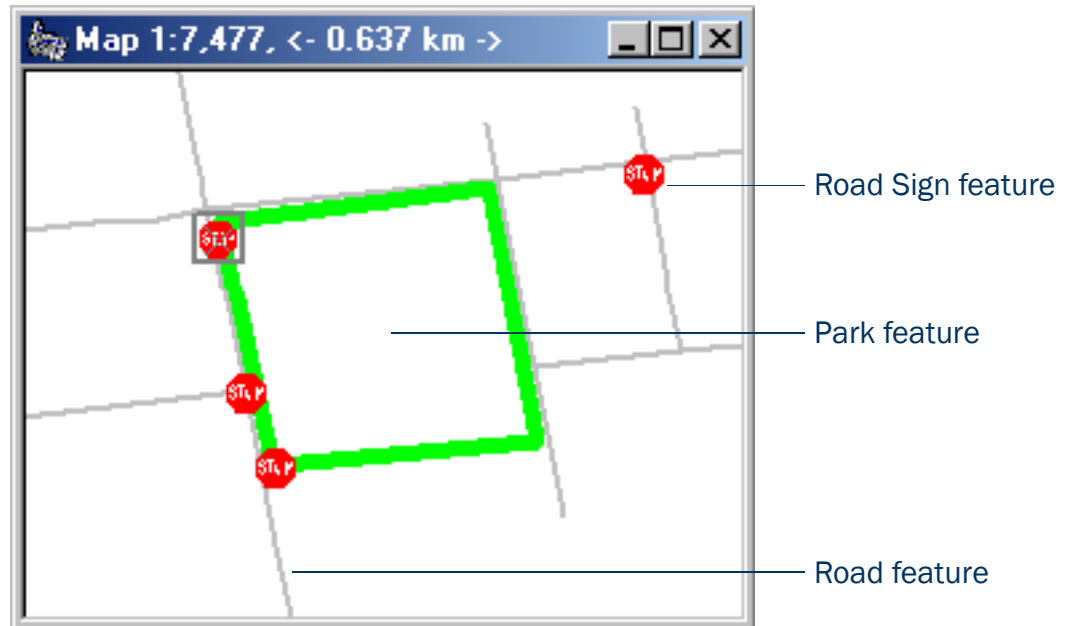

3. To display the attributes of any feature on the map, double-click the feature. The Feature Properties dialog appears. It provides attribute information about the selected feature.
4. Change the color of the Park feature:
 - a. Right-click the Park feature on the map.
 - b. From the shortcut menu that appears, select Park Layer Style.
The Park dialog appears.
 - c. Use this dialog to change the color of the park area to green.

For more information about the GPS Pathfinder Office Map window display, refer to the View menu topic in the GPS Pathfinder Office Help.

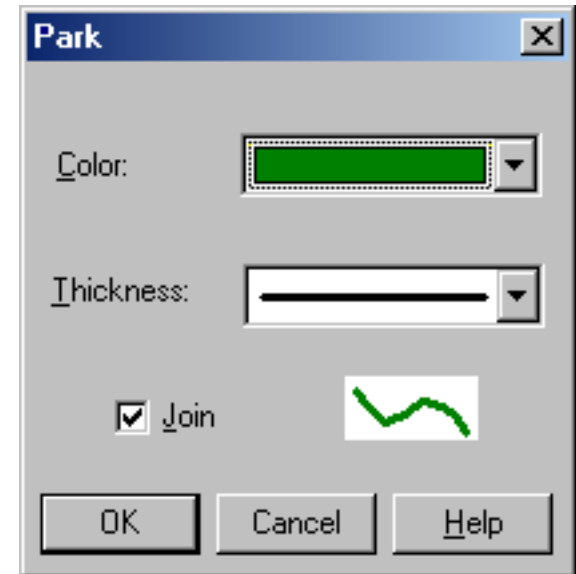

Exporting data to a GIS

The Trimble Export utility in the GPS Pathfinder Office software converts files that are in **SSF** format into a format that can be read by a GIS, CAD, or database system. It lets you export point, line, and area features, attributes, and positions to a variety of other formats.

To export data to a GIS:

1. In the GPS Pathfinder Office software, start the Export utility by selecting Utilities / Export.
2. The file Starfish.cor is displayed in the Selected Files field. If it is not, click **Browse** to display the Open dialog. Browse for Starfish.cor, highlight it, and click **Open**.
3. Select the output folder. By default, this is the export folder in the current project.
4. In the Choose an Export Setup group, select Sample ArcView Shapefile Setup.

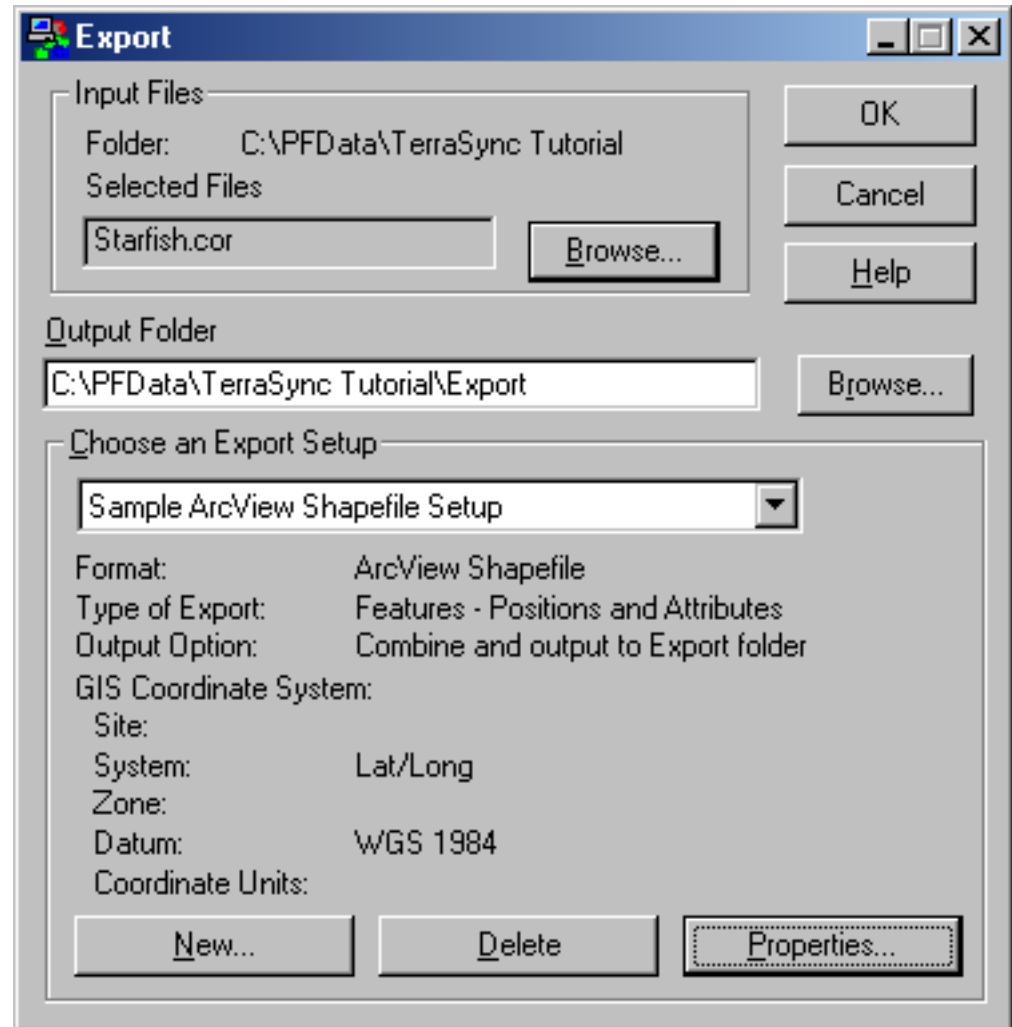

5. Make sure that the GIS Coordinate System group shows the Latitude/Longitude coordinate system. If the coordinate system is incorrect, click **Properties**, then select the Coordinate System tab in the Export Properties dialog to change the coordinate system. Click **OK** when you have finished.
6. Click **OK** to export the selected file(s) using the specified export setup.
7. The Export Completed dialog details the results of the export. Click **Close** to close this dialog.
8. The file is now in the format required by your GIS. You can now open it in your GIS.

NOTE — The Batch Processor utility increases productivity by letting you automate repetitive tasks that you do when you return to the office, such as data transfer, differential correction, and export to your GIS. When you come back from the field, simply connect the field computer to the office computer. The Connection Manager utility automatically recognizes that a field computer is connected and runs the Batch Processor utility.

For more information about these utilities, refer to the GPS Pathfinder Office Help.

Preparing for data update

NOTE — You cannot update imported data files using the **TerraSync Standard edition software**. If you have TerraSync Standard edition installed, you cannot perform the data update part of the tutorial.

A year has passed and it is necessary to return to Starfish Bay to check the condition of the road signs. A different field crew is going to do this. The TerraSync software and a real-time correction source will be used to navigate to each sign, and the Seaview data dictionary will be used to verify and update the attributes for those features. This part of the tutorial gives step-by-step instructions that should be followed before you go into the field to update data. The topics are:

- **Creating a data dictionary from existing data files**
- **Importing data from a GIS into GPS Pathfinder Office**
- **Transferring data to the field computer**

Creating a data dictionary from existing data files

NOTE — This step is only necessary for the tutorial. Normally, before collecting any data, you would create a data dictionary on a desktop computer, and then use the Trimble Data Transfer utility to copy the data dictionary to the field computer. Alternatively, you would create a data dictionary in TerraSync.

Before you can import data from a GIS, you need to recreate the Seaview data dictionary on the desktop computer.

Each SSF file contains a copy of its associated data dictionary. You will use the Starfish data file to recreate the Seaview data dictionary that is on the field computer.

To create a data dictionary from a data file:

1. Start the GPS Pathfinder Office software and open the TerraSync Tutorial project.
2. Start the Data Dictionary Editor utility. In the GPS Pathfinder Office software, select Utilities /Data Dictionary Editor. The main Data Dictionary Editor window appears.
3. Select File / Import From Data File. The Import From Data File dialog appears.
4. Highlight the Starfish.ssf file and click **Open**.

The Import From Data File dialog closes and you are returned to the main Data Dictionary Editor window where a new, unsaved data dictionary has been created.

5. Select File / Save. The Save As dialog appears. The default filename for the new data dictionary is Seaview.ddf.
6. Change to the C:\Pfddata directory and click **Save**.
7. In the Data Dictionary Editor window, select File / Exit.

Importing data from a GIS into GPS Pathfinder Office

Before going into the field, transfer the required information from the GIS to the TerraSync software. The Import utility in the GPS Pathfinder Office software converts data from a GIS data format into the **SSF** format required by the TerraSync software. The Trimble Data Transfer utility in the GPS Pathfinder Office software lets you efficiently transfer data between the office computer and the field computer. This part of the tutorial outlines how to transfer GIS data to a field computer that is running the TerraSync software.

To import GIS data into SSF format:

1. Start the GPS Pathfinder Office software and open the TerraSync Tutorial project.
2. Start the Import utility. In the GPS Pathfinder Office software, select Utilities / Import.

The Import Utility dialog appears.

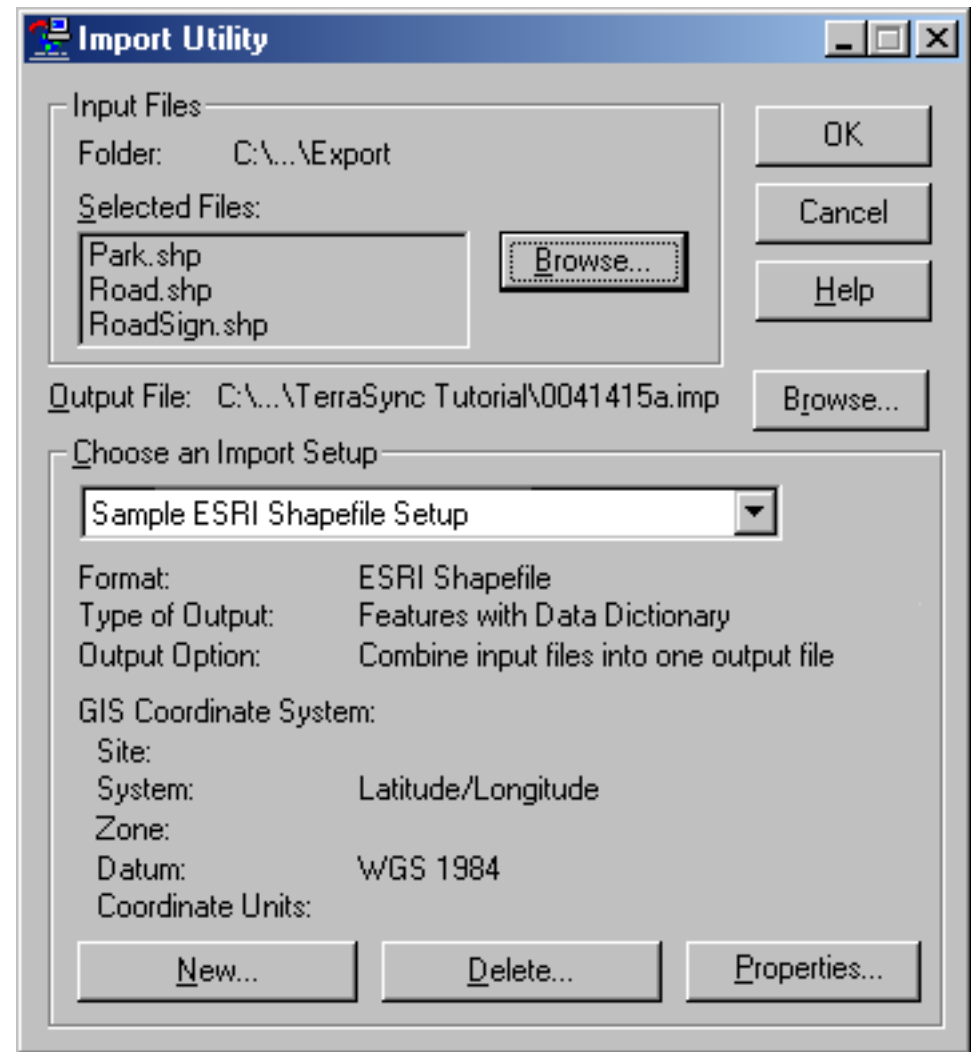

3. The three Shapefiles that you exported at the end of the data collection part of the tutorial appear in the Selected Files list. If they do not appear, click **Browse** and locate the folder C:\PfdData\TerraSync Tutorial\Export. Select the input files RoadSign.shp, Road.shp, and Park.shp, and then click **Open**.
4. In the Choose an Import Setup group, make sure that Sample ESRI Shapefile Setup is selected.
5. Change the import setup properties:
 - a. Click **Properties**. The Import Setup Properties dialog appears.
 - b. Make sure that the Data tab is selected.
 - c. In the Type of Data to Import group, select the Features with External Data Dictionary option.
 - d. Click **Dictionary File**. Browse for the Seaview.ddf file, highlight it, and click **Open**.
 - e. Select the Coordinate System tab and click **Change** to change to the coordinate system the GIS data uses. You must import GIS data using the same coordinate system that the GIS data is already stored in.

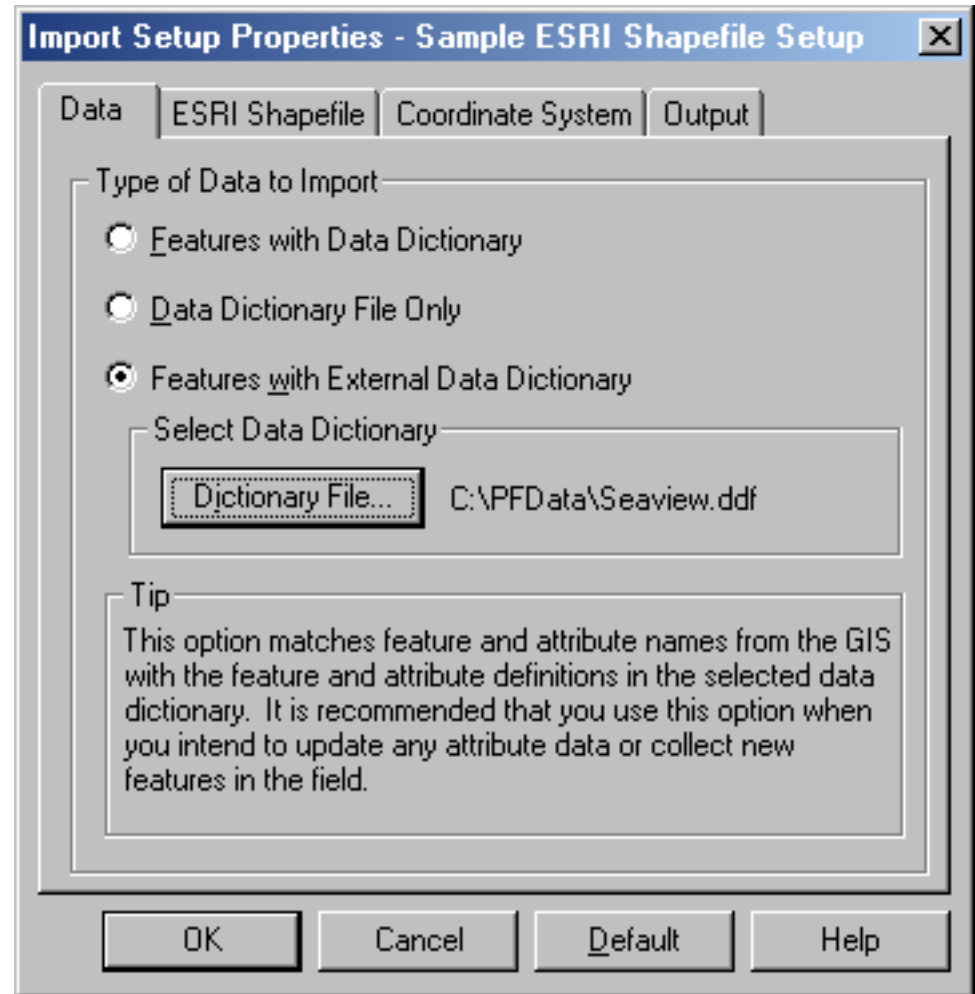

- f. Make sure that Latitude/Longitude is selected in the System field, and that WGS 1984 is selected in the Datum field.
 - g. Click **OK** to return to the Import Setup Properties dialog.
 - h. Select the Output tab.
 - i. In the Output group, make sure that the Combine input files into one output file option is selected.
 - j. Click **OK** to return to the Import dialog.
6. Click the **Browse** button beside the Output File field. The Specify Output File dialog appears. The default filename is in the format YMMDDHHR.imp.

NOTE — A .imp file is a file in **SSF** format that was created by importing from a GIS, CAD, or spatial database. It is the same as an .ssf file, but has a different filename extension to distinguish it from data files created in the field.

7. In the File Name field, enter **Starfish.imp** and click **Save**.
8. Click **OK** to import the file.
9. A message appears, showing information about the import. Click **Close** to close the message box.

For more information, refer to the GPS Pathfinder Office Help.

The file Starfish.imp is created from the selected Shapefiles. The next step is to transfer this file to the field computer.

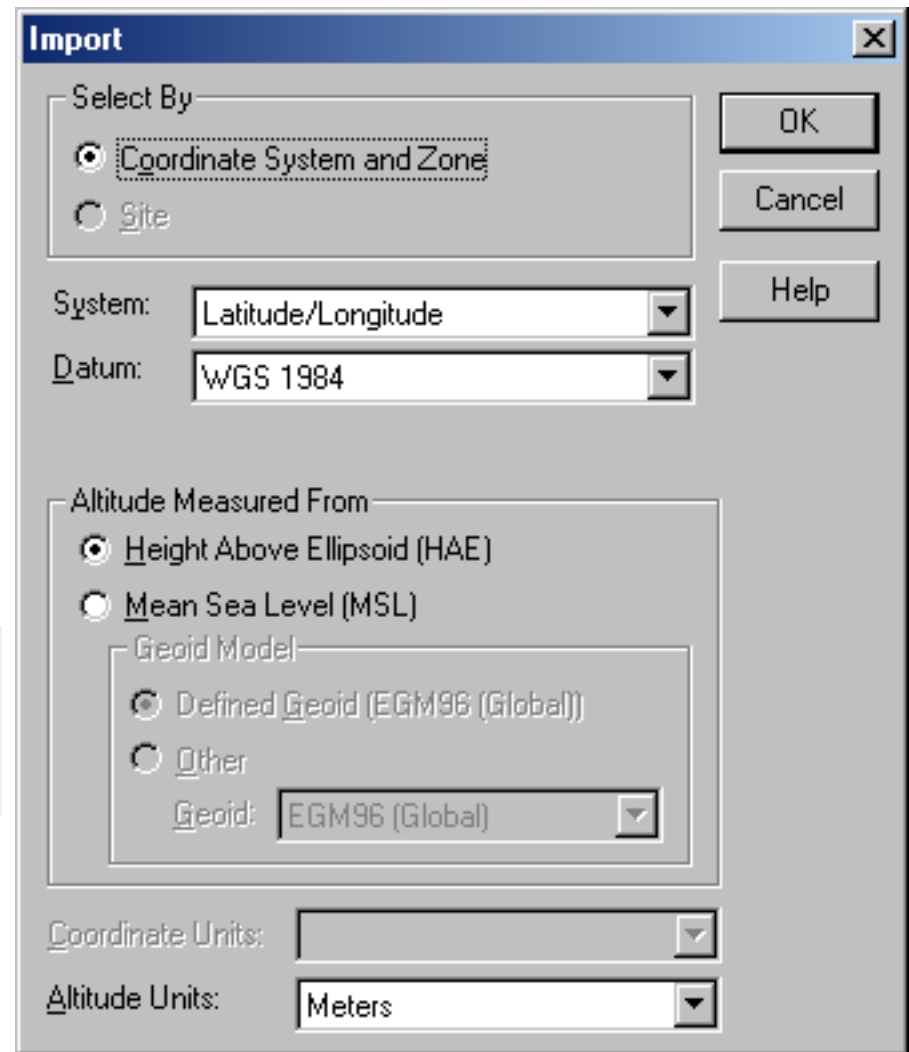

Transferring data to the field computer

You need to transfer the imported Starfish data file to the field computer, so that you can use it in the field to update existing data. Use the Trimble Data Transfer utility in the GPS Pathfinder Office software to efficiently transfer data between the office computer and a field computer running the TerraSync software.

To transfer files from the office computer to the field computer:

1. Switch on the field computer and the office computer and connect the two computers.
 - If the field computer is a CE device, the ActiveSync software should automatically establish a connection with the CE device. When ActiveSync is connected to a CE device, the message **Connected** appears in the main ActiveSync window, and its taskbar icon is green.
If ActiveSync does not connect automatically, connect to the CE device manually. For information, refer to the ActiveSync help, or see [Troubleshooting](#).
 - If the field computer is a PC, make sure that there is a network connection between the PC and the office computer.
 - If the TerraSync software and the GPS Pathfinder Office software are installed on the same computer, you only need to turn on the computer.
2. In the GPS Pathfinder Office software, select Utilities / Data Transfer.
The Data Transfer dialog appears.
3. From the Device list, select the appropriate device (GIS Datalogger on Windows CE or GIS Datalogger on Windows PC). Alternatively, if you have set up a device definition for the field computer, select that device name from the list. The Data Transfer utility automatically connects to the field computer.
4. Select the Send tab.
5. Click **Add** and select Data File from the drop-down list. The Open dialog appears.
6. The Starfish.imp file appears in the list of files. Highlight it and click **Open**.

The Open dialog disappears, and the Starfish data file appears in the Files to Send list.

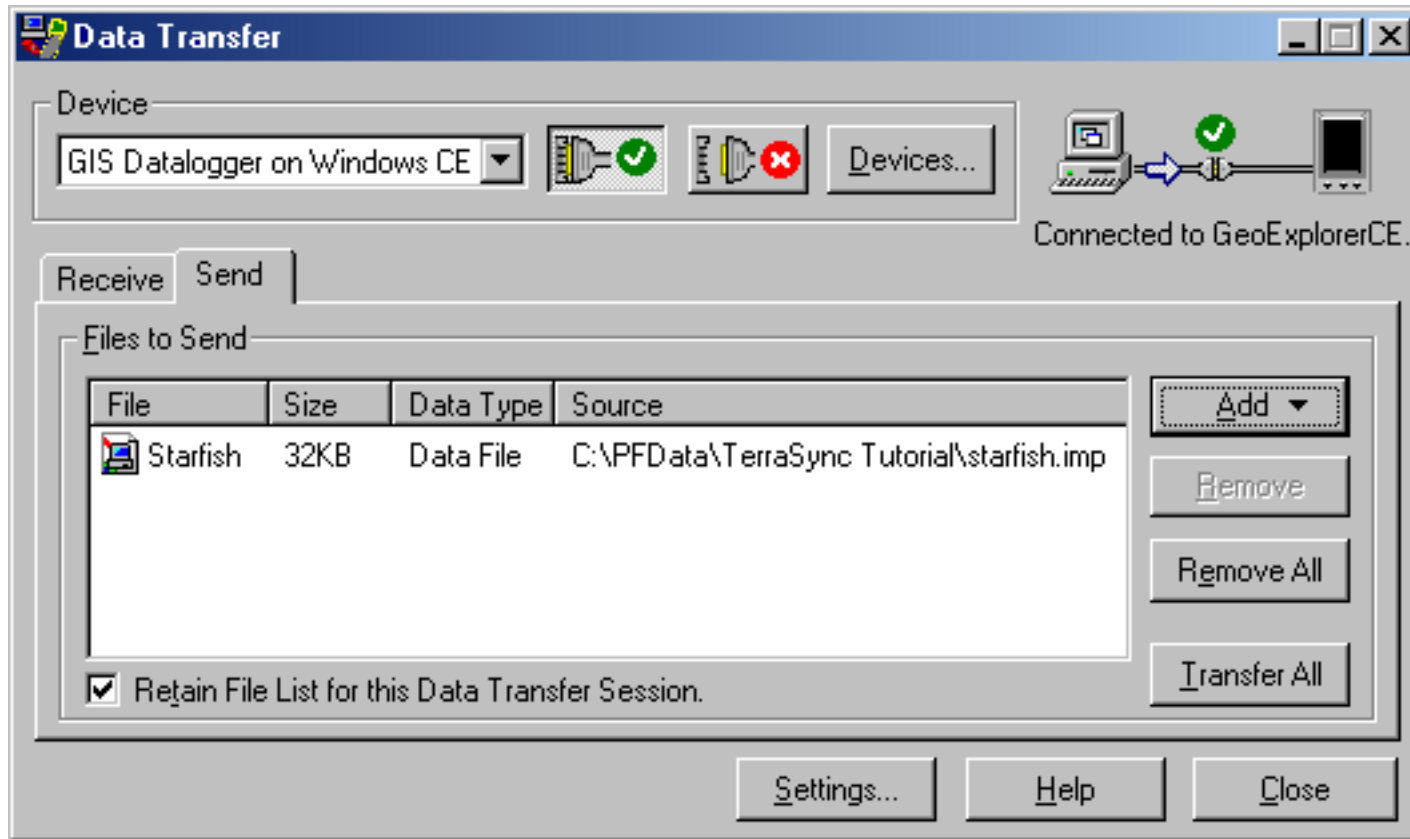

7. Click **Transfer All**. The data file is transferred to the CE device.
 8. A message showing summary information about the transfer appears. Click **Close** to close the message box.
 9. To close the Data Transfer utility, click **Close**.
 10. To close the GPS Pathfinder Office software, select File / Exit in the main GPS Pathfinder Office window.
- For more information, refer to the GPS Pathfinder Office Help.

Data update

NOTE — You cannot update imported data files using the **TerraSync Standard edition software**. If you have TerraSync Standard edition installed, you cannot perform the data update part of the tutorial.

This part of the tutorial uses the data file that you have just transferred to the field computer. You are ready to go to Starfish Bay and update features. This section gives the step-by-step instructions required to navigate back to features, and to update features. The topics are:

- **Using real-time differential GPS**
- **Updating data**

Using real-time differential GPS

You can use real-time differential GPS to navigate accurately to existing features. Use the [Navigation section](#) or the [Map section](#) to navigate back to a selected feature.

Topics in this section are:

- [Sources of real-time differential corrections](#)
- [Logging postprocessable positions](#)
- [Checking the real-time status](#)

Sources of real-time differential corrections

You can get real-time corrections from any of the following sources:

- Integrated beacon receiver
- Integrated satellite receiver
- Integrated WAAS/EGNOS receiver
- Integrated RTK radio
- External source, such as a Beacon-on-a-Belt (BoB) receiver

You can specify up to four choices for real-time corrections. If your first choice is not available, the TerraSync software automatically uses the second choice until the first choice is available again. This occurs at all levels, so the TerraSync software uses your preferred correction source at all times.

If you cannot use real-time corrections, or do not want to use them, set the first choice to Use Uncorrected GPS. No corrections will be applied to your data.

Use the **Setup section** to configure the real-time correction sources you want to use.

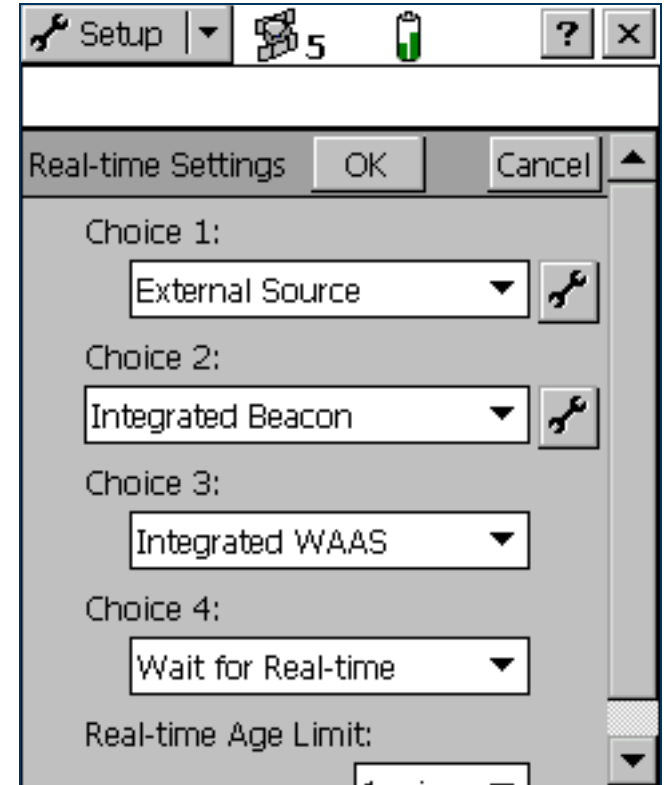

Logging postprocessable positions

When you use a real-time differential correction source, there may be times when you cannot receive corrections. Any positions logged during these times are uncorrected, and are subject to errors which degrade their accuracy.

If you log SuperCorrect GPS positions, you can receive real-time corrections, but you can also postprocess your data in the GPS Pathfinder Office software to improve the accuracy of the real-time corrected positions.

To log SuperCorrect data:

1. Tap the Section list button and select Setup.
2. Tap **Logging Settings**. The **Logging Settings form** appears.
3. In the Log SuperCorrect Data field, select Yes.
4. Tap **OK** to close the form.

NOTE — Logging SuperCorrect data takes up more storage space.

NOTE — You cannot postprocess RTK data collected using a 5700 or 5800 receiver.

Setup | 5 >><< ? X

Logging Settings OK Cancel

Log Velocity Data: No

Log SuperCorrect Data: Yes

Log QA/QC Data: No

Antenna Height: 2.000 m

Allow Position Update: Confirm

Confirm End Feature: No

Checking the real-time status

Always check the real-time status before navigating back to existing features.

TIP — Use the **Status bar** to quickly check the real-time status. When the TerraSync software is receiving real-time corrections, a real-time icon appears in the status bar. The icon flashes if there is a problem with the real-time source.

Use the **Status section** to view detailed information about the real-time status. Tap the Section list button and select Status. Then tap the Subsection list button and select Real-time. The Real-time Summary screen appears.

Use this screen to check that the TerraSync software is receiving corrections. When the TerraSync software is receiving corrections, a real-time icon appears beside the source in use. This icon indicates the type of correction source.

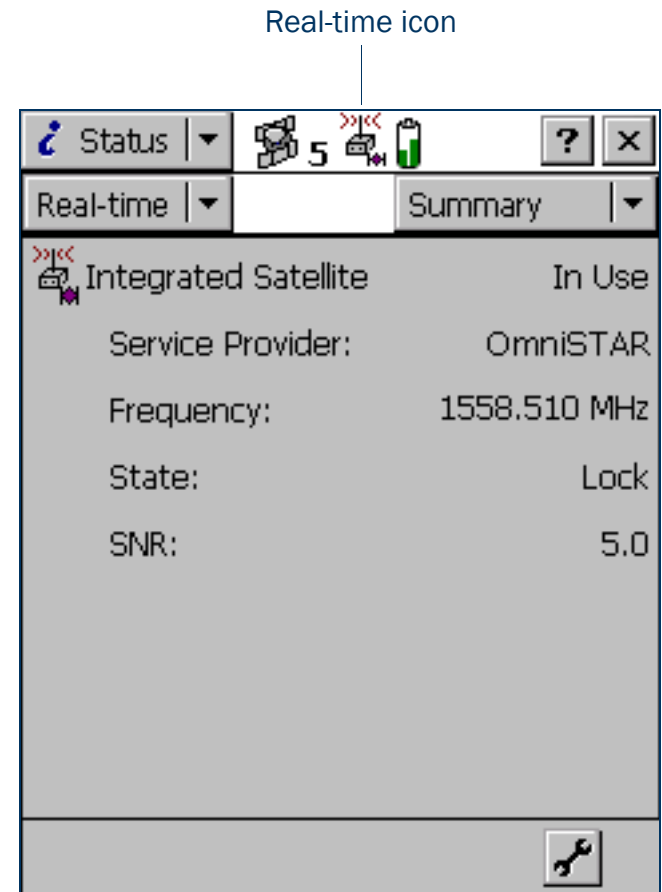

Updating data

Your supervisor has sent you to Starfish Bay to update information on existing signs.

As you did not record the original road signs you do not know exactly where they are. Use the TerraSync software and a real-time source (if it is available) to navigate to them.

This part of the tutorial gives step-by-step instructions for the following tasks:

- **Opening an existing data file**
- **Filtering features**
- **Selecting a target in the Data section**
- **Navigating to a target in the Navigation section**
- **Updating a feature**
- **Selecting a target in the Map section**
- **Navigating to a target in the Map section**
- **Marking a feature as updated**
- **Closing the file**

Opening an existing data file

Before starting the data update session, open the file that contains the GIS data. Use the **Data section** to do this.

To open an existing file:

1. Tap the Section list button and select Data.
2. Tap the Subsection list button and select Existing File.
3. Highlight the Starfish file. This is the file you imported earlier from the Seaview Authority GIS.
4. Tap **Open**.

The Update Features screen appears. This screen shows a list of all existing features in the data file.

You have opened a data file, so you can now start updating features.

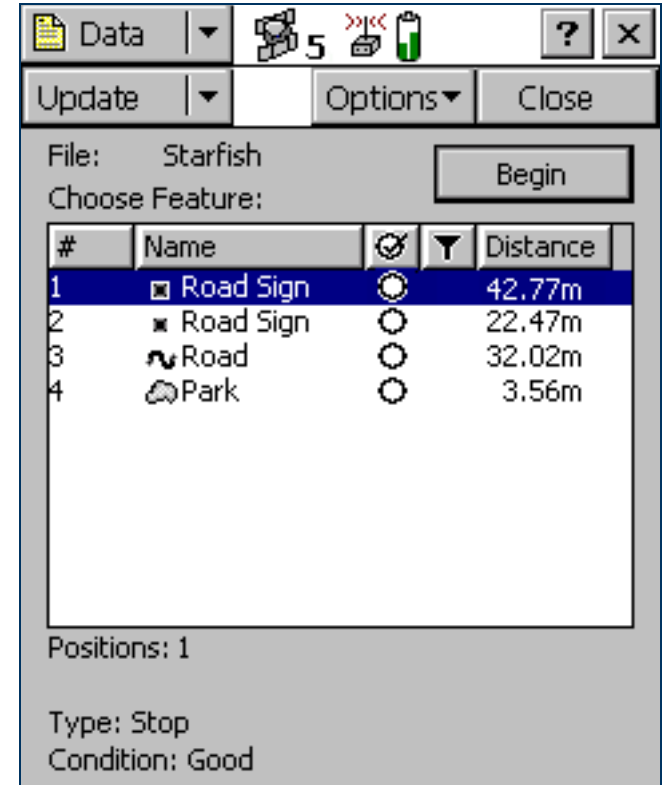

Filtering features

Your first data update task is to locate any road signs that need to be replaced by your field crew.

To make it easy to see which signs you need to visit, you will use filtering to group the features, then select the features you want to update from the filtered group.

You can filter features by their:

- update status
- deletion status
- feature type
- attribute values

The road signs you want to filter have the value Replace in the Condition attribute. To show only these signs, you need to filter by attribute value on the feature type Road Sign.

To filter features:

1. In the Data section, open the Update Features screen. Tap the Subsection list button and choose Update Features.
2. Tap **Options** and select Filter. The Filter By form appears.
3. Make sure that the Features check box is selected.
4. In the Road Sign field, select Filter By. The Attribute, Test, and Value fields appear below the Road Sign field.

The screenshot shows the 'Filter By' dialog box. At the top, there is a title bar with a 'Data' dropdown, an 'Update' dropdown, and several icons (a list icon, a '5', a signal strength icon, and a battery icon). Below the title bar are 'Filter By', 'OK', and 'Cancel' buttons. The main area contains several settings: 'Update Status' with an unchecked checkbox, 'Deleted Status' with an unchecked checkbox, and 'Features' with a checked checkbox. Below these are four rows of settings, each with a label and a dropdown menu: 'Road Sign' with 'Filter By...', 'Attribute' with 'Condition', 'Test' with 'Equal To', and 'Value' with 'Replace'. At the bottom, there are two rows of feature types with their respective filter settings: 'Road' with 'Unfiltered' and 'Park' with 'Unfiltered'.

5. In the Attribute field, select Condition.
6. In the Test field, make sure that Equal To is selected.
7. In the Value field, select Replace.
8. Tap **OK**. The Filter By form closes and you are returned to the Update Features form.

If a feature in the Choose Feature list meets the conditions you specified, the filter icon (🟢) appears in the Filter column for that feature. There should only be one road sign that meets the filtering conditions.

Selecting a target in the Data section

Now that you have filtered the list of features, you can visit each feature displayed and update its attributes. Use the [Navigation section](#) to locate an existing feature.

To navigate to a feature, select it as your target. Do this using the list of existing features.

To select a target:

1. In the Update Features screen, highlight the filtered road sign.
2. Tap **Options**.
3. Select Set Nav Target. The target icon 🎯 appears beside the selected feature. This icon replaces the point icon.

Navigating to a target in the Navigation section

To open the Navigation section, tap the Section list button and select Navigation. The Direction Dial screen appears.

Use the information displayed on the Direction Dial screen to navigate to the selected target.

This screen displays all the information that you need to navigate to the target. The **Information fields** at the bottom of the screen display different types of navigational information.

To navigate to the selected target, start moving. This enables the TerraSync software to calculate your initial heading. When the direction dial shows the turn arrow, keep moving and turning until the arrow points to the top of the screen.

The top of the screen indicates your current heading. Then move towards the target, adjusting your direction to ensure you are always heading towards the target.

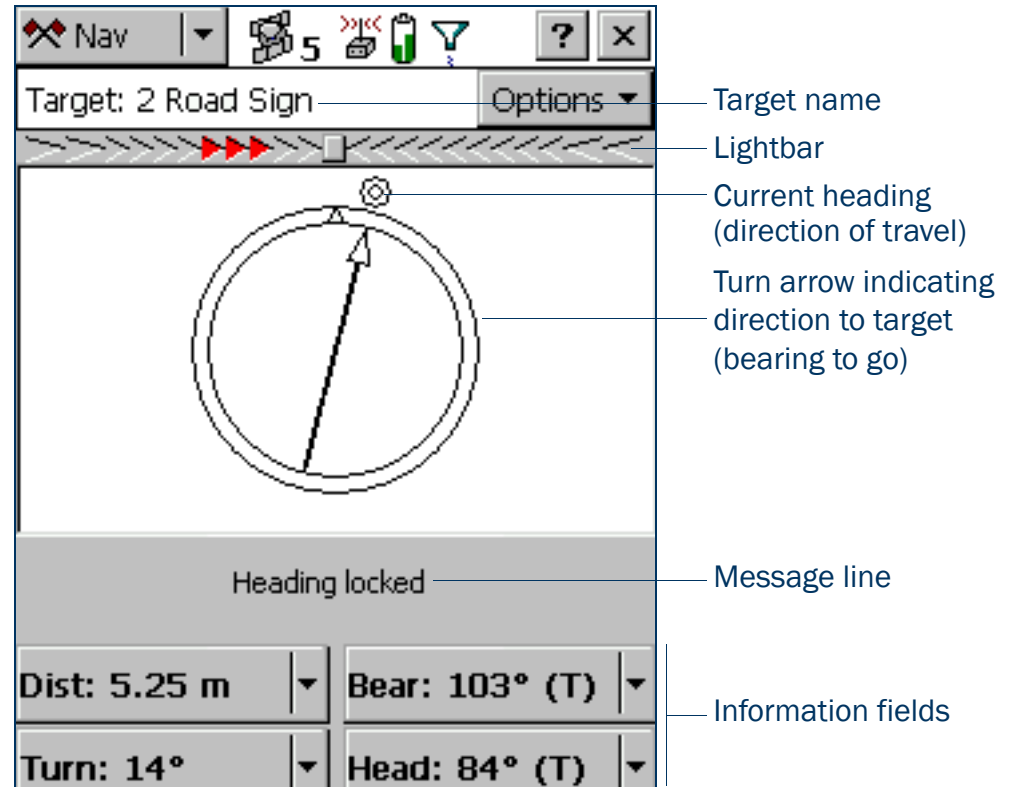

NOTE — If you are moving very slowly, or are stationary, the direction dial is not updated. The message **Heading Locked** appears.

When you are within a few meters of the target, the view switches to the Close-up screen. In the Close-up screen, your position is indicated by the cross **X** and the target is represented by the bull's-eye .

As you move closer to the target, the position symbol gets closer to the target symbol. You have reached the target when the position symbol is over the top of the target symbol.

TIP – In the Close-up screen, your heading is not updated. It is best to face in the same direction and move sideways, backwards, or forwards, rather than turn.



Updating a feature

You have opened the existing file and navigated to the road sign feature. Now you can edit the attributes.

To update the attributes for a feature:

1. Tap the Section list button and select Data, then tap the Subsection list button and select Update Features.

The Update Features screen appears.

2. The road sign you navigated to should be the highlighted feature in the list. If it is not, select it.
3. Tap **Begin** to display the attribute entry form for this feature. Use this form to update the attributes for the sign.

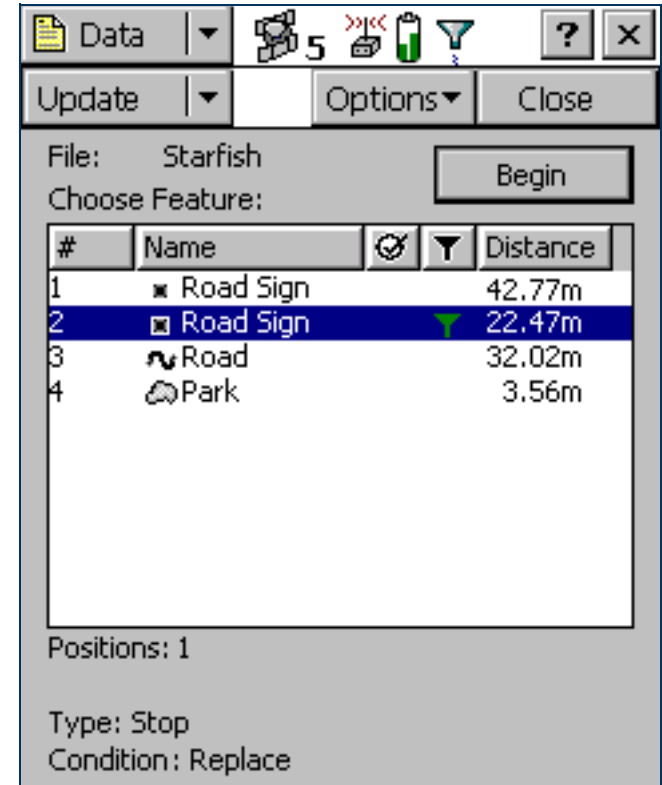

The Date Visited attribute has been set up to auto-generate on update. As soon as you make any change to the feature's attributes or position, this attribute is automatically updated with today's date.

4. The next attribute is the sign type. Use the Type attribute to verify that you are updating the correct sign. Check that the real sign matches the type recorded in the TerraSync software.
5. You and your field crew have replaced the damaged sign, so in the Condition field change the selected option from Replace to Good.
6. Tap **OK** to save the attribute changes and return to the Update Features screen.

For more information, see [Attribute entry form](#).

TIP – In the Update Features screen, the Updated column of the **Choose Feature list** shows the update status of each feature. Any feature that has been transferred from the GPS Pathfinder Office software has an empty circle (○) in this column. When a transferred feature is updated, a check mark (☑) appears in the circle.

The screenshot shows the 'Update' dialog box in TerraSync software. At the top, there is a 'Data' dropdown menu and a toolbar with icons for settings, a signal strength indicator (5), a battery level indicator, and a filter icon. Below the toolbar, there are 'Update', 'Options', and 'Log' buttons. The main content area shows the feature name '2 Road Sign' with 'OK' and 'Cancel' buttons. Below this, there are three fields: 'Mark as updated:' with an unchecked checkbox, 'Date Visited:' with a date picker set to '6/17/03', and 'Type:' with a dropdown menu set to 'Speed Limit'. The 'Condition:' field has a dropdown menu set to 'Good'.

Selecting a target in the Map section

Finally, you need to revisit the Road feature called Seagull Street. You will use the Map section to navigate to the beginning of Seagull Street.

To select a target using the Map section:

1. Tap the Section list button and select Map.
2. If necessary, zoom in or out until all the features in the data file are visible.
3. The Seagull Street feature is the only line feature on the map. Tap any part of the line feature to select it.

A selected line feature has a wider line than an unselected line feature.

NOTE — Your Map screen may appear different from the one shown.

When you select a feature, a tooltip appears. The tooltip shows the feature's number, name, and position.

4. Tap **Options** and select Set Nav Target. The target icon  appears at the start point of the selected road.

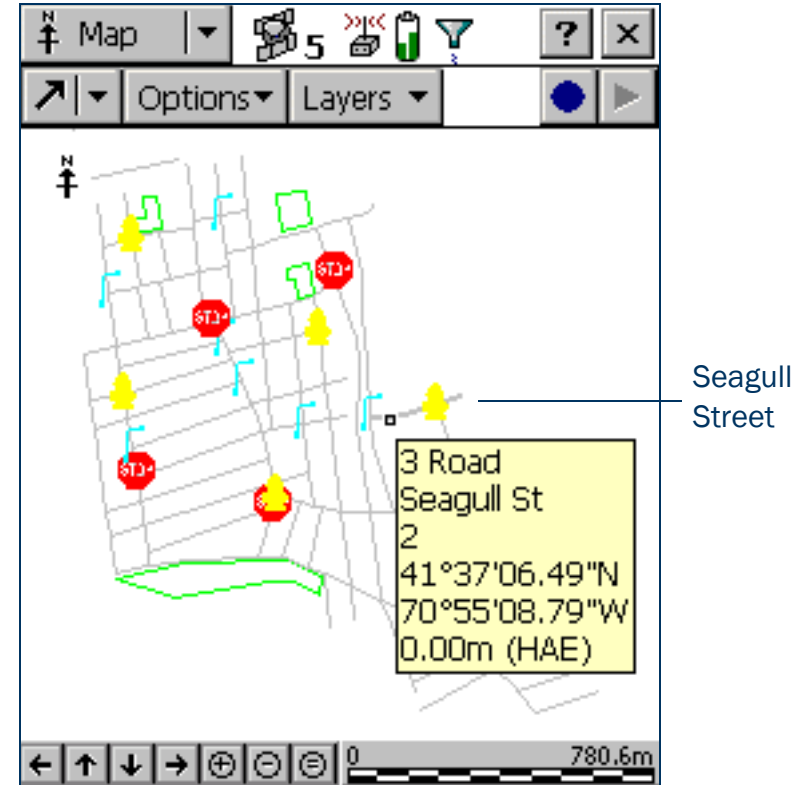

Navigating to a target in the Map section

Once you have selected a target from the map, you can use the map to guide you to this target. The GPS cursor  shows your current position and heading.

To navigate to the target, make sure that the heading arrow on the GPS cursor points towards the target as you move.

You may need to use **Zooming** or **Panning** to ensure that both the target and the GPS cursor are visible. When the target is not visible, the bearing arrow  at the edge of the map shows its direction.

NOTE — Your Map screen may appear different from the one shown.

When the GPS cursor lies over the target icon, you have successfully navigated to the target.

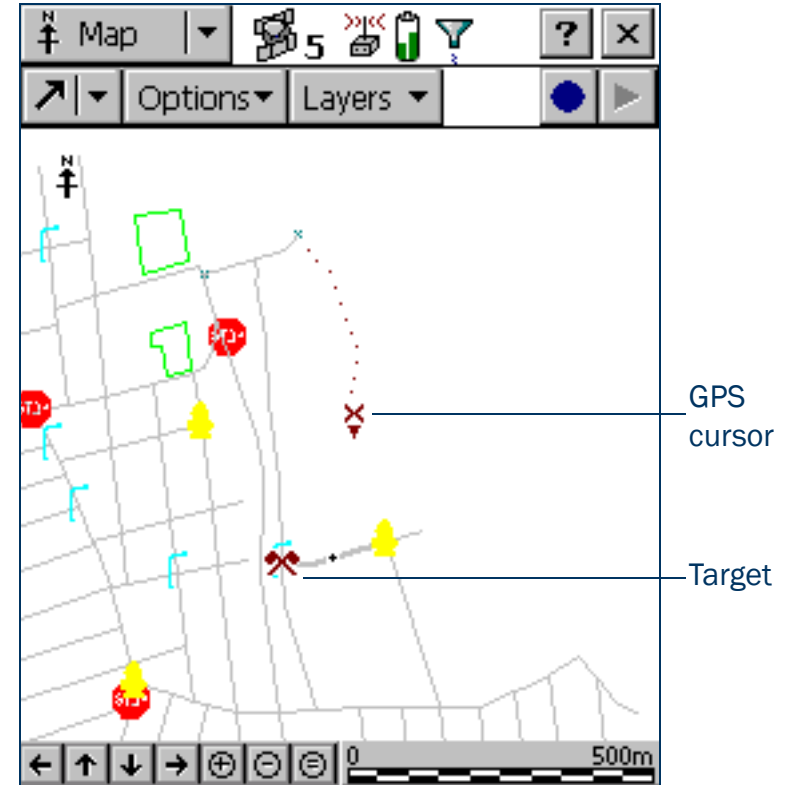

Marking a feature as updated

You have navigated to the road feature. Now you can check its attributes and change its status to Updated.

To mark a feature as updated:

1. Make sure that the Map section is active. If it is not, tap the Section list button and select Map.

The road you navigated to should be the highlighted feature.

2. Double-tap the road feature to display its attribute entry form.
3. All attribute values are correct, so you do not have to make any changes. Instead, select the Mark as updated check box.
4. Tap **OK**. The attribute entry form closes and you are returned to the Map section.

When you change an existing feature's attributes, offset, or GPS position, the feature's status automatically changes to Updated, and the Mark as updated check box is selected.

When you manually select the Mark as updated check box, the TerraSync software changes the feature status only. It does not change any attributes, offsets, or positions. Use the Mark as updated function to indicate the features that you have visited but have not changed.

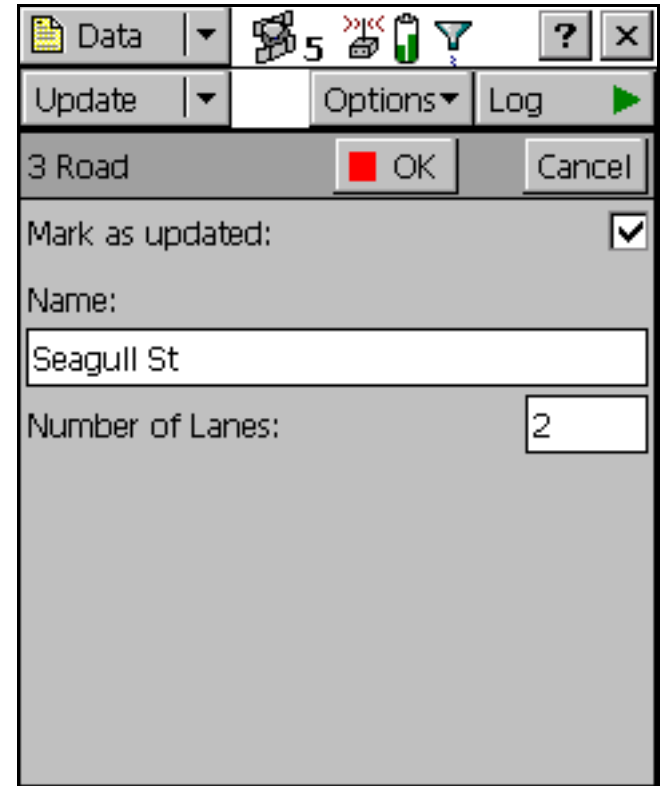

The screenshot displays the TerraSync software interface. At the top, there is a toolbar with icons for Data, a 3D map view, a battery level indicator, and a filter icon. Below the toolbar, there are buttons for 'Update', 'Options', and 'Log'. The main content area shows the attribute entry form for a road feature. The title bar indicates '3 Road' and includes 'OK' and 'Cancel' buttons. The form contains a 'Mark as updated:' checkbox which is checked, a 'Name:' field with the text 'Seagull St', and a 'Number of Lanes:' field with the value '2'.

Closing the file

When the data update session is completed, exit the TerraSync software. You do not have to close the data file first. If you exit the software while a data file is still open, the TerraSync software closes the file before exiting.

To exit the TerraSync software:

1. Tap the Close button  in the upper right corner of the screen. A message appears, asking you to confirm that you want to close the file and exit the software.
2. Tap **Yes**.

ADVANCED FUNCTIONS

When using the TerraSync software to collect and update data, you can take advantage of a variety of advanced functions to provide more accurate and efficient results. The following topics are discussed here:

- [Advanced data collection](#)
- [Coordinate systems](#)

Advanced data collection

Advanced data collection methods offer time-saving techniques for efficient field work. Step-by-step instructions are provided for:

- **Advanced datalogging options**
- **Recording between feature positions**
- **Continuing line and area features**
- **Offsets**
- **Using an external sensor**
- **Repeating features**
- **Segmenting line features**
- **Recording averaged vertices**
- **Using corrections from a VRS**
- **High-accuracy data collection**
- **Setting up a base station**

Advanced datalogging options

The TerraSync software provides two closely-related options for logging GPS data. These options differ in their timing of GPS data collection relative to the start of a feature. The options are:

- Log Now – start a feature and simultaneously start collecting GPS positions.
- Log Later – start a feature, and start collecting GPS positions later.

If you select the *Log Now* option, TerraSync begins logging positions for a new feature as soon as you select the feature type and tap **Create**. You can enter attribute values while positions are being recorded.

Log Now is the default logging option. When Log Now is selected, a bullet (•) appears beside it in the option list. To select Log Now, tap **Options** in the **Collect Features screen**. Then select Log Now from the option list.

NOTE — Log Now applies only to new features. When you open an existing feature for update, logging is paused and the pause icon flashes in the **Status bar**. New positions are logged for an existing feature only after you tap **Log** in the attribute entry form and select the Update position option.

If you select the *Log Later* option, TerraSync only begins logging positions for a new feature after you tap **Log** in the attribute entry form. Until you begin logging, the pause icon flashes in the **Status bar**.

When Log Later is selected, a bullet (•) appears beside it in the option list.

To select Log Later, tap **Options** in the **Collect Features screen**. Then select Log Later from the option list.

Recording between feature positions

The GPS data that you collect with the TerraSync software is recorded in files. You can collect positions in a file without collecting feature and attribute data. These positions are called *between feature positions*. They appear in their own layer on the Map graphical screen.

Recording GPS positions only is useful if you do not need to record feature and attribute data. For example, you may want to record a trail of the day's activities to track where you have been. In this case, you would not want to collect feature or attribute information, only the positions. You can also use between feature logging to record the route traveled from one feature to the next.

By default, the TerraSync software does not record between feature positions. Use the **Logging Settings form** in the Setup section to enable between feature logging. If the Interval field contains a time or distance value, then between feature logging is enabled. If the Interval field is set to Off, then between feature logging is disabled.

Between feature positions can be spaced by distance or time. For example, use the distance option to force the TerraSync software to log a position every three meters you travel; or use the time option to log a position every five seconds. To set the logging interval, select the logging style (Distance or Time) in the Style field, and then enter the rate in the Interval field.

If between feature logging is enabled, the TerraSync software logs positions (at the specified rate) whenever you are not logging positions to a feature.

Continuing line and area features

When recording a line or area feature, you could come across another feature that you need to record. The feature may be adjacent to the line/area feature, or it may be some distance away. When collecting a path (line feature), for example, you might encounter a gate (point feature). You do not have to record the entire path and then return to record the gate. Simply end the path feature, collect the gate feature, and then use the Continue option to resume collecting the path feature.

NOTE — Other Trimble GIS data collection products refer to this functionality as *nesting*.

You can continue any line or area feature, not just the last one collected, provided you have not used the Continue option for any other features since collecting that line or area feature.

Once you continue a feature, you cannot continue any line or area features collected between the two segments of that feature. These features they are now nested within the continued feature. Any features you collected before the continued feature are also unavailable for continuation.

New features that you collect after the continued segment will be available for continuation, because you have not continued any other feature since they were collected. If you replace an existing feature's positions with new GPS or digitized positions, the Continue option treats the feature as a new feature, so it can be continued.

NOTE — You can collect as many features within a line or area as you need. The number is limited only by storage space on the field computer.

To use Continue:

1. In the attribute entry form, tap **OK** to close the line or area feature you are collecting. The **Collect Features screen** appears.
2. In the Choose Feature list, highlight the feature that you want to collect and tap **Create**. The attribute entry form appears and logging starts.
3. When you have recorded attributes for the feature and logged sufficient GPS positions, tap **OK** to close the feature. The **Collect Features screen** appears again.
4. Tap **Options**. From the option list, select Continue. The **Continue feature form** appears, listing all the line and area features that are available for continuation, in the order they were collected.
5. Select a feature from the list and tap **Continue**. TerraSync returns to the attribute entry form for the selected line or area feature, and continues to log GPS positions for that feature.
6. When you complete the traverse of the line or area perimeter, tap **OK** to store the feature.

TIP — You can also continue a selected feature from the Update Features subsection, or from the Map section. Do one of the following:

- Highlight the feature in the Update Features screen, tap **Options**, and then select Continue.
- From the Update Features section or the Map, open the feature for update. Then begin logging GPS or digitized positions. A message box appears, asking you to specify the logging option you want. Select the Continue feature option and then tap **OK**.

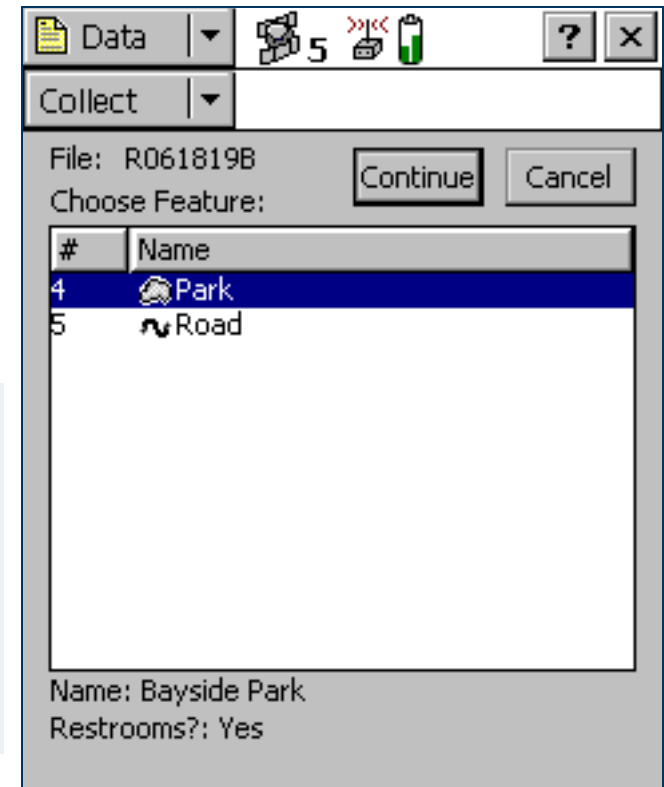

Offsets

If you cannot travel over the top of, or right next to, a feature, you can enter an offset and record it at the specified distance. When collecting a tree feature, for example, it may be easier to stand some distance (for example, 10 paces to the North) from the tree and record its attributes. This ensures good GPS reception, and lets you see the tree clearly to assess its condition. Specify an offset to the tree of 10 m South. This is an example of an *offset point feature*. Entering an accurate offset ensures that the feature is positioned correctly in the GIS.

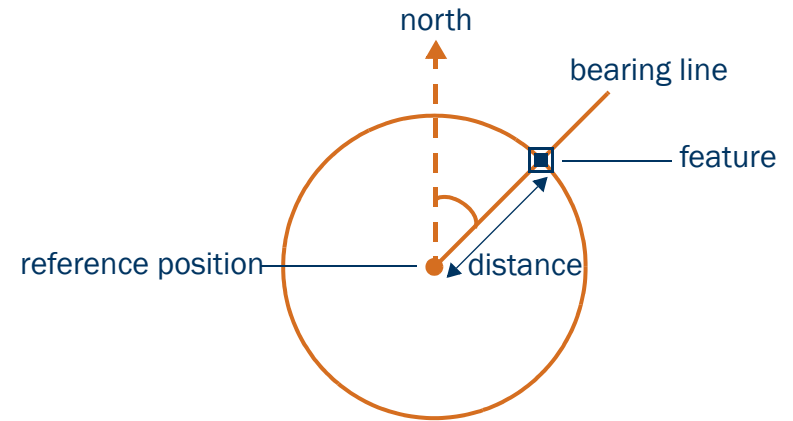

NOTE — The example above is a simple distance-bearing offset. For point features, you can also record *complex offsets*, which use measurements from two or more reference positions to calculate the feature position. For more information, see [Complex offsets](#).

To view or enter the offset for the feature being collected or updated, tap **Options** in the attribute entry form, then select Offset.

You can also use offsets for line and area features. For example, when collecting a line feature such as a fence, it may be easier to drive along the road beside the fence and record the positions of the fence as an offset. When collecting an area feature such as a lake, you could walk some distance from the lake edge and record its perimeter using an offset.

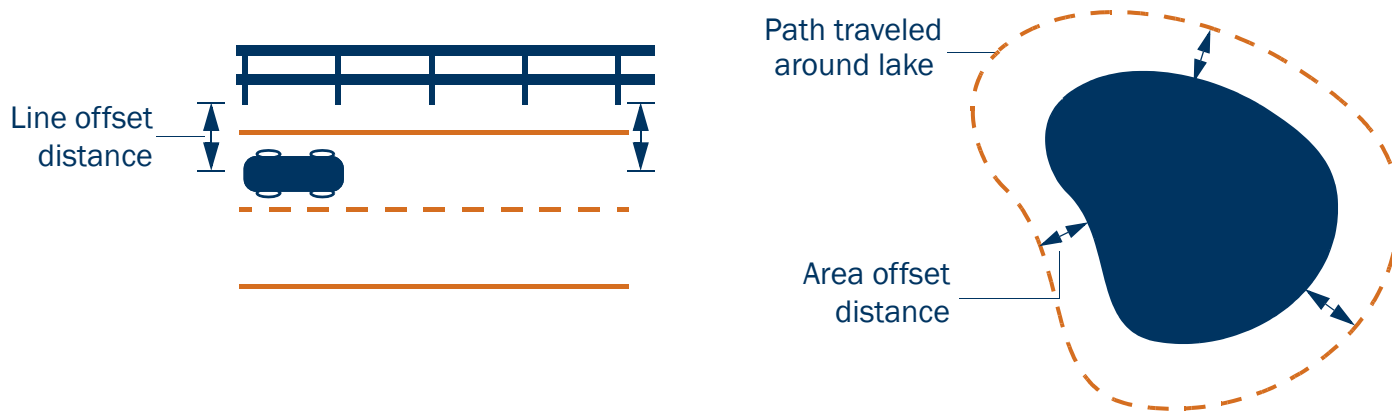

NOTE — Any feature (point, line, or area) can have only *one* offset associated with it. To collect a line or area feature using offsets, the same offset value must apply to the whole feature. This may require a test run around or along an object to make sure that you can remain a consistent distance from it.

NOTE — You can record a line feature as a series of joined line segments, each with a different offset. For more information, see [Segmenting line features](#).

Offsets are added to GPS and digitized positions as they are recorded, and features are displayed in the Map section with their offsets. However, if the currently open line or area feature has an offset, acute angles and corners can appear distorted on the map. This is because exact offset values are not calculated for these positions until the feature is closed. When you close a feature, offsets for these positions are interpolated, and the feature is redrawn more accurately.

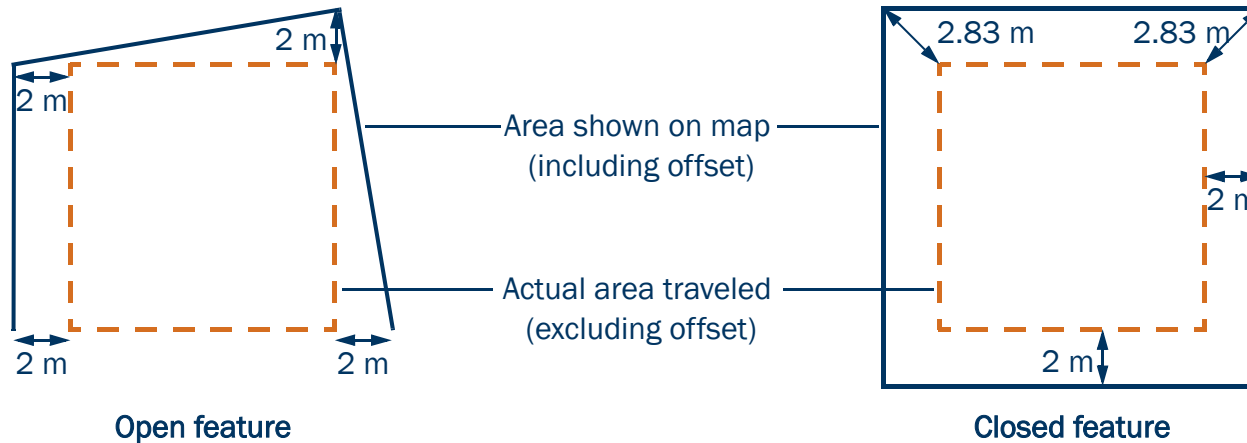

To record an offset for a feature:

1. Start the feature.
2. In the attribute entry form, tap **Options** and then select Offset.
3. If the current feature is a point feature, select the type of offset you want to record. Then tap **OK**.

The appropriate offset form appears. The fields on the offset form depend on the type of feature you are collecting (point, line, or area) and the type of offset you are collecting.

4. Enter a value in each field as necessary. Alternatively, use data from a laser rangefinder. For more information, see [Using a laser rangefinder to record offsets](#).
5. When the offset form is complete, tap **OK**. The attribute entry form reappears.
6. When you have recorded attributes for the feature and logged sufficient GPS positions, tap **OK** to store the feature. The **Collect Features screen** appears.

The screenshot shows the 'Offset for 3 Road' form. At the top, there is a 'Data' dropdown menu, a 'Collect' dropdown menu, and a 'Pause' button. Below this, the title 'Offset for 3 Road' is displayed, followed by 'OK' and 'Cancel' buttons. The form contains three input fields: 'Direction:' with a dropdown menu set to 'Left', 'Horizontal distance:' with a text box containing '0.00 m', and 'Vertical distance:' with a text box containing '0.00 m'.

NOTE — You can also record **Complex offsets** for point features.

Complex offsets

When you record a complex offset, you do not record any position information for the feature. Instead, you record GPS positions for two or three reference positions and measure the distance or direction from each reference position to the feature. Then TerraSync uses coordinate geometry (COGO) to calculate the location of the feature, in much the same way as a GPS receiver uses the distances to GPS satellites at known locations to calculate GPS positions.

In TerraSync, you can record a complex offset using either two or three reference positions, and you can specify either the distance to the feature, or the bearing (direction). You can record the following types of complex offset:

- **Distance-distance offset**
- **Triple distance offset**
- **Bearing-bearing offset**
- **Triple bearing offset**

To increase accuracy, you can record each reference position as if it were an averaged vertex. If you log a number of positions at each reference point, TerraSync averages these positions to give a more accurate reference position. The principle of **Dilution of Precision** applies to complex offsets, so you should choose reference positions that are widely spaced.

For detailed instructions, see **Recording a complex offset**.

Recording a complex offset

To record a complex point offset:

1. Start the point feature.
2. In the attribute entry form, tap **Options** and select Offset.
3. In the **Point offset type form**, select the type of offset you want to record, then tap **OK**. The appropriate offset form appears.
4. Follow the instructions at the top of the form. When you have completed each step, tap **Next** to move to the next step. For each reference position:
 - a. Move to the reference position.
 - b. Tap **Log** (or **Resume**) to begin logging.
 - c. Remain stationary at the reference position while you log positions.
 - d. When you have collected sufficient positions, tap **Next** to stop logging.
 - e. Measure the offset. This is the distance or the bearing from the reference position to the feature. You can use data from a laser rangefinder. For more information, see [Using a laser rangefinder to record offsets](#).
 - f. Tap **Next** to confirm the measurement for this reference position.

Bearing - Bearing offset for 6 Road Sign

Enter the bearing from reference position 2 to the feature.

Next Clear

Reference position 1 Collected

Bearing A

Bearing (T) 56.00°

Reference position 2 Collected

Bearing B

Bearing (T) 56.00°

5. If you are recording an offset that uses distances, enter the direction that the features lies in relative to the path between the reference positions.

The software calculates the feature's position.

6. When the offset form is complete, tap **OK**. The attribute entry form reappears.

NOTE — Logging is paused because you only have to record positions for the reference positions, not the feature itself.

7. Record attributes for the feature, and then tap **OK** to store the feature. The **Collect Features screen** appears.

Distance-distance offset

A distance-distance offset uses the distance between the feature and two reference positions (A and B) to specify the feature's position. The feature lies at the point where the circles centered on A and B intersect. Because there are two points where the circles intersect, you need to specify which direction the feature is in, relative to the path from A to B.

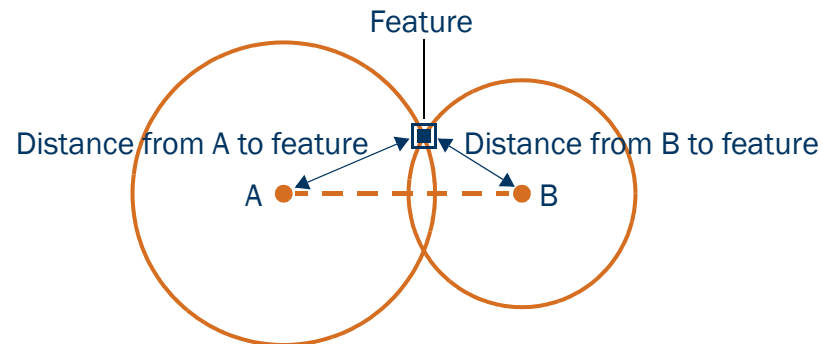

Triple distance offset

A triple distance offset uses the distance between the feature and three reference positions (A, B, and C) to specify the feature's position. The feature lies at the point where the circles centered on A, B, and C intersect. There can be only one point where the three circles intersect, so you usually do not need to specify a direction. A triple distance offset is similar to a distance-distance offset, but a third measurement provides some mathematical redundancy that can improve accuracy.

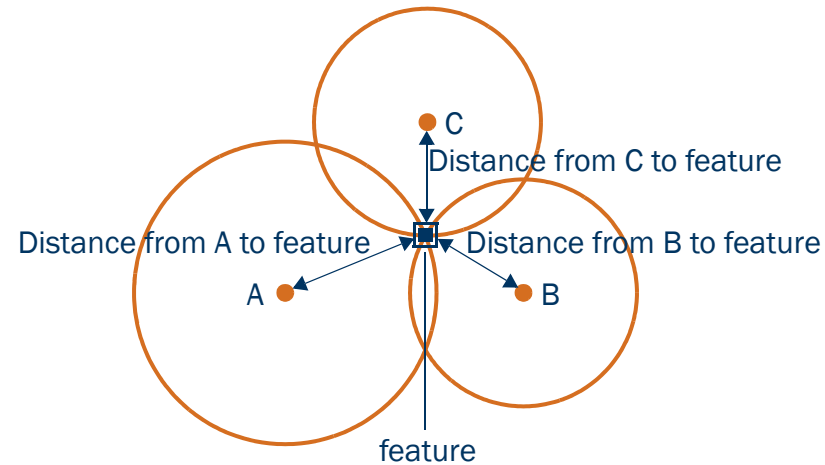

Bearing-bearing offset

A bearing-bearing offset uses the bearing from north from each of two reference points (A and B) to the feature to specify the feature's position. The feature lies at the point where the two bearing lines intersect.

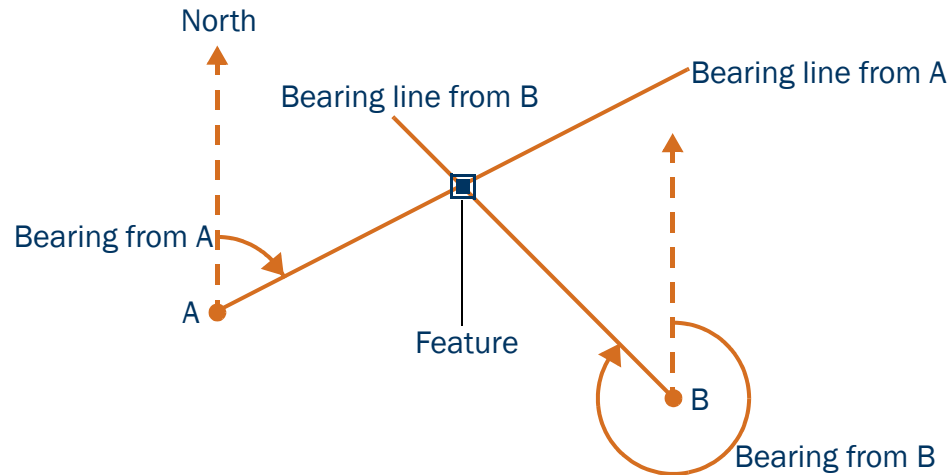

Triple bearing offset

A triple bearing offset uses the bearing from north from each of three reference points (A, B, and C) to the feature to specify the feature's position. The feature lies at the point where the three bearing lines intersect.

A triple bearing offset is similar to a bearing-bearing offset, but a third measurement provides some mathematical redundancy that can improve accuracy.

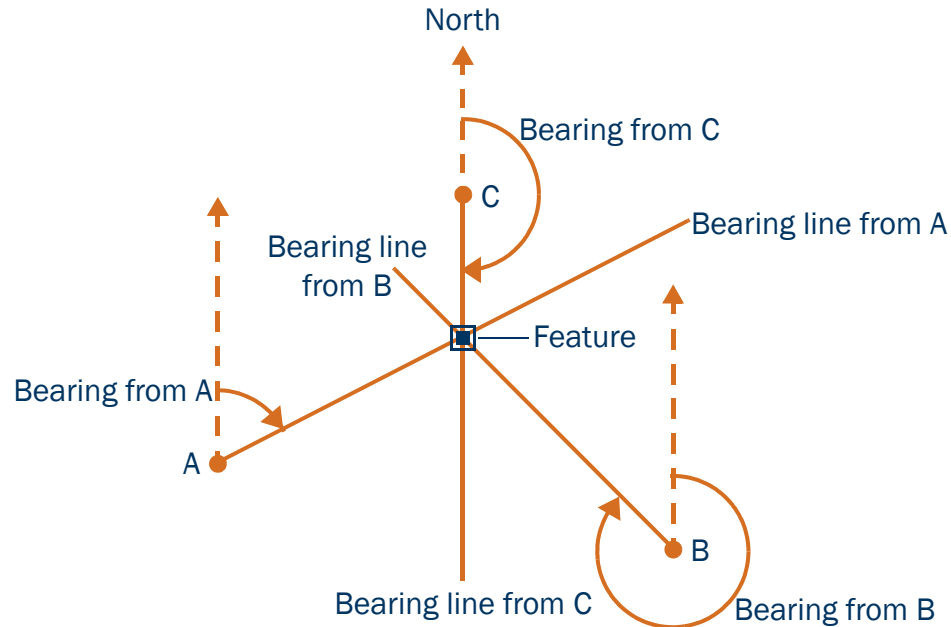

Using a laser rangefinder to record offsets

You can use a laser rangefinder to record accurate offsets for any feature. To use a rangefinder with the TerraSync software, you only need to specify which serial (COM) port on the field computer the rangefinder is connected to. For a list of the laser rangefinders that the TerraSync software supports, go to www.trimble.com/terrasync_specs.html.

To record an offset from a laser rangefinder, make sure that a feature is open, and that the feature's attribute entry form, the appropriate offset form, or the Map screen is open. Then fire the laser rangefinder. The TerraSync software stores the distance and, if the laser rangefinder supports it, the bearing, in the appropriate field(s) in the offset form.

Before storing an offset from a laser rangefinder, TerraSync subtracts the **Antenna Height** from the measurement. The antenna height is specified in the Setup section. An incorrect antenna height can reduce the vertical accuracy of the feature's position. If vertical accuracy is important, make sure that you do the following:

- Set the antenna height to the vertical distance from the laser rangefinder to the antenna, not to the distance from the ground to the antenna. You can use a configuration file to do this.
- Keep the laser rangefinder as close to the antenna phase center as possible when shooting.
- Shoot at a higher position on the feature to compensate for the antenna height being subtracted from the feature's altitude.

For more information on configuring a laser rangefinder to work with the TerraSync software, see **External Sensors**.

You can also use a laser rangefinder as an external sensor. For more information, see **Using an external sensor**.

Using an external sensor

You can use an external sensor with the TerraSync software. The data recorded by the sensor can be stored as an attribute, or it can be stored in the data file as an uninterpreted sensor data record. You can export uninterpreted sensor data from the GPS Pathfinder Office software to the GIS or processing software.

Depending on the way you want to store the sensor data, and the capabilities of the sensor, you can configure TerraSync to read data from the sensor at specified intervals, or only when you request it.

For more information on configuring an external sensor to work with the TerraSync software, see [External Sensors](#).

NOTE — A laser rangefinder can be used either as an external sensor, as described here, or to supply data for feature offsets. For more information, see [Using a laser rangefinder to record offsets](#).

Repeating features

Use Repeat to efficiently record a sequence of similar features. When you use Repeat, attribute values are copied from the last recorded feature of the same type. You do not have to re-enter values for all attributes. Just check that each attribute value is correct for the new feature, and change only those that are different.

To repeat attributes for similar features:

1. In the **Collect Features screen**, tap **Options** and select Repeat. When Repeat is selected a check mark (✓) appears beside it in the option list.
2. Select a feature from the Choose Feature list and tap **Create**. The attribute entry form appears. The attribute values that appear are those of the last recorded feature of that type. Edit them if necessary. Tap **OK** to save the attribute values and store the feature.
3. Select another feature. Continue until you want to turn off Repeat mode.

To turn off Repeat mode:

- In the **Collect Features screen**, tap **Options** and select Repeat. The check mark disappears.

NOTE — When Repeat is not selected, the data dictionary determines default attribute values. Where appropriate, the data dictionary specifies a default value for each attribute of a feature.

Segmenting line features

Use segmenting to record a line as several segments that are joined together, each with different attribute values. For example, you can record a road feature that has one surface for part of its length, and a different surface for the rest of its length.

When you segment a line feature, the TerraSync software immediately records a position, even if the logging interval does not require a position at that time. This position becomes the last position in the old line and the first position in the new line. Recording a position at the segmentation point ensures that the two line segments join up in the GPS Pathfinder Office software and the GIS.

The offset of the new line segment defaults to the offset of the previous line segment, if there is one. The new line feature has the same attribute values as the previous line segment, except that any auto-incrementing attributes are incremented to the next value.

NOTE — If the line feature has an offset, the two line segments may not “snap” together.

To segment a line feature:

1. While logging a line feature, in the **Attribute entry form** tap **Options** and select Segment Line. The TerraSync software ends the current line feature and immediately starts another line feature of the same type.
2. If necessary, edit the new feature’s attributes.

CAUTION — If you are logging an averaged vertex when you segment a line feature, the first position of the new segment is located at the last GPS position, not at the calculated position of the last averaged vertex. This can cause a gap between the segments. To ensure that the two segments join, record a single, unaveraged GPS position as the last position in the first segment. Then segment the feature, and start recording averaged vertices for the new segment if required.

CAUTION — If logging has been paused for more than five seconds before you segment the line, the two line segments may not “snap” together.

Recording averaged vertices

A line or area feature consists of a number of positions, joined in sequence from the first position logged to the last. Each position represents a **vertex** of the feature. For more accurate recording of line and area features, you can record several positions at each vertex, then average these positions to calculate the vertex position.

Logging a line or area feature with averaged vertices is similar to logging a number of averaged point features, and then joining these point features together in sequence.

To record an averaged vertex for a line or area feature:

1. In the **Attribute entry form** for the line or area feature, tap **Options** and select New Vertex.

The Vertex form appears. This form contains the same fields as the attribute entry form.

Logging of positions for the averaged vertex begins immediately. The logging icon in the status bar changes to an animated circle zooming in . The number beside it shows the number of positions logged for this vertex.

2. If necessary, enter or edit attribute values for the feature.
3. When you have logged as many positions as you require for this vertex, close the Vertex form. You are returned to the attribute entry form.

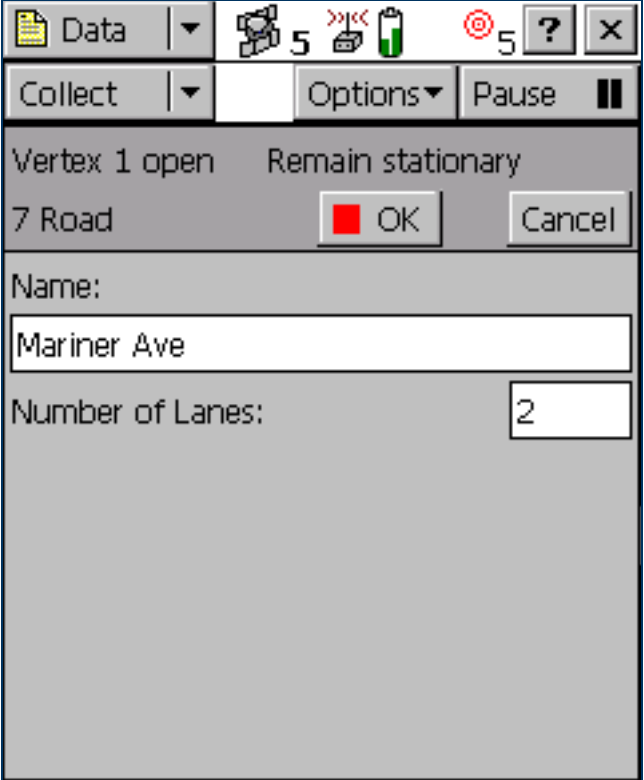

The screenshot shows the mobile application interface for recording a vertex. At the top, there is a status bar with icons for 'Data', 'Collect', 'Options', and 'Pause', along with a target icon and the number '5'. Below this, the 'Vertex 1 open' form is displayed. It includes the text 'Remain stationary', the current feature name '7 Road', and 'OK' and 'Cancel' buttons. Below the 'Name:' field, the text 'Mariner Ave' is entered. The 'Number of Lanes:' field contains the value '2'.

Because an averaged vertex is similar to a point feature, the same limitations that apply to a point feature apply when the Vertex form is open:

- You cannot segment a line feature while recording an averaged vertex.
- You can enter or edit the feature's offset, using the line/area **Offset form**.
- While the Vertex form is open, you must remain stationary, as though you were recording a point feature. The messages **Vertex # open** and **Remain stationary** appear to remind you to stay still. The number of positions recorded for this vertex also appears in the status bar.

A line or area feature can include both averaged vertices and positions logged normally as you travel. If you want to record only averaged vertices, use the Log Later function to pause logging before you open the feature. Logging starts automatically when you open the Vertex form, and returns to its former state when you close the Vertex form. Using Log Later ensures that positions are only logged when the Vertex form is open. For more information, see **Advanced datalogging options**.

Using corrections from a VRS

A virtual reference station (VRS™) system consists of GPS hardware, software, and communication links. It uses data from a network of base stations to provide rovers with corrections that are more accurate than corrections from a single base station.

Overview

To start using VRS corrections, the rover sends its position to the VRS server. A VRS server is a computer running VRS software such as Trimble's GPSNet™ software. The VRS server uses the base station data to model systematic ephemeris, tropospheric, and ionospheric errors at the rover position. It then sends interpolated RTCM correction messages back to the rover.

Depending on the VRS software, the VRS server may also use the data from the base station network to simulate a base station (or VRS) at the rover's location.

If no network corrections are available, the VRS server may switch to raw mode. In raw mode the server simply relays the corrections from the single physical base station that is closest to the rover.

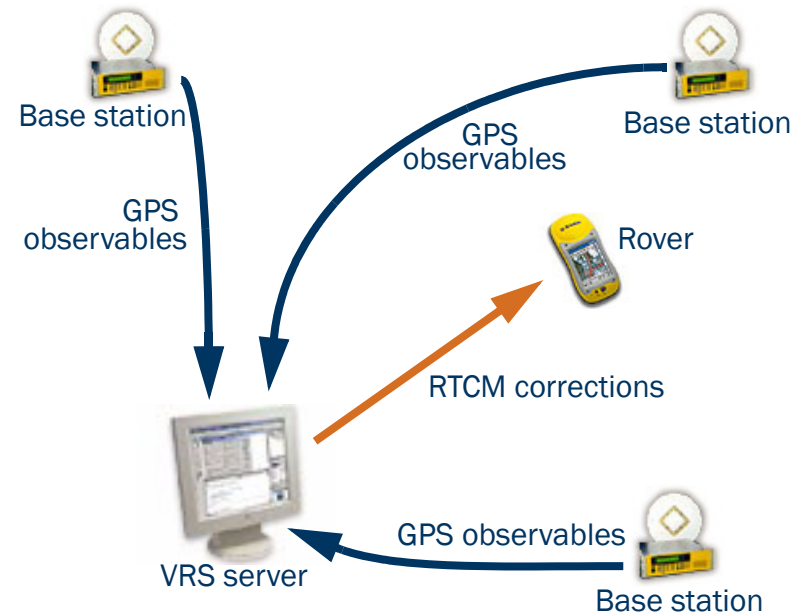

Supported receivers

You can use VRS corrections from TerraSync with:

- the following GeoExplorer CE series handhelds with GPS firmware version 1.03 or later:
 - GeoXT
 - GeoXM
- the following GPS Pathfinder receivers with firmware version 1.52 or later:
 - GPS Pathfinder Power
 - GPS Pathfinder Pro XRS
 - GPS Pathfinder Pro XR
- 5700 receiver with GPS firmware version 1.30 or later
- 5800 receiver with GPS firmware version 1.10 or later

VRS formats

There are two VRS message formats in common use: the Trimble VRS format, and the SAPOS FKP format used in some German networks. Although SAPOS FKP is not technically a VRS, it achieves similar results by transmitting network corrections.

TerraSync can receive messages in either Trimble VRS or SAPOS FKP format, and automatically recognizes the message format. However, TerraSync can only interpret VRS corrections if the VRS server generates RTCM Type 1 messages. The VRS server may also output a number of additional message types.

There are currently two commercial VRS server software products: GPSNet from Trimble, and GNNET from Geo++. Both systems can output RTCM messages in either the Trimble VRS format or the SAPOS FKP format.

Connecting to the VRS server

A VRS system requires two-way communication between the VRS server and the rover. The rover must send its position to the server, so that the server can calculate corrections for that position, and select the closest base station if necessary. Because the VRS server generates a unique VRS for each rover, it must send separate corrections to each rover.

This two-way connection can be achieved in three ways:

- **Internet connection method**

An Internet connection to a VRS server can be achieved in a number of ways, including:

- using a GPRS-capable cellphone to establish a data link over a GPRS network
- using a cellphone to make a voice call to an Internet Service Provider (ISP)

- **Direct dial connection method**

This is a voice call, using a cellphone that is connected to a modem, or a cellphone that has an internal modem, to dial up the VRS server directly.

- **Serial port connection method**

To connect to a VRS server that outputs corrections in the old German SAPOS format, you must use a decoder box connected to a serial port on the field computer.

Internet connection method

The Internet connection method uses an existing Internet connection on the field computer. TerraSync does not control or configure the Internet connection. In TerraSync, you only specify the IP address or URL of the VRS server, and the IP port on the server to connect to.

You can connect to the Internet in a number of ways, including:

- using a GPRS- or CDMA-capable cellphone to log in to your account on the cellular service provider's network. This is called an "always-on" connection, because you are connected continuously to the Internet. An always-on connection is usually charged by the volume of data you transfer, not call time. This connection type transmits only digital data, and does not use a voice call.
- using a modem connected to a data-capable GSM cellphone to dial up your Internet Service Provider (ISP) and establish a TCP/IP connection. Because it is a voice call, a GSM connection is charged by connection time, so it is often more expensive than an always-on connection.
- connecting over a wireless LAN (an 802.11b connection).

These connections can be achieved using many different hardware configurations. For example, if you use a modem and cellphone, the modem may be an internal modem in the field computer, an internal modem in the cellphone, an external modem, or a cellular (wireless) modem, which combines the functions of a cellphone and a modem. The hardware components may be connected by cable, or by a wireless link such as Bluetooth or infrared.

Before you begin

For an Internet connection, you need the following information from the VRS provider:

- The IP address or URL of the VRS or broadcast server
- The port number on the VRS or broadcast server to connect to
- A username and password for logging in to the VRS server, if the VRS server charges a connection fee

Configuration

To configure TerraSync to establish an Internet connection to a VRS source:

1. Use the Control Panel or the Remote Connections control to set up and test the Internet connection.
2. Start TerraSync and open the Setup section.
3. Tap **Real-time Settings**. The Real-time Settings form appears.
4. In the Choice 1 field, select External Source.
5. Configure the external source:
 - a. Tap the Setup button beside the Choice 1 field. The **External Source Settings form** appears.
 - b. In the Type field, select VRS.
 - c. In the Connection Method field, select Internet.
 - d. In the Address field, enter the IP address or URL of the VRS server or **broadcast server** that is supplying the VRS corrections. A broadcast server manages authentication and password control for a network of VRS servers, and relays VRS corrections from the selected VRS server to TerraSync.

- e. In the Port field, enter the port number that you will use to connect to the VRS server.
 - f. If you are connecting to a VRS server through a broadcast server, tap the Setup button  beside the Source field. TerraSync attempts to establish a connection to the broadcast server. If the connection is successful, the **Select Server form** appears. Select the VRS server that you want to use, and then tap **OK** to return to the External Source Settings form.
 - g. If you have selected a VRS server that requires authentication, the Name and Password fields appear. Enter the username and password that you obtained from the VRS provider.
 - h. In the Connection Control field, select Auto if you want TerraSync to automatically establish and end connections to the VRS server as necessary. Select Manual if you want to connect or disconnect only when you tap **Options** in the Setup screen.
 - i. Tap **OK** to confirm the settings and return to the Real-time Settings form.
6. Tap **OK**.

Using an Internet connection

To use an Internet VRS connection:

1. Use the Control Panel or the Remote Connections control to connect to the Internet.

TIP – Use Pocket Internet Explorer to check that the Internet connection is working.

2. Connect to the VRS server:
 - a. Run TerraSync and open the Setup section.
 - b. If TerraSync is not connected to the GPS receiver, tap the GPS button to connect to the GPS receiver.
 - c. If you selected the Auto option in the Connection Control field, TerraSync automatically initiates the connection to the VRS server. If you selected the Manual option, you must initiate the connection to the server. To do this, tap **Options** and select Connect to External Source.
3. Proceed with data collection. Use the Real-time Summary screen in the Status section if you want to check the VRS status.
4. When you have finished using the VRS correction source:
 - a. To disconnect from the VRS server, in TerraSync's Setup section tap **Options**. Select Disconnect from External Source.
 - b. If you have finished using the Internet, use the Control Panel or the Remote Connections control to disconnect from the Internet.

Direct dial connection method

The direct dial connection method uses a cellphone and modem, or a cellular modem, to dial up the VRS server directly. Unlike the Internet connection method, a direct dial connection is configured, established, and terminated from within TerraSync.

Authentication

If the call is authenticated using Caller ID, you will need to inform the VRS provider of the cellphone number that you are using. Otherwise, you may need to configure the modem to use a terminal window after dialling.

Before you begin

For a direct dial connection, you need the following information from the VRS provider:

- The dial-up telephone number of the VRS server
- Your VRS username and password, if the VRS provider requires you to enter these details when you connect to the server

Configuration

To configure TerraSync to establish a direct dial connection to a VRS source:

1. Install any software or drivers for the modem.
2. Start TerraSync and open the Setup section.
3. Tap **Real-time Settings**. The Real-time Settings form appears.
4. In the Choice 1 field, select External Source.
5. Configure the external source:
 - a. Tap the Setup button beside the Choice 1 field. The **External Source Settings form** appears.
 - b. In the Type field, select VRS.
 - c. In the Connection Method field, select Direct Dial.
 - d. In the Modem Type field, select the modem that you want to use. Then tap the Setup button to open the Connection Properties form.
 - e. Specify appropriate port connection settings. For detailed connection information, refer to the documentation for the cellphone or cellular modem.
 - f. If the call is authenticated with a username and password, select the Use terminal window after dialing check box.
 - g. Tap **OK** to return to the External Source Settings form.
 - h. In the Phone Number field, enter the telephone number of the VRS server, including any prefix or area code required.
 - i. In the Connection Control field, select Auto to automatically connect to and disconnect from the VRS server as necessary. Select Manual to only connect or disconnect when you tap **Options** in the Setup screen.
 - j. Tap **OK** to confirm the settings and return to the Real-time Settings form.
6. Tap **OK**.

Using a direct dial connection

To use a direct dial connection:

1. Connect to the VRS server:
 - a. If TerraSync is not connected to the GPS receiver, tap the GPS button to connect to the GPS receiver.
 - b. If you selected the Auto option in the Connection Control field, TerraSync automatically initiates the connection. If you selected the Auto option, you must initiate the connection to the server. To do this, tap **Options** and select Connect to External Source.
 - c. If necessary, enter your username and password in the terminal window that appears.
2. Proceed with data collection. Use the Real-time Summary screen in the Status section if you want to check the VRS status.
3. When you have finished using the VRS correction source:
 - a. To manually disconnect from the VRS server, in TerraSync's Setup section tap **Options**. Select Disconnect from External Source.
 - b. To ensure that the call is ended, use the End Call command on the cellphone.

Serial port connection method

Use a serial port connection to connect the field computer directly to a decoder box for a VRS that outputs SAPOS FKP corrections in the old format.

Before you begin

For a serial port connection, you need to know the serial communication parameters (baud rate, parity, data bits, stop bits) for the external device. Because TerraSync is directly connected to the device, no authentication information is required.

Configuration

To configure TerraSync to establish a serial port connection to a VRS source:

1. Start TerraSync and open the Setup section.
2. Tap **Real-time Settings**. The Real-time Settings form appears.
3. In the Choice 1 field, select External Source.
4. Configure the external source:
 - a. Tap the Setup button beside the Choice 1 field. The **External Source Settings form** appears.
 - b. In the Type field, select VRS.
 - c. In the Connection Method field, select Serial Port.
 - d. In the Port field, select the COM port on the field computer that the external source is connected to.
 - e. Tap the Setup button beside the Port field to open the **Serial Port Settings form**.

- f. Specify appropriate port connection settings. For detailed connection information, refer to the documentation for the external correction source.
 - g. Tap **OK** to return to the External Source Settings form.
 - h. Tap **OK** to confirm the settings and return to the Real-time Settings form.
5. Tap **OK**.

Using a serial port connection

To use a serial port connection, connect to GPS, and then make sure that the decoder box is turned on and is receiving corrections. For more information, refer to the documentation for the decoder box.

High-accuracy data collection

To achieve high accuracy for GPS positions, you need to use carrier phase data collection methods. Normally, GPS positions are calculated using **code phase** measurements: how long it takes for the unique code generated by each satellite (its **PRN**) to reach the receiver. For greater accuracy, you can use **carrier phase** measurements, which work with the carrier signal that the PRN code is carried on. Carrier phase measurements are much more accurate, because the carrier signal has a much higher frequency than the PRN code, and this makes errors smaller.

In TerraSync, there are two ways to use carrier phase measurements:

- You can log *postprocessable carrier phase data* from a GPS Pathfinder Pro XR, Pro XRS, or Power receiver, or from a GeoXT handheld. This data can be postprocessed in the GPS Pathfinder Office software to achieve accuracy of 30 cm or less. For more information, see [Collecting carrier phase data for postprocessing](#).
- You can use a 5700 or 5800 receiver to receive *real-time kinematic (RTK) measurements* from an RTK base station. RTK positions have an accuracy of up to 1 cm. When TerraSync is operating in RTK mode, you cannot log uncorrected positions, and any RTK positions logged cannot be postprocessed. For more information, see [Real-time kinematic \(RTK\) data collection](#).

Collecting carrier phase data for postprocessing

When you need to collect a feature with a postprocessed precision of better than 30 cm, you can configure the TerraSync software to log **carrier phase** data. When the TerraSync software logs carrier phase data, positions collected in the field can be postprocessed in the office to generate more precise positions. Because measurements are collected from each individual satellite, the positions generated during postprocessing are *more precise* than positions logged in the field.

You require a clear view of the sky at all times when collecting carrier phase data, so avoid obstacles such as trees, bridges, and tall buildings. Choose a time of day when you can expect to track a maximum number of satellites with the best possible geometry.

NOTE — Carrier phase data collection is not available when you are using a GPS Pathfinder Pocket receiver or a GeoXM handheld. If you are using a 5700 or 5800 receiver, you can achieve high accuracy in real time using **Real-time kinematic (RTK) data collection**.

This section includes the following topics:

- **Collecting sufficient data**
- **Configuring carrier accuracy features**
- **Logging carrier phase data**

Collecting sufficient data

To provide sufficient carrier phase data to achieve the required precision, the TerraSync software needs to log data from at least *four* satellites for the minimum time specified. “Loss of lock” occurs when the number of available satellites drops below four.

When you are logging carrier phase data, as soon as four or more satellites are available a counter starts. When the minimum time has elapsed, all of the carrier phase data recorded during *that* period can be used during postprocessing. When the counter reaches the minimum time, a success beep sounds. This indicates that the current “block” contains sufficient useful data.

For more information, see [What is a “block” of data?](#).

NOTE — The minimum time for a “block” of carrier phase data is 10 minutes. You cannot change this value.

If you lose lock before the end of the minimum time, the data collected since the start of the block may not provide the required precision during postprocessing. The counter is automatically reset to zero when loss of lock occurs. It only restarts when lock is regained.

NOTE — Carrier phase data is not logged from satellites that are below the current [Min Elevation](#). Before logging carrier phase data, check that the minimum elevation is set to an appropriate value.

What is a “block” of data?

When you start a file, the TerraSync software starts to record carrier phase measurements. Useful data is not stored as one continuous stream, however, but as a series of “blocks”. The beginning and end of each block is determined by the number of available satellites. As soon as four or more satellites are available, a new block begins. This block continues until lock is lost. When lock is regained, a new block begins. The TerraSync software continues to create blocks of data throughout the file.

Configuring carrier accuracy features

You can configure individual feature types in a data dictionary to use carrier phase data. You can do this when you create the data dictionary in the Data Dictionary Editor utility in the GPS Pathfinder Office software, or in the Data section’s **File Manager screen**. For more information, refer to the Data Dictionary Editor Help.

Alternatively, you can set any feature type to carrier accuracy in the TerraSync software. To do this:

1. In the **Data section**, open the data file that you want to record carrier data to.
2. Tap the Section list button and select Setup to open the **Setup section**.

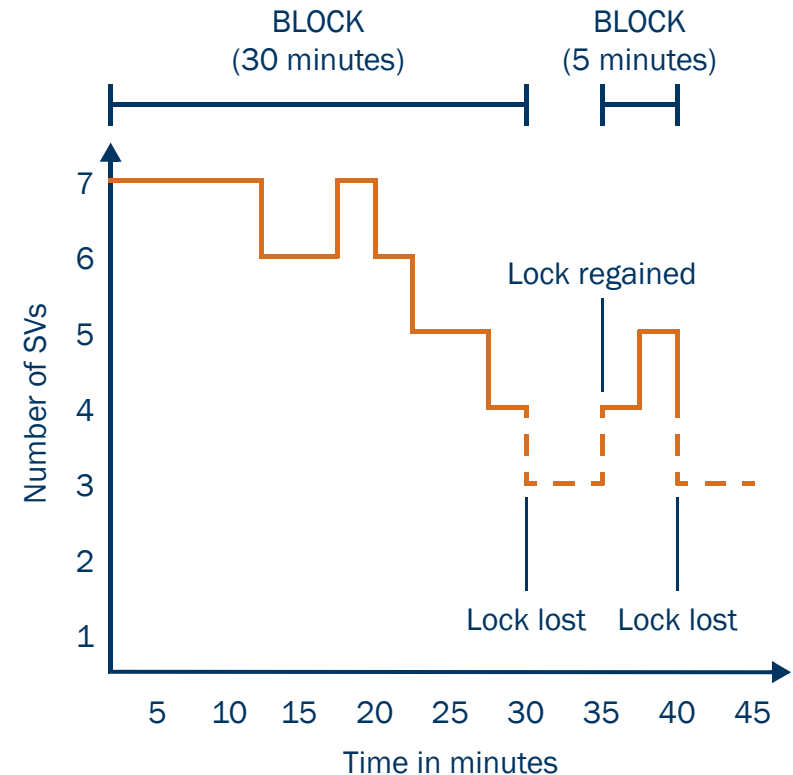

3. Tap **Logging Settings**. The **Logging Settings form** appears. At the end of the form, there is a section for each feature type in the open data file.
4. Locate the section for the feature type you want to set to carrier accuracy.
5. Make sure that the Style field is set to Time.
6. In the Accuracy field, select Carrier.
7. Tap **OK** to close this form and confirm the changes you have made.

Carrier phase data logging is now enabled for all features of this type in this file.

Logging carrier phase data

When you open a new data file, the TerraSync software checks whether any features in the data dictionary are set to carrier accuracy. If any are, the TerraSync software starts to log carrier data in the background. This allows the carrier block to start as soon as you open the file, not just when you begin to log a feature. When you start a new feature that is set to carrier accuracy, the software logs carrier data in the foreground so that this feature can be processed with carrier phase accuracy. The carrier logging icon appears in the **Status bar**, and the satellite icon shows the carrier time.

When you open an existing file with carrier features, the TerraSync software does not automatically log background carrier data. Carrier logging only begins when you start logging positions to the file. These may be not-in-feature positions, position records for a new feature, or updated positions for an existing feature.

As you log carrier phase data, the satellite icon shows the time elapsed, in minutes and seconds, since the current block of data started. This is referred to as *carrier time*. This time also appears in the Carrier time field on the **Receiver screen**. When the TerraSync software has logged carrier phase data continuously for the minimum time (10 minutes), the success beep sounds.

If you try to close a file before the minimum time is up, the TerraSync software asks you to confirm that you want to close the file. If you do close the file, you may lose carrier accuracy for some features.

Once the counter is running, you can choose to end the current feature and stay where you are until the minimum time is up. When the success beep sounds, move to the next feature. Using this method, you can be sure that you have sufficient data to generate precise positions. Alternatively, if you think you are unlikely to lose lock, you can move to the next feature *before* sufficient carrier phase data has been collected. This is possible because all features recorded during a block achieve the precision associated with that block. Provided that a block eventually contains enough useful data, you can generate precise positions for any feature recorded within it.

Satellite icon showing carrier time Carrier logging icon

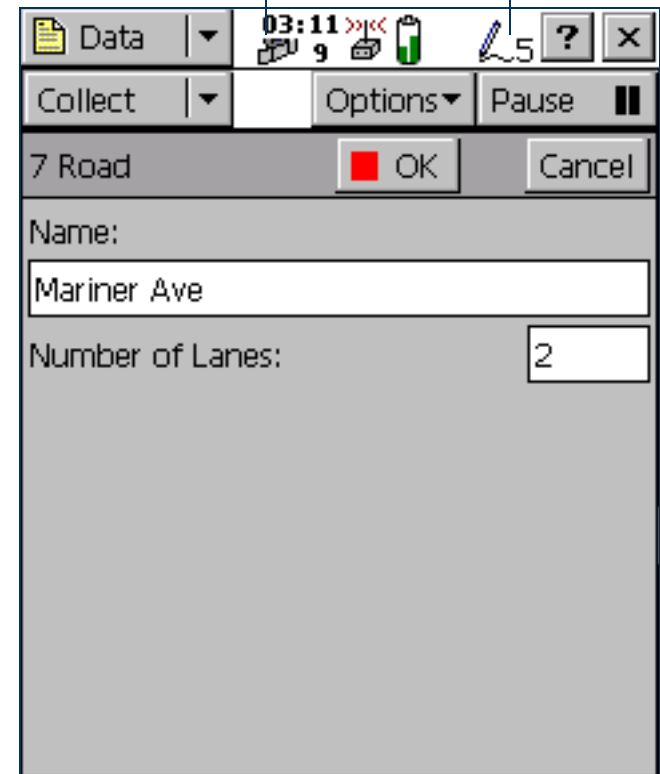

CAUTION – Only move to the next feature before the minimum time is up if loss of lock is unlikely.

Real-time kinematic (RTK) data collection

NOTE — RTK data collection is not available when you are using a GPS Pathfinder receiver or a GeoExplorer CE series handheld.

If you are using a 5700 or 5800 receiver, you can use real-time kinematic (RTK) data collection to achieve centimeter-level accuracy in real time. Like postprocessed carrier phase data collection, RTK uses **carrier phase** measurements for greater accuracy. However, when TerraSync is operating in RTK mode, GPS positions are corrected in real time.

NOTE — In RTK mode, TerraSync uses *only* RTK-corrected positions. You cannot configure the software to use uncorrected GPS positions. RTK-corrected positions cannot be postprocessed, even if you have configured TerraSync to collect SuperCorrect records or carrier phase data.

The rover can use RTK corrections from two types of source:

- another GPS receiver that is set up as an RTK base station
- a virtual reference station (VRS) that is generating RTK messages

TIP — You can use TerraSync to set up a second 5700 or 5800 receiver as an RTK base receiver. For more information, see [Setting up a base station](#).

To use RTK corrections, the rover requires a communication link to the RTK source. This can be the receiver's integrated RTK radio or an external data radio connected to the receiver. Alternatively, if you are using RTK corrections from a virtual reference station, you can use a variety of methods to establish a direct dial or Internet connection between the field computer and the VRS. For more information, see [Using corrections from a VRS](#).

This section includes the following topics:

- [Configuring TerraSync for RTK data collection](#)
- [Logging data in RTK mode](#)

Configuring TerraSync for RTK data collection

To configure TerraSync to use RTK corrections:

1. Open the Setup section.
2. Tap **Real-time Settings**. The **Real-time Settings form** appears.
3. In the Choice 1 field, select the real-time correction source:
 - If the roving receiver has an internal radio, select Integrated RTK Radio.
 - If the roving receiver is connected to an external data radio, or the RTK source is a VRS, select External Source.
4. Tap the Setup button beside the Choice 1 field to configure the correction source:
 - If you selected Integrated RTK Radio, the **RTK Radio Settings form** appears. Select the radio channel and the base radio type at the correct wireless data rate, and then tap **OK**.
 - If you selected External Source, the **External Source Settings form** appears. To use a data radio connected to the receiver, select Receiver Port in the Connection Method field, and then select appropriate settings for the other fields. To use corrections from a VRS, select appropriate settings depending on the VRS source and the communication method used. For more information, see **Using corrections from a VRS**. When you have finished configuring the external source, tap **OK**.
5. In the Choice 2 field, select Wait for Real-time.
6. Tap **OK** to confirm the real-time settings and return to the main Setup screen.

7. Set the RTK precision tolerances:
 - a. Tap **GPS Settings**. The **GPS Settings form** appears.
 - b. Tap the Setup button beside the RTK Precisions field. The **RTK Precision Settings form** appears.
 - c. Specify the minimum horizontal and vertical precision estimates for static and roving data collection.
 - d. Tap **OK**.
 - e. Tap **OK** again to confirm the GPS settings and return to the main Setup screen.

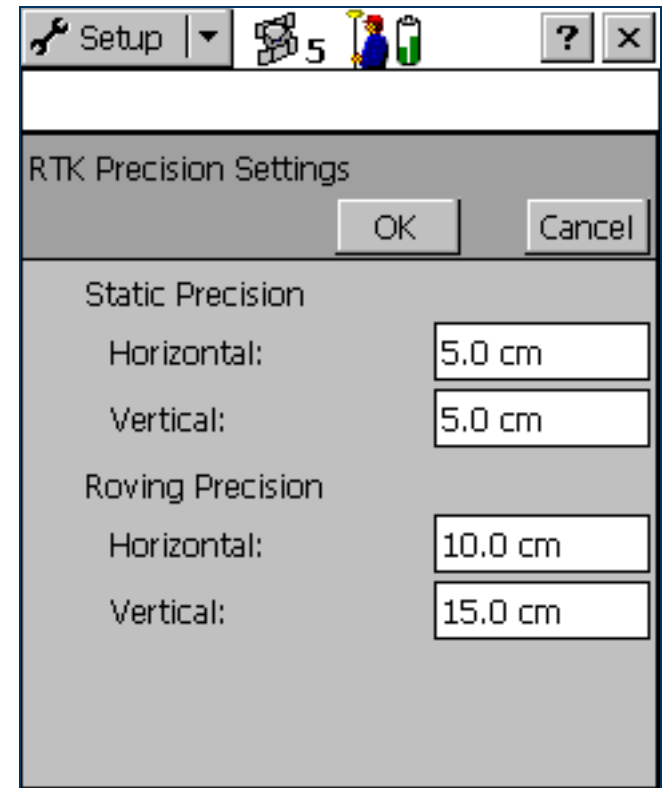

Connecting to the RTK receiver

To start using data from the RTK receiver, connect to GPS as usual. The appropriate RTK icon appears in the status bar. For example, if the receiver is using its integrated RTK radio to receive corrections, the integrated RTK radio icon  appears.

Once the receiver is connected, it starts initializing RTK mode. While the receiver is initializing, the RTK icon flashes. When the icon stops flashing, RTK mode is initialized, and you can start using positions from the receiver.

TIP – The 5700 and 5800 receivers are designed to initialize while moving. Depending on the GPS constellation, and the physical environment you are in, moving around may decrease the time required to initialize. However, if you need to initialize in **static mode** (for example, if the RTK communications link fails while you are logging a point feature), moving around *increases* the initialization time. To initialize in static mode, remain stationary and hold the GPS antenna still.

Logging data in RTK mode

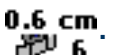
An RTK receiver can estimate the horizontal and vertical precision for each position it calculates. The horizontal precision of the most recently logged position appears over the satellite icon in the status bar  0.6 cm.

TerraSync uses these estimates to reject any positions that do not fall within the precision tolerances you have specified. For example, you can specify that all positions must have a horizontal and vertical precision of 10 cm or less. If the GPS receiver calculates a position that does not meet both these precision requirements, TerraSync does not log that position.

During RTK data collection, positions are logged either in **static mode** or in **roving mode**. In roving mode, all positions that meet the roving precision tolerances are logged. Area features, line features, and between feature positions are logged in roving mode.

In static mode, only the position with the best precision estimate is logged. Static mode is used for logging point features and vertices. Instead of logging all positions, and then averaging them to get a more accurate position for the point or vertex, TerraSync uses only the single best position, and discards all the others.

In static mode, there is no minimum number of positions that you have to record. Instead, you only need to collect one position that is within the precision tolerances you require. To do this, simply remain stationary until the logging icon in the status bar  1 shows the number 1. This indicates that TerraSync has logged a position with suitable precision estimates. As soon as the number beside the logging icon changes to 1, you can stop logging and move on to the next feature or vertex.

Setting up a base station

You can use TerraSync to configure a GPS receiver as a base station. Depending on the type of GPS receiver you use for the base station, you can set up the base station for the following operations:

- **Logging base data to a file**, which can be used to postprocess rover data in the GPS Pathfinder Office software.
- **Generating real-time corrections** to **DGPS** or **RTK** rovers.

The base receiver must be a receiver that is supported by TerraSync. It must be capable of carrier phase data collection. The table below shows the GPS receivers that can be used, and the base station operations that each receiver supports:

GPS receiver	Log to base file	Output DGPS corrections	Output RTK corrections
GeoXT	✓		
GPS Pathfinder Power	✓	✓	
GPS Pathfinder Pro XR	✓	✓	
GPS Pathfinder Pro XRS	✓	✓	
5700		✓	✓
5800		✓	✓

By default, if you enable real-time output for a GPS Pathfinder receiver, it still logs base data to file. If you only want to output real-time corrections from a GPS Pathfinder receiver, or if you are using a 5700 or 5800, you can use TerraSync to set up the receiver as an **Unattended base station**.

Logging base data to a file

The following receivers can log base data to a file, for use in the GPS Pathfinder Office software:

- GPS Pathfinder Power
- GPS Pathfinder Pro XR
- GPS Pathfinder Pro XRS
- GeoXT

To log base data to a file, open the **New File subsection** and start a new base data file. Then follow the **Base Station Setup wizard**.

Generating real-time corrections

To broadcast real-time corrections, configure the base receiver to generate real-time correction messages. Then connect the base receiver to a data radio, such as a TRIMTALK™ or TRIMMARK™ radio, which broadcasts the correction messages.

NOTE — You cannot use the internal RTK radio in a 5700 or 5800 receiver to broadcast correction messages.

GPS Pathfinder Power, Pro XR, and Pro XRS receivers can output **DGPS** corrections, in the **RTCM** message format. These corrections can be used by any rover that can use RTCM corrections from an external source, such as a GPS Pathfinder receiver or a GeoExplorer CE series handheld.

In addition to DGPS corrections in RTCM format, 5700 and 5800 receivers can also output **RTK** corrections, in RTCM, **CMR**, or CMR+ format. RTK corrections can only be used by RTK-capable rover systems, such as a 5700 or 5800 receiver connected to a field computer running TerraSync version 2.40 or later.

The correction types and message format that you choose depend on the capabilities of the roving receivers that will use the corrections.

To output real-time corrections:

1. Open the **New File subsection** and start a new base data file.
2. Follow the **Base Station Setup wizard**. In the **Real-Time Output step**, do the following:
 - a. Set the Correction Output field to Receiver Port.
 - b. Choose an appropriate output format and message settings.
 - c. If you want to supply power to the data radio, select the appropriate option (Auto or On) in the Receiver Power Output field.

WARNING — Enabling power output can damage some CE devices. Trimble recommends that you always select the Auto option unless you require power to the data radio *and* have protected the CE device from power supplied by the GPS receiver. For more information, see **Receiver power output**.

- d. Tap the Setup button beside the Correction Output field. The Receiver Port Settings form appears. Configure the receiver's communication settings (baud rate, data bits, stop bits, and parity) to match those used by the data radio.

NOTE — You cannot use TerraSync to configure the data radio's communication settings. You can only configure the receiver to use the same settings as the radio. To change the data radio's communication settings, use the configuration software that is provided with the radio.

Unattended base station

If you do not want to log base data for postprocessing, or if the base receiver can only output corrections, you can set up the receiver as an unattended base station. An unattended base station, once set up, continues to operate without any controlling software. After you have used TerraSync to configure the base receiver, and the base station has started broadcasting corrections, you can disconnect the field computer and connect it to the roving receiver.

To set up an unattended base station:

1. Connect the field computer that TerraSync is installed on to the base receiver.
2. In the Data section, open the **New File subsection** and start a new base data file.
3. Follow the **Base Station Setup wizard**. In the **Real-Time Output step**, make sure that you set the Correction Output field to Receiver Port, to enable real-time output.
4. If the base receiver is a 5700 or 5800, a message appears before the new base file is opened, warning you that you cannot collect base data using this receiver. Tap **OK** to continue.
5. To confirm that the receiver is generating correction messages, make sure that the base station icon is visible in the status bar.
6. Disconnect TerraSync from the base receiver. Do one of the following:
 - Physically disconnect the field computer from the base receiver.
 - In TerraSync, disconnect from GPS.
 - Exit TerraSync *without* closing the base file.

TIP — Whenever you close the base file while TerraSync is connected to the receiver, the receiver stops generating real-time output. If you want the base receiver to continue operating unattended, do not close the base file before disconnecting from the base receiver.

Coordinate systems

When using the TerraSync software to collect GPS data, you can configure the coordinate system, zone, and datum. This lets you enter and display coordinates using the coordinate system that best suits you and the location you are working in. The following topics are discussed:

- **Coordinate systems and datums**
- **Coordinate systems available in the TerraSync software**
- **Using the Coordinate System Manager utility**
- **Transferring coordinate systems**
- **Configuring coordinate systems**

Coordinate systems and datums

Coordinate systems are three-dimensional reference frames used to describe the location of objects in space. The TerraSync software provides you with your position anywhere on the earth's surface in relation to the coordinate system you have configured.

Before you can compare geographic data obtained from different sources, all the data must be referenced to the same **datum** and coordinate system. This is because different datums and coordinate systems provide different coordinate values for a single geographic location.

GPS positions are normally expressed as latitudes and longitudes relative to a mathematical model called a datum. The datum used by GPS is called the World Geodetic System 1984 datum (or WGS-84). A datum is defined by the relationship between an **ellipsoid** and an origin point. An ellipsoid is a three-dimensional surface shaped like a squashed sphere, which approximately models the shape of the earth (either as a whole, or over a particular part of the earth). The WGS-84 datum is defined in terms of the GRS-80 ellipsoid.

For most land-based GPS applications, and particularly for GIS data collection applications, latitudes and longitudes are much less convenient. Typically, a GIS will represent the coordinates of geographic features in a locality of interest using a rectangular grid (running North and East) and will presume that the earth is locally flat. A local ellipsoid can be defined to provide a good approximation to the shape of the earth in that area. A datum transformation and a map projection are then used to transform coordinates from this local ellipsoid to the flat-earth model in the GIS.

Heights can be displayed by the TerraSync software relative either to a local ellipsoid, or to an empirically defined surface known as the **geoid**. The geoid is a surface over which the earth's gravity is constant. (The geoid represents mean sea level.)

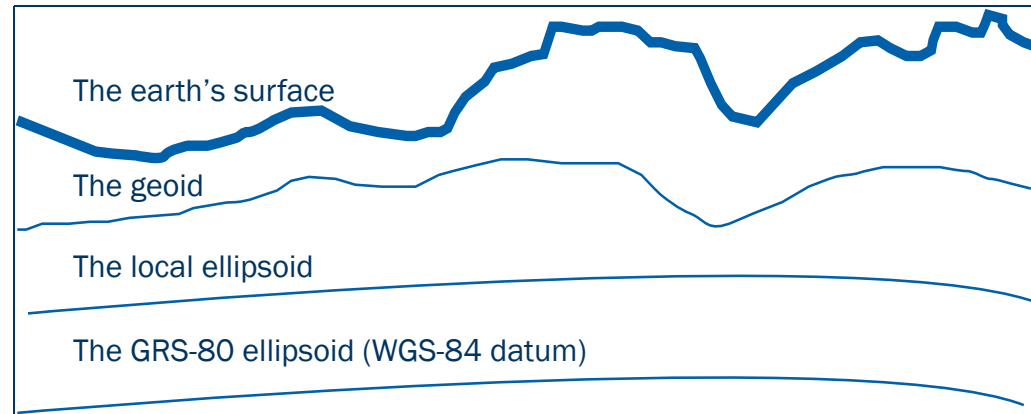

In summary, there are three models for describing geographic locations:

- The flat North, East model of the GIS, possibly with heights as well
- The curved local ellipsoid, used by the GIS as a model of the earth's surface locally
- The curved GRS-80 ellipsoid, used by GPS as a model of the earth's surface as a whole

These models can describe heights as being relative to either an **ellipsoid** or the **geoid** (mean sea level).

To collect the positions of features using GPS (and hence the WGS-84 datum) and then send them to a GIS as North, East coordinates, the GPS latitudes and longitudes need to be processed in a number of ways.

First, they need to be transformed from latitudes, longitudes, and altitudes on the WGS-84 datum into latitudes, longitudes, and altitudes on the local datum. This operation is called a *datum transformation*.

Once the coordinates are expressed as latitudes and longitudes on the local datum, they must then be projected into North and East values on a flat grid, using an operation called a *map projection*. Finally, if altitudes are to be stored by the GIS, they need to be transformed from heights above the GRS-80 ellipsoid to heights above some other reference level. The most common reference level is the geoid, more commonly referred to as mean sea level. The TerraSync software and the GPS Pathfinder Office software both contain a geoid separation model which enables them to transform altitudes relative to GRS-80 into heights relative to mean sea level.

NOTE — Data files are stored using the current coordinate system. If you change coordinate system, the current data file's coordinates are recalculated, which may take some time.

NOTE — Each background image is associated permanently with a coordinate system. To display correctly when opened, a background image's coordinate system must match the current TerraSync coordinate system.

TIP — If no coordinate system has been assigned to an image when you open it in the background, TerraSync associates it with the current coordinate system. To change the coordinate system that is associated with a background image, change the image's coordinate system in the GPS Pathfinder Office software and transfer the image to TerraSync again. Alternatively, delete the corresponding .cs file in the TerraSync documents folder, change to the required coordinate system in TerraSync, and open the image in the Map background.

The geoid separation models used by the TerraSync software and the GPS Pathfinder Office software differ in accuracy. TerraSync is necessarily approximate, while GPS Pathfinder Office is more accurate. If you require altitudes relative to a different reference level, or relative to a more accurate (perhaps local) mean sea level model, you will need to process the heights in GPS Pathfinder Office before exporting them to the GIS.

The TerraSync software lets you specify a datum transformation and a map projection so that you can see your GPS position (and the position of features you may have recorded) in the local coordinate system. This makes it easy for you to check your position or to navigate using a map produced by your GIS. It also lets you specify whether heights will be shown relative to the local ellipsoid, or relative to mean sea level.

For your convenience, the TerraSync software hides the complexities of datum transformations and map projections behind the common names for the coordinate systems with which you may be familiar. Each named coordinate system has an associated datum (which encapsulates an ellipsoid) and a number of zones (each of which is a named instance of a particular map projection).

Coordinate systems available in the TerraSync software

The TerraSync software is supplied with a large number of coordinate systems and datums, including most National Coordinate Systems.

You can also create your own coordinate systems and sites using the Coordinate System Manager utility in GPS Pathfinder Office. You can easily load these coordinate systems into the TerraSync software using the Trimble Data Transfer utility.

NOTE — The default geoid in the TerraSync software is the DMA 10x10 (Global) model. This is different from the default used by the GPS Pathfinder Office software. As a result, MSL heights in the TerraSync software may differ from those displayed in the GPS Pathfinder Office software.

Using the Coordinate System Manager utility

Use the Coordinate System Manager utility in GPS Pathfinder Office to create and edit custom coordinate systems and sites for use with the TerraSync software. This data can be saved to a coordinate system export file, which you can then transfer to the field computer.

To use the Coordinate System Manager utility:

1. On the office computer, start the Coordinate System Manager utility from GPS Pathfinder Office.
2. Use the tabs in the main window to select or edit coordinate systems, zones, and sites.

CAUTION — When you transfer a new coordinate system file to the field computer, it replaces all coordinate systems already stored in the TerraSync software. Make sure that the new file includes all the coordinate systems that you want to use in the TerraSync software.

3. Export the coordinate system database file. Select File / Export. The Export dialog appears.
4. Select the Selected records only option in the Export dialog.
5. Click **OK**. The Save As dialog appears.
6. Specify the filename and click **Save**.

When you have saved the coordinate system database files and the related support files, use the Data transfer utility to transfer the coordinate system export file to the TerraSync software. For more information, see [Transferring a coordinate system export file](#).

For more information on using the Coordinate System Manager utility, refer to the GPS Pathfinder Office Help.

Transferring coordinate systems

There are two ways to transfer coordinate systems or sites to the TerraSync software. You can transfer a single coordinate system or site which you select at the time of transfer. Alternatively, you can use the Coordinate System Manager utility to create a coordinate system *export file* that contains a number of coordinate systems, zones, datums and sites, and then transfer this file to the TerraSync software.

The TerraSync software stores all its coordinate systems in one file. When you load a new coordinate system into the TerraSync software, the new file *replaces* any existing coordinate system or systems in the software. If you transfer a single coordinate system or site, all existing systems in the software are lost. If you transfer a coordinate system export file, make sure that you include any coordinate systems that you want to keep, *plus* any new systems that you want to transfer to the TerraSync software.

CAUTION — To prevent the loss of coordinate system information in the TerraSync software, Trimble strongly recommends that you transfer coordinate systems to the field computer in a coordinate system export file. This is preferable to selecting and sending a single coordinate system.

There are two procedures for transferring coordinate system data to the TerraSync software:

- **Transferring a coordinate system export file**
- **Transferring a single coordinate system**

Transferring a coordinate system export file

Use the Trimble Data Transfer utility to transfer a coordinate system export file to the TerraSync software. A coordinate system export file can contain a number of coordinate systems and sites.

To transfer a coordinate system export file:

1. Connect the field computer to the office computer, start the Data Transfer utility, and connect to the appropriate device definition. For detailed instructions on these steps, see [Transferring data to the field computer](#).
2. Select the Send tab.
3. Click **Add** and select Coordinate System Export File from the drop-down list. The Open dialog appears, showing all coordinate system export (.cse and .csw) files in the default location for coordinate system files, C:\Program Files\Common Files\Trimble\Geodata.
4. Browse for the correct drive and folder if necessary, then select a .cse file and click **Open**.

NOTE — If you select more than one .cse or .csw file to send, only the coordinate systems in the last file you transfer will be loaded into the TerraSync software. Each transferred file replaces any previously transferred files.

5. The Open dialog disappears. The selected coordinate system export file is added to the Send list in the Data Transfer dialog.
6. Click **Transfer**.
7. If coordinate systems or sites in the selected export file reference other files such as geoid grid files, the Associated Files dialog appears. Select the appropriate check box to send each file you require, and then click **OK**.

The selected coordinate system export file and any associated files are transferred to the CE device, replacing any coordinate systems stored in the TerraSync software.

For more information, refer to the GPS Pathfinder Office Help.

Transferring a single coordinate system

CAUTION — To prevent the loss of coordinate system information in the TerraSync software, Trimble strongly recommends that you transfer coordinate systems to the field computer in a coordinate system export file. This is preferable to selecting and sending a single coordinate system.

Use the Trimble Data Transfer utility to transfer a single coordinate system to the TerraSync software.

To transfer a coordinate system:

1. Connect the field computer to the office computer, start the Data Transfer utility, and connect to the appropriate device definition. For detailed instructions on these steps, see [Transferring data to the field computer](#).
2. Select the Send tab.
3. Click **Add** and select Coordinate System from the drop-down list. The Coordinate System dialog appears.
4. In the Select By group, select the appropriate option for sending a coordinate system or a site.
5. Select the options in the Site, System, Zone, and Datum fields that match the coordinate data you want to send. Some of these fields are read-only or hidden, depending on the selections in other fields.

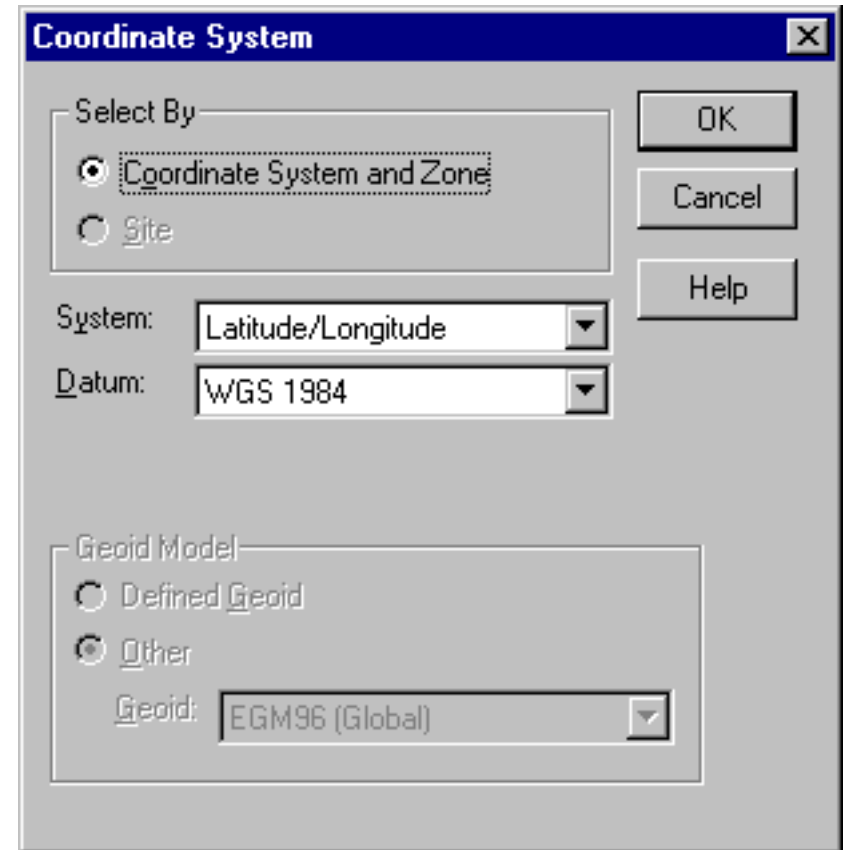

The screenshot shows the 'Coordinate System' dialog box. It has a title bar with a close button (X). The dialog is divided into several sections:

- Select By:** A group box containing two radio buttons: 'Coordinate System and Zone' and 'Site'.
- System:** A dropdown menu currently showing 'Latitude/Longitude'.
- Datum:** A dropdown menu currently showing 'WGS 1984'.
- Geoid Model:** A group box containing two radio buttons: 'Defined Geoid' and 'Other'. Below this is a dropdown menu for 'Geoid' currently showing 'EGM96 (Global)'.
- Buttons:** 'OK', 'Cancel', and 'Help' buttons are located on the right side of the dialog.

6. Click **OK**. The Coordinate System dialog disappears. The coordinate system or site you selected is added to the Send list in the Data Transfer dialog.
7. Click **Transfer**.
8. If the selected coordinate system references other files such as geoid grid files, the Associated Files dialog appears. Select the appropriate check box to send each file that you require, and then click **OK**.

The selected coordinate system and associated files are transferred to the CE device, replacing any coordinate systems stored in the TerraSync software.

For more information, refer to the GPS Pathfinder Office Help.

Configuring coordinate systems

You can use the **Coordinate System form** to edit the coordinate system, zone, and datum parameters. The TerraSync software lets you specify a datum transformation and a map projection so that you can see your GPS position, and the position of features you collect, in your local coordinate system. This makes it easy for you to check your position or to navigate using a map produced by your GIS.

To configure the Coordinate System form:

1. Open the **Setup section**. Tap the Section button and select Setup from the drop-down list.
2. Tap **Coordinate System**.

The Coordinate System form appears:

3. Use this form to specify the coordinate system, site, zone, datum, and altitude reference. You can also specify the units used to display the coordinates and altitude.
4. Tap **OK** when you have finished.

The Coordinate System form closes and any changes you have made are applied immediately throughout the TerraSync software.

If any points in the Map section are not within the coordinate system you select, TerraSync warns you and asks you to confirm that you want to apply the new coordinate system. If you do, the map points that are outside this system are not displayed on the map.

For more information, see **Coordinate System**.

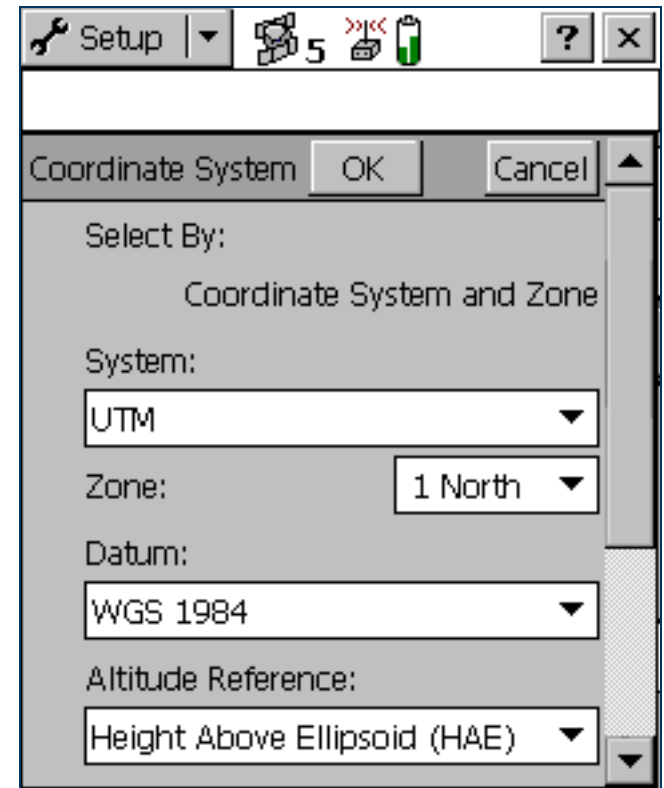

The screenshot shows the 'Coordinate System' dialog box in the TerraSync software. The title bar includes a 'Setup' dropdown menu, a '5' icon, a red 'X' icon, and a battery level indicator. The dialog has 'OK' and 'Cancel' buttons. The 'Select By:' dropdown is set to 'Coordinate System and Zone'. The 'System:' dropdown is set to 'UTM'. The 'Zone:' dropdown is set to '1 North'. The 'Datum:' dropdown is set to 'WGS 1984'. The 'Altitude Reference:' dropdown is set to 'Height Above Ellipsoid (HAE)'. A vertical scrollbar is visible on the right side of the form.

REFERENCE

This Reference provides detailed information about screens that appear when you use the TerraSync™ software. The first section in the Reference describes different ways to interact with the TerraSync software. It also explains how to use the keys and screens:

- **General operation**

The Reference then describes the five sections of the TerraSync software:

- **Map section**
- **Data section**
- **Navigation section**
- **Status section**
- **Setup section**

General operation

This section contains detailed information about the TerraSync user interface and data entry methods. Topics are:

- Getting help
- Windows operation
- Windows CE operation
- Starting and exiting the TerraSync software
- Section structure
- The TerraSync display
- Status bar
- Interacting with the TerraSync software

Getting help

The TerraSync Help describes only the fields and commands for each screen. For detailed information about using the TerraSync software, refer to the TerraSync Operation Guide (this document).

To access context-sensitive help, do one of the following:

- On a PC or **H/PC 2000**, tap  in any TerraSync screen.
- On a **Pocket PC**, tap  and select Help.

Help is context-sensitive. If you access the Help while the TerraSync software is running, it opens at the topic that corresponds to the current TerraSync screen.

Online help for TerraSync is displayed in HTML pages. It works in the same way as a Web page. Select any blue underlined text to jump to the topic it describes.

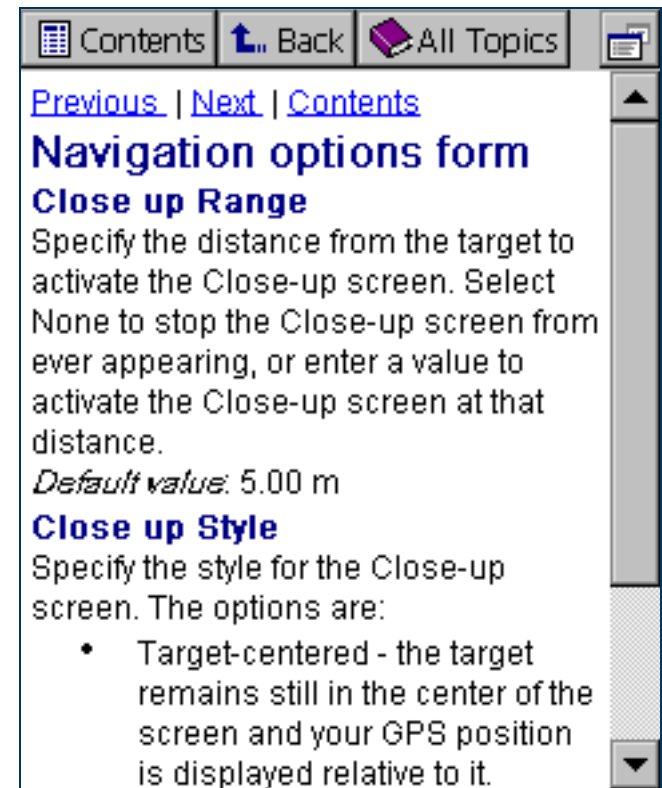

The contents page of the TerraSync Help lists all the main topics in the TerraSync Help. To access this page, do one of the following:

- Select the Contents link at the top of any TerraSync help page.
- While viewing the TerraSync Help on a Pocket PC, tap **View** and select Contents.
- While viewing the TerraSync Help on an H/PC 2000, tap **Contents**.
- From the main Help Contents topic on a CE device, select the TerraSync link.

On a CE device, the main Help Contents topic lists all the help files that are available. To access this page, do one of the following:

- While viewing the TerraSync Help on a Pocket PC, tap **View** and select All Installed Help.
- While viewing the TerraSync Help on an H/PC 2000, tap **All Topics**.
- If TerraSync is not running, tap  **Start** and select Help.

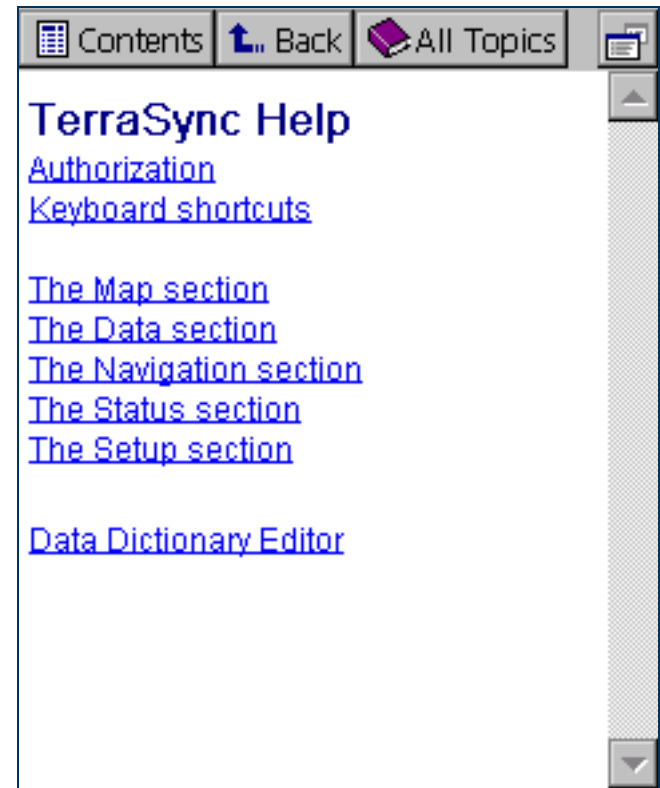

Windows operation

You can install the TerraSync software on a desktop, laptop, or tablet PC instead of on a CE device. This manual assumes that you are familiar with the Windows[®] operating system that is installed on the PC.

This manual describes the TerraSync software as it appears on a portrait orientation **Handheld PC 2000** with a 240 × 320 pixel screen. On a PC, some elements of the software are displayed differently. The main difference is that on a larger screen the TerraSync display is arranged in panes, so you can view up to three sections at the same time. For more information, see **Panes**. However, the CE device and PC displays function in the same way. Except where specified, any information in this manual that relates to the operation of TerraSync on a CE device also applies to its operation on a PC.

Windows CE operation

This manual assumes that you are reasonably familiar with the Microsoft Windows CE operating system. If you have used a Windows operating system such as Windows 98 or 2000, you will know how to use most Windows CE features. For help on Windows CE operation, select Help from the Start menu on the CE device.

The following topics contain information about some Windows CE features that are essential to the TerraSync software:

- [Changing memory allocation](#)
- [Adjusting the screen contrast](#)
- [Working with other applications](#)
- [On-screen keyboards](#)
- [Device Lock utility](#)

The following topics contain information that is specific to Trimble CE devices:

- [GeoExplorer CE series handheld](#)
- [TSCe field device](#)
- [Trimble Recon handheld](#)

Changing memory allocation

Most CE devices have a relatively small amount of random access memory (RAM), which is divided between *storage memory* and *program memory*. You can adjust the amount of available memory that is allocated to each.

Storage memory, like a hard disk on a desktop computer, is used to store files on the CE device. If you do not have enough space on the CE device, you can increase the storage memory to provide space for more files.

Program memory is used to run programs. If programs are running slowly, or the CE device displays messages warning you that program memory is low, you can increase the program memory.

TIP — If the CE device does not have any *internal* secondary storage, check the slider position regularly to ensure that the memory allocations are appropriate. Normally, you should allocate as much memory as possible to running programs. For example, if you delete files from the CE device or transfer them to the GPS Pathfinder[®] Office software, you should convert the free space to program memory. This optimizes the performance of the programs you are running. As you collect more data, check that there is sufficient storage space allocated, and increase it if necessary.

NOTE — You can only change the allocation of memory that is not currently in use.

To adjust the memory allocation:

1. On the Windows CE taskbar, tap .
2. Do one of the following:
 - On a Pocket PC, select Settings / System.
 - On a Handheld PC 2000 (H/PC 2000), select Settings / Control Panel / System.
3. Select the Memory tab.
4. Drag the slider to the left to increase program memory, or to the right to increase storage memory.
5. Tap **OK** to close the System Properties dialog.

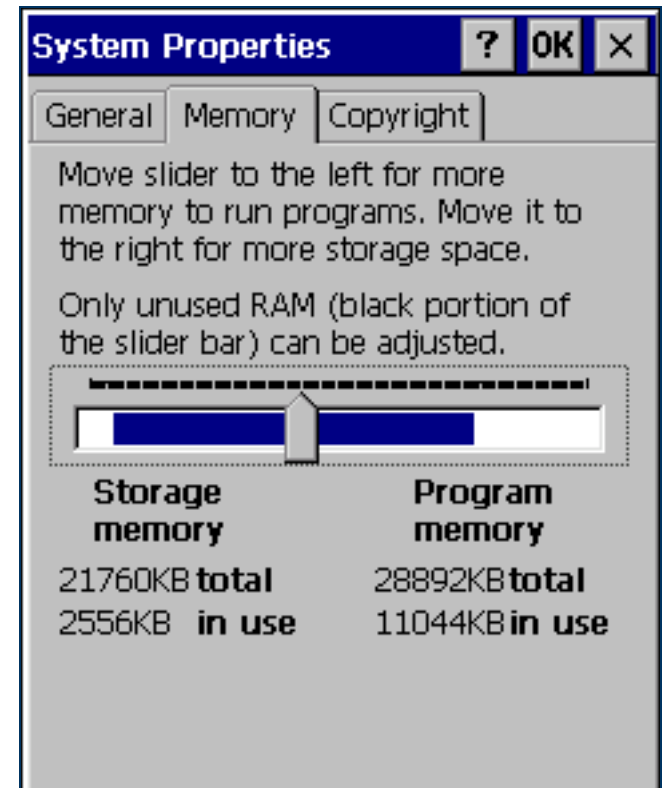

Adjusting the screen contrast

You can change the screen contrast on any CE device, to adjust to indoor or outdoor operation. Many CE devices have settings software and a hardware control for adjusting the contrast in bright or dim light. For information on changing device settings, or on locating and using hardware controls, refer to the documentation for the CE device.

Some CE devices, such as the **GeoExplorer CE series handheld** or the **Trimble Recon handheld**, have a frontlight or backlight instead of contrast control. For information on changing the lighting level, refer to the documentation for the CE device.

Working with other applications

The Handheld PC 2000 operating system is similar to a desktop Windows operating system. You can use the same methods on an H/PC 2000 device as you would on a Windows computer to start, exit, or switch between programs. For example, to switch from the active application to another application, you can tap the program's icon in the taskbar. Alternatively, if the CE device has a keyboard, you can use the **Alt** + **Tab** key combination.

On Pocket PCs, most programs do not have a close button or a menu command for exiting the program. Instead, you must use system software to shut down a particular program. If the CE device does not have a keyboard, you must also use system software to switch from the active application to another application.

To shut down or switch to a task that is running on a Pocket PC:

1. On the Windows CE taskbar, tap  **Start**.
2. Select **Settings / System**.
3. Select the **Task Manager** tab.
4. Highlight the task you want, then do one of the following:
 - To shut down the task, tap **End Task**.
 - To switch to the selected task, tap **Switch To**.
5. Tap **OK** to close the System Properties dialog.



On any CE device, tapping  / Programs / TerraSync when the TerraSync software is already running does not start the software a second time. Instead, the copy of the TerraSync software that is already open becomes the active program. You can use this method to switch back to the TerraSync software from another application.

TIP — Some CE devices have hardware buttons that start specific applications. Often you can change the program that is assigned to a particular button, or you can delete the existing program assignment so that pressing the button has no effect. Removing or changing hardware button assignments can be helpful if you frequently activate hardware buttons by accident.

On-screen keyboards

Some CE devices, such as **Pocket PCs**, do not have a physical keyboard. Instead, you can use an *on-screen keyboard* to enter text. To activate an on-screen keyboard, tap the keyboard button in the taskbar. The currently selected on-screen keyboard pops up and partially covers any screen that is open. When you have finished entering text in a field, tap Enter to accept the text you have entered and move to the next field. To hide the on-screen keyboard, press the keyboard button on the taskbar again.

An on-screen keyboard usually consists of rows of “keys”. The default keyboard shows alphabetic or alphanumeric keys, laid out like a real keyboard. As you tap each key, the corresponding character is added to the current text or numeric field in the current program.

Alternatively, an on-screen keyboard may use *character recognition*. Normally, when using a character recognition keyboard, you write with the stylus in a special field. As you draw each shape, it is translated into the corresponding character and entered into the current field. You can correct any text that is incorrectly interpreted.

You can install different on-screen keyboards on the CE device and switch between them as required. All of these keyboards are available when you use the TerraSync software. For example, you may want to use a character recognition keyboard to quickly enter a long note, an alphabetic keyboard to enter a filename, and the **Trimble numeric keyboard** to enter numeric data such as the height of a feature or a distance.

If the CE device has on-screen keyboards installed, the TerraSync software automatically displays the appropriate keyboard when you select a field that accepts data entry, and hides the keyboard when you select a control that does not accept keyboard input.

TIP — The keyboard button on the taskbar shows the icon of the currently selected on-screen keyboard.

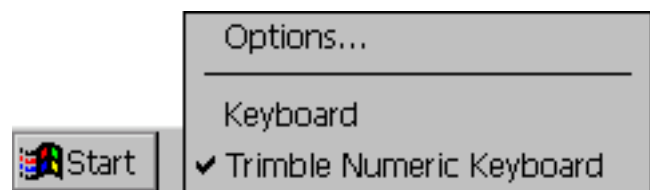

To change the selected keyboard, tap the arrow on the right end of the on-screen keyboard button. A list of installed keyboards pops up. The currently selected keyboard is indicated by a bullet or check mark. Tap the name of the keyboard you require. The pop-up list closes automatically.

Trimble numeric keyboard

When you install the TerraSync software on a CE device that uses on-screen keyboards, the Trimble numeric keyboard is also installed. This keyboard contains numeric and symbol keys that are useful when you enter numeric data or time information.

This keyboard is available to other programs on the CE device as well as to the TerraSync software.

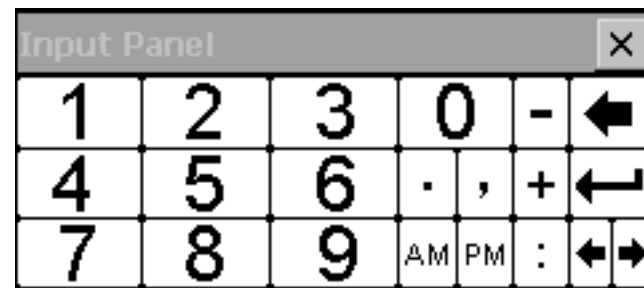

NOTE — The Trimble numeric keyboard is only available on CE devices that use on-screen keyboards, such as the Pocket PC.

Device Lock utility

The Device Lock utility is installed with TerraSync on a CE device. It lets you lock the CE device so that accidentally pressing the screen, keys, or hardware buttons has no effect. Locking the CE device lets you safely clean the screen or exterior of the CE device, transport it, or carry it.

To lock the CE device, tap  / Programs / Device Lock. The Device Lock screen appears.

Once the device is locked, the screen, hardware buttons (including Record and Power buttons), and keypad (if it has one) do not respond until the device is unlocked.

Communication with external devices such as a GPS receiver, or external sensors used by TerraSync, is not interrupted by locking the device. This means that you can keep using TerraSync when the CE device is locked. For example, you may want to lock the CE device so that you can safely transport it in your pocket between features, but keep TerraSync connected to the GPS receiver so that you can collect a continuous block of carrier phase data.

To unlock the device, use a stylus or your finger to drag the key icon onto the padlock icon.



GeoExplorer CE series handheld

The handhelds in Trimble's GeoExplorer® CE series are combined GPS receivers and **Handheld PC 2000** CE devices. The GeoExplorer CE series includes the GeoXT™ and GeoXM™ handhelds.

The GeoExplorer CE series handheld has two types of memory, which are similar to the RAM and the hard disk in a desktop PC.

The *main memory* (RAM) is used mainly for running programs, but it also stores essential files for the Windows CE operating system. The main memory is a volatile memory store, so it is cleared if the handheld loses power or is reset. However, you can back up the main memory to avoid data loss.

NOTE — In the TerraSync software and documentation, the term *RAM* is used to refer to the main memory on the GeoExplorer CE series handheld.

The *Disk* is like a PC's hard disk. It is used for storing programs and data. The Disk is non-volatile flash memory, so it is not affected by power losses or resetting.



Using the integrated GPS receiver

Most GPS applications, including TerraSync, physically connect to an external GPS receiver on a COM port. On a GeoExplorer CE series handheld, the GPS receiver is integrated with the CE device, so you do not have to make any physical connection. To use GPS data from the handheld's integrated GPS receiver, you connect using a *virtual* COM port. To the GPS application, connecting to a virtual COM port is exactly the same as connecting to a physical COM port.

By default, TerraSync is configured to connect to the correct virtual COM port (COM 3). When you run the TerraSync software for the first time on a GeoExplorer CE series handheld, TerraSync automatically activates the GPS receiver.

To connect to the GPS receiver from any other GPS application, you must select the virtual COM port that corresponds to the GPS protocol that the application uses. If the application accepts NMEA messages from the GPS receiver, connect to COM2. If the application uses TSIP messages, connect to COM3. All Trimble applications use TSIP messages to communicate with Trimble GPS receivers.

When TerraSync is installed on a GeoExplorer CE series handheld, it becomes the handheld's default GPS status application, and is associated with the F1 GPS touch button on the screen. To run TerraSync, you can either tap  Start / Programs / TerraSync, or you can simply tap the F1 GPS touch button. For more information on touch buttons, refer to the GeoExplorer CE Series Getting Started Guide.

TSCe field device

Trimble's GIS TSCe™ field device is a **Handheld PC 2000** CE device that runs either version 3.0 of the Windows CE operating system, or version 4.1 (Windows CE .NET).















The TSCe has two memory locations: RAM (the default memory location on the device) and the internal storage card (a secondary storage location). RAM is a volatile memory store that is cleared if power is lost, or a hard reset is performed on the CE device. The storage card is non-volatile memory, so these events do not affect programs and data stored on the storage card.

NOTE — In the TerraSync software and documentation, the term *Disk* is used to refer to the internal storage card on the TSCe.



Using the keyboard instead of the touch screen

To control the TSCe field device, you can use either the keyboard or the touch screen. The following table shows some common actions that you can perform with the keyboard instead of the touch screen. When more than one key is used to perform an action, you can press each key in sequence or press all keys at the same time.

Action	Keyboard shortcut
Access a drop-down menu	 and the letter key for the menu item
Move between fields	
Move between buttons	 ,  ,  , or  (arrow keys)
Tap the selected button	 (Enter key)
Select a check box	 (Space key)
Close a dialog or screen without saving changes	
Switch between programs	 
Open the Task Manager	 
Display the Start menu	 

Trimble Recon handheld

The Trimble Recon™ handheld is a **Handheld PC 2000** CE device that runs the Microsoft Windows CE .NET (Windows CE 4.1) operating system.















The Trimble Recon handheld has 64 MB of RAM, and 128 MB of internal flash memory. It also has two CompactFlash slots, so you can use CompactFlash memory cards to expand the storage space.

Unlike most other Windows CE devices, the Trimble Recon handheld has no RAM-based file system. All files are stored either in the flash memory or on an external CompactFlash card. This means that all stored data is maintained even if power is lost.





Using the keyboard instead of the touch screen

The Trimble Recon handheld has seven keys that you can use to perform common system functions, or that you can use instead of the touch screen. The following table shows some common actions that you can perform with the keyboard. When more than one key is used to perform an action, you can press each key in sequence or press all keys at the same time.

Action	Keyboard shortcut
Access a right-click (shortcut) menu	 and tap the appropriate item on the screen
Access a drop-down menu	 and tap the appropriate letter key on the on-screen keyboard
Close a dialog or screen without saving changes, or exit a menu without selecting a command	
Open the Task Manager	 and tap the taskbar
Tap the selected button, open the selected file, or perform the default action in a dialog or screen	 (Enter key)
Switch between programs	 
Display the Start menu	 (Windows key)
Move up, down, left, or right (for example, in a list or menu, or between buttons)	 ,  ,  ,  (arrow keys on the navigation pad)
Minimize all programs and display the desktop	 (Home key)
Turn the handheld on or off	 (Power key)

Starting and exiting the TerraSync software

To start TerraSync, do one of the following:

- Tap , tap Programs, and then tap TerraSync.
- On a Pocket PC, tap  and then tap the TerraSync icon on the recently-used programs list.
- On an H/PC 2000 or Windows PC, double-tap the TerraSync icon on the desktop.

While the software is loading, a Trimble identification screen appears. The software always opens at the Skyplot subsection of the Status section.

To exit TerraSync, tap the Close button  in the upper right corner of any TerraSync screen. You do not have to exit the TerraSync software before turning off the field computer.

To switch to TerraSync when it is already running, do one of the following:

- Use any of the methods described above for starting TerraSync.
- On a Pocket PC, tap  and then tap the TerraSync icon on the recently-used programs list.
- On an H/PC 2000 or Windows PC, tap the TerraSync icon in the system tray in the taskbar.

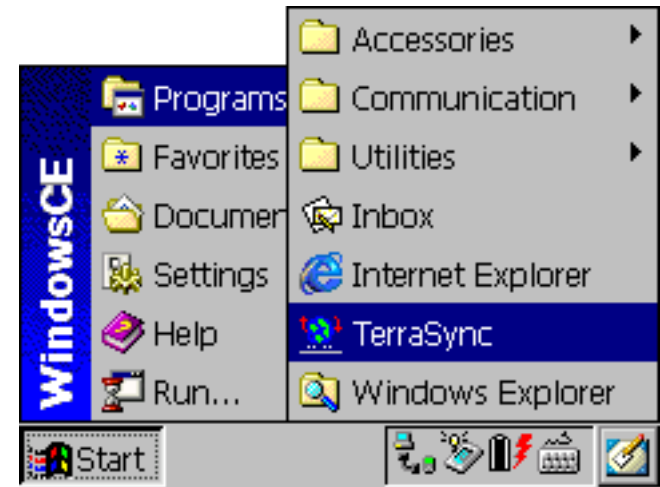



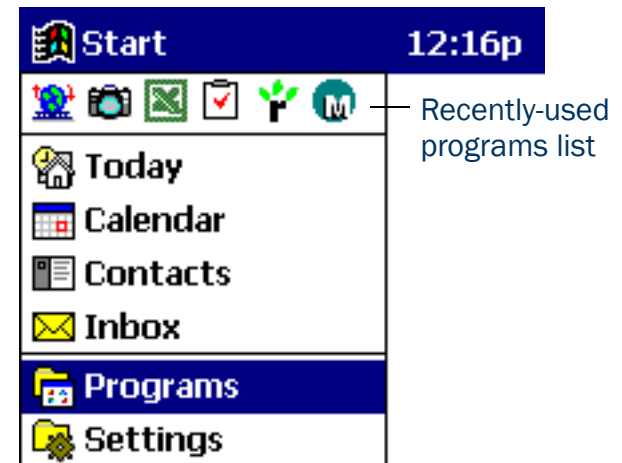

H/PC 2000

Pocket PC



Section structure

The TerraSync software is arranged in five *sections*:

Section	Function
 Map	View features, background files, and the GPS trail graphically.
 Data	Work with data files: <ul style="list-style-type: none">• create a new data file or open an existing data file• collect new features or maintain existing features• move, copy, delete, or rename data and background files
 Navigation	Navigate to features using the Direction Dial and Close-up screen.
 Status	View information about: <ul style="list-style-type: none">• the satellites the TerraSync software is tracking, their relative positions in the sky, and your current position• the GPS receiver and real-time correction source• the TerraSync software version and trademark information
 Setup	Configure the TerraSync software.

The TerraSync display

The screen below shows some of the features of the TerraSync software.

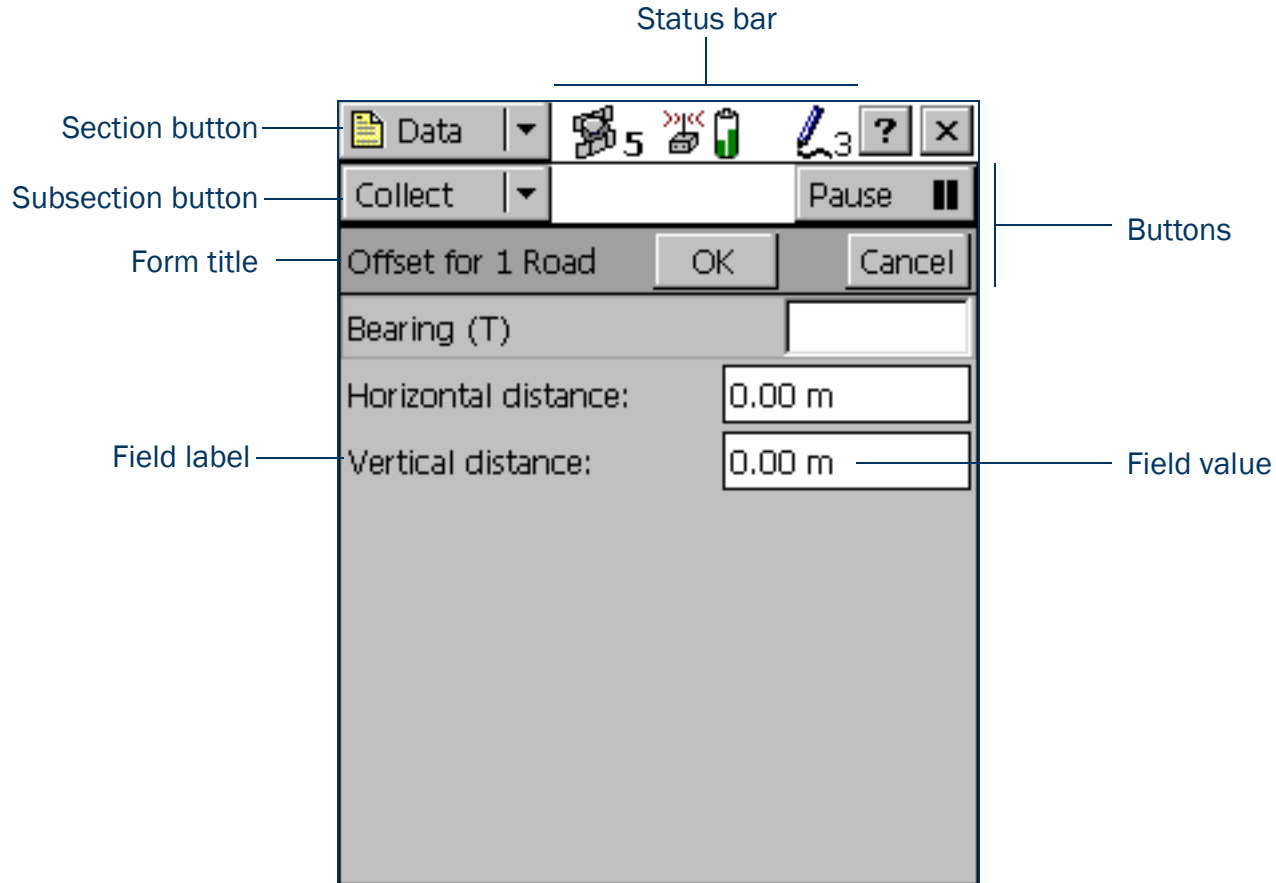



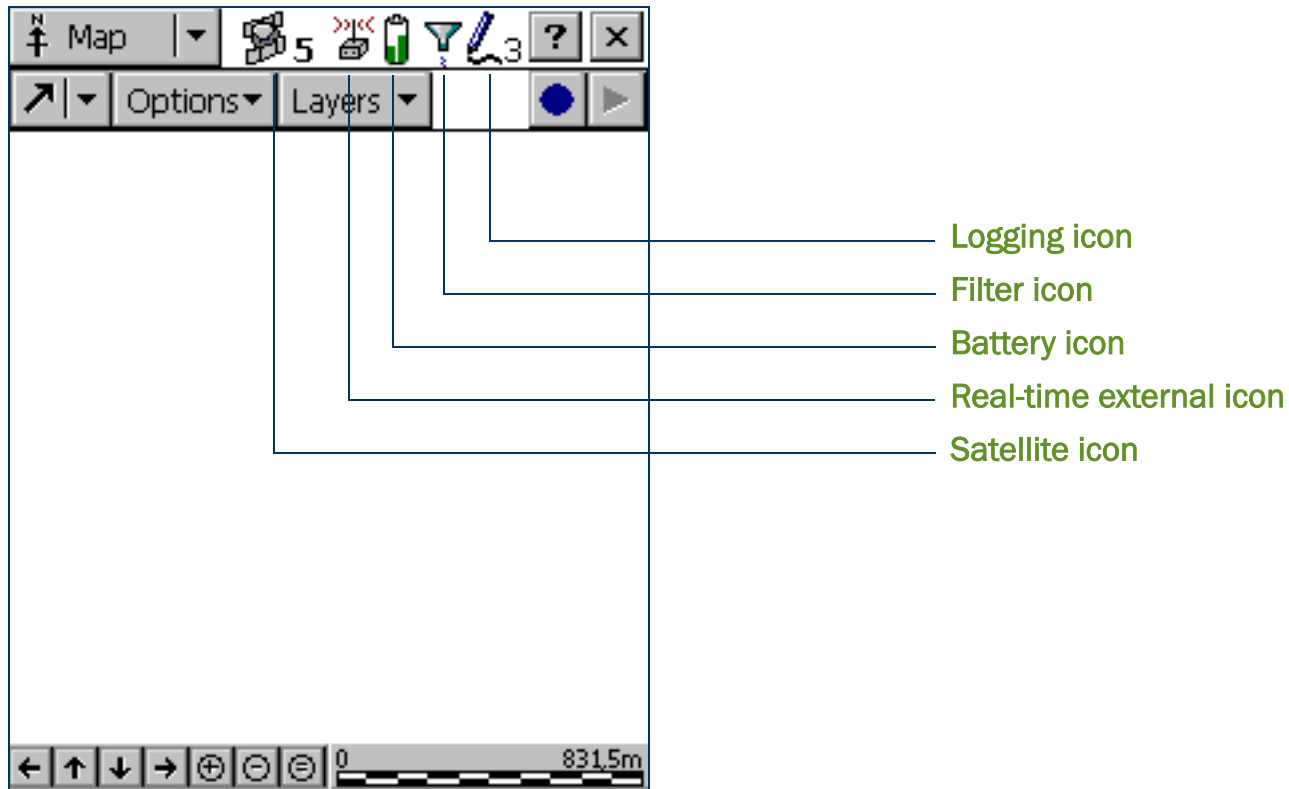

Status bar









The status bar provides basic information about the status of the TerraSync software. It appears in the top row of the TerraSync screen. It is always visible, but the icons displayed depend on the current status of the system.









Status bar: Icons

Icon	Name	Description
	Satellite icon	Shows whether the geometry of the satellites is good or bad, depending on the GPS configuration settings. The number below the icon indicates how many satellites are being used to compute GPS positions. The satellite icon flashes when the geometry of the satellites (their PDOP or HDOP) is poor. The number flashes when not enough satellites are available. You need at least four satellites to compute GPS positions.
	Satellite icon (carrier)	When you are logging carrier phase data, the satellite icon changes to show the carrier time, in minutes and seconds, for the current block of data.
	Satellite icon (RTK)	When you are logging positions using measurements from an RTK base station, the satellite icon changes to show the horizontal precision estimate for the current position. The estimate is displayed in centimeters or inches, depending on the distance units configured in the Units form .
	Connect icon	When the TerraSync software is trying to connect to a receiver, the connect icon appears instead of the satellite icon. If TerraSync cannot connect to the GPS receiver, the connect icon flashes.
	Antenna icon	If the TerraSync software connects to the receiver but cannot find a GPS antenna, the antenna icon appears instead of the satellite icon. This icon flashes to warn you that there is a problem.
		If no icon appears in this position, no GPS receiver is connected.





Status bar: Icons (Continued)

Icon	Name	Description
	Real-time external icon	Shows that TerraSync is receiving real-time corrections from an external source, such as a radio.
	Integrated RTK radio icon	Shows that TerraSync is receiving RTK corrections through the GPS receiver's integrated radio.
	External RTK icon	Shows that TerraSync is receiving RTK corrections through an external radio.
	Real-time VRS icon	Shows that TerraSync is receiving real-time DGPS corrections from a VRS server.
	RTK VRS icon	Shows that TerraSync is receiving RTK corrections from a VRS server.
	Real-time BoB icon	Shows that TerraSync is receiving real-time corrections from a Beacon-on-a-Belt (BoB) receiver.
	Real-time beacon icon	Shows that TerraSync is receiving real-time corrections from a beacon.
	Real-time satellite icon	Shows that TerraSync is receiving real-time corrections from a satellite differential service.
	Real-time WAAS icon	Shows that TerraSync is receiving real-time corrections from WAAS or EGNOS .
		If the real-time signal is lost, the current real-time icon flashes. If no icon is visible, the TerraSync software is using autonomous (uncorrected) GPS to calculate its position.

Status bar: Icons (Continued)

Icon	Name	Description
	Battery icon	<p>The left half of this icon indicates the charge level of the GPS receiver battery, if one is connected. The right half indicates the charge level of the field computer battery. When the battery is fully charged, the corresponding half of the battery icon appears green. The level of green is lower when the battery charge is lower. When the power level is low, the level in the icon is yellow. When the power level is critical, the level in the icon is red and the icon flashes.</p> <p>NOTE — A GeoExplorer CE series handheld is a combined GPS receiver and CE device, and both components use the same battery. When TerraSync is running on a GeoExplorer CE series handheld, both halves of the battery icon show the same level.</p>
	Filter icon	Indicates that a filter has been applied to the open data file. When this icon is not displayed, no filter has been set up. For more information, see Filtering features .
	Logging icon	Shows that the TerraSync software is logging GPS position information. The number to the right of the icon indicates the number of positions logged.
	Logging carrier icon	Shows that the TerraSync software is logging carrier phase GPS position information. The number to the right of the icon indicates the number of positions logged.
	Logging static icon	Shows that the TerraSync software is logging a point feature or vertex in static mode , which is available only when TerraSync is receiving RTK corrections. In static mode, only the GPS position with the best precision estimate is logged. All other positions are discarded. The number to the right of the icon indicates whether a position has been logged. If the required precision has not been achieved, the number is 0 and no position is logged. If a position with the required precision has been logged, the number is 1. If a position with a better precision is received, it replaces the previously logged position.
	Logging vertex icon	Shows that the TerraSync software is logging GPS position information for an averaged vertex. The number to the right of the icon indicates the number of positions logged for this vertex.

Status bar: Icons (Continued)

Icon	Name	Description
	Base logging icon	Shows that the TerraSync software is logging positions to a base data file, or that is generating correction messages.
	Digitizing icon	Shows that the TerraSync software is in Digitize mode and GPS logging is paused, so tapping the map will result in a digitized position being recorded for the open feature. The number to the right of the icon indicates the number of digitized positions logged for this feature.
	Pause icon	When logging is paused, the pause icon flashes.
	Memory icon	When storage space is low, the memory icon appears. If memory gets low while you are logging positions, the memory icon flashes alternately with the logging icon. If you are not logging, the memory icon appears alone and flashes.
		When no icon appears in this position, memory space is sufficient, and the TerraSync software is not logging position data.

Interacting with the TerraSync software

You can interact with the TerraSync software in a variety of ways.

The following topics describe the different types of displays:

- **Screens**
- **Graphical screens**
- **Forms**

TerraSync screens also have the following features:

- **Lists**
- **Buttons**
- **Data entry fields**
- **Auto-incrementing attributes**
- **Pop-up messages**
- **Sound**
- **Color**

The following topic describes additional ways of interacting with the software if the field computer has a keyboard:

- **Keyboard shortcuts**

Screens

Use screens to view information in a list or table, or to make selections that provide access to other areas in the software. A screen usually displays information that you cannot edit directly.

Most screens contain buttons, lists, or labels. When a screen contains a field, a default value is supplied in the field.

Examples of screens are:

- The top level screen for each subsection in the Data section, such as the New File screen and the File Manager screen
- The main screen of the Setup section

The screenshot shows a software interface with a top navigation bar containing 'Data', 'Manager', and 'Options' menus. Below the navigation bar are two dropdown menus: 'Choose File Type:' set to 'Data files' and 'Location:' set to 'Device'. The main area contains a table with three columns: 'Name', 'Start Time', and 'Size'. The table lists four files: R061115A (3 KB), R061219A (11 KB), Sample (56 KB), and Starfish (11 KB). The 'Starfish' row is highlighted in blue. At the bottom of the screen, there are two rows of status information: 'Features: 148' and 'Positions: 467' on the first line, and 'Status: Transferred' and 'DD: Seaview' on the second line.

Name	Start Time	Size
R061115A	06/11/03 03:03 pm	3 KB
R061219A	06/12/03 07:33 pm	11 KB
Sample	06/11/03 03:07 pm	56 KB
Starfish	06/12/03 08:26 pm	11 KB

Features: 148 Positions: 467
Status: Transferred DD: Seaview

Graphical screens

Use graphical screens to view information graphically. You cannot enter data in a graphical screen, and you cannot edit the information displayed.

Examples of graphical screens are:

- The Skyplot screen and Satellite Information screen in the Status section
- The Direction Dial and Close-up screens in the Navigation section
- The map display in the Map section

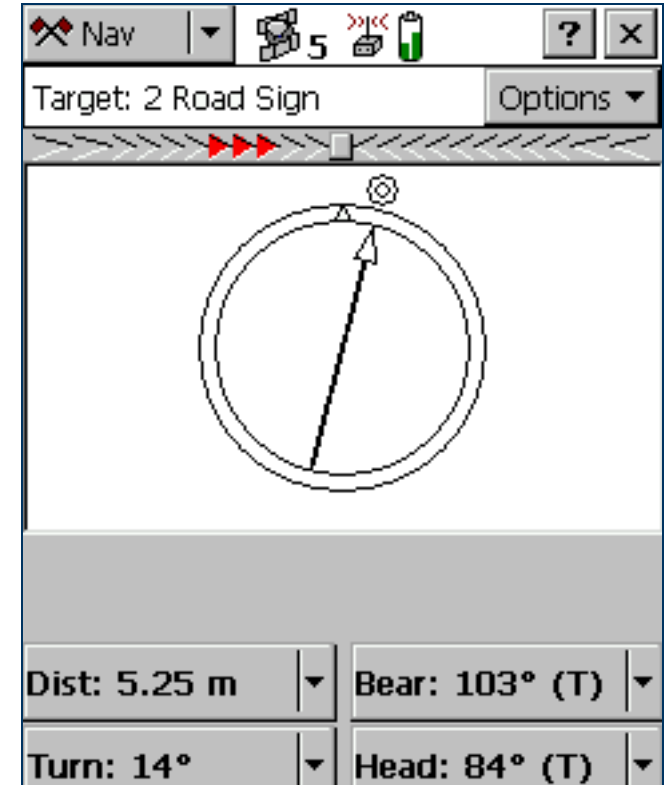

Forms

To enter data in the TerraSync software, you use a form. Like a paper form, a software form has a title and a sequence of lines or fields.

Each field on a form generally has two parts: a label (or name) and a value. A label is followed by a colon (:), which separates it from the value. Some fields are separator fields, which have no value and serve simply to divide a form into sections. If there is a dark rectangle around a field and its label, it is the current field on the form. Any editing operations apply to the current field.

To edit a field, select it. There are several ways to enter data into a form, depending on the keyboard options the field computer has, and the type of data stored in the field. For more information, see [Data entry fields](#).

To move to the next field on a form, do one of the following:

- Tap the field you want to move to.
- Tap Enter on the on-screen keyboard. Tap Enter repeatedly to cycle through all fields on the form.
- Press Tab on the physical keyboard. Press Tab repeatedly to cycle through all fields on the form.

To move up or down the form, drag the vertical scroll bar.

When you have finished browsing through the form, or have finished editing fields in the form, tap **OK** to accept the changes you have made and return to the previous screen.

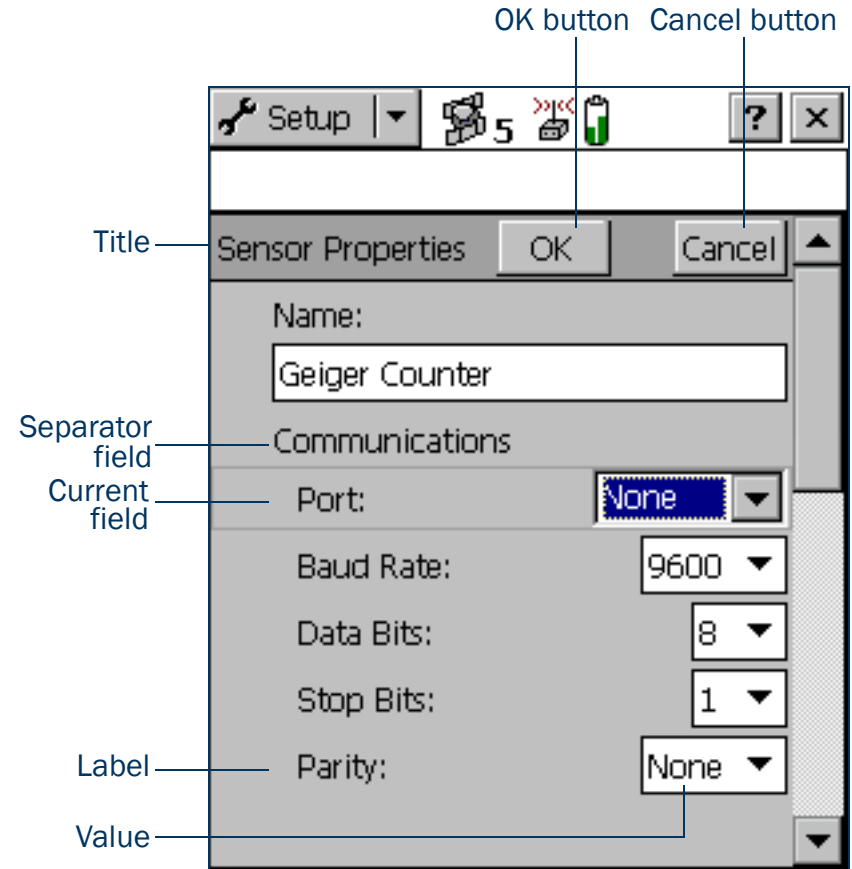

Lists

Some forms in the TerraSync software include *lists* for you to select data files or features from. A list contains the information that is currently stored.

Each row of the list represents one file or feature. Each column shows information about that item. A list also has a label that describes its contents.

The figure shows the Choose Feature list. This list displays all feature types in the open data file.

Often information fields are displayed at the bottom of the screen, below the list. They provide useful information about the item currently highlighted in the list.

To select an item from a list, highlight the item. If the item you want is not visible, drag the vertical scrollbar up or down until it is visible.

You can tap a column heading to sort by that column. For example, to sort the Choose Feature list by feature name, tap the Name column heading.

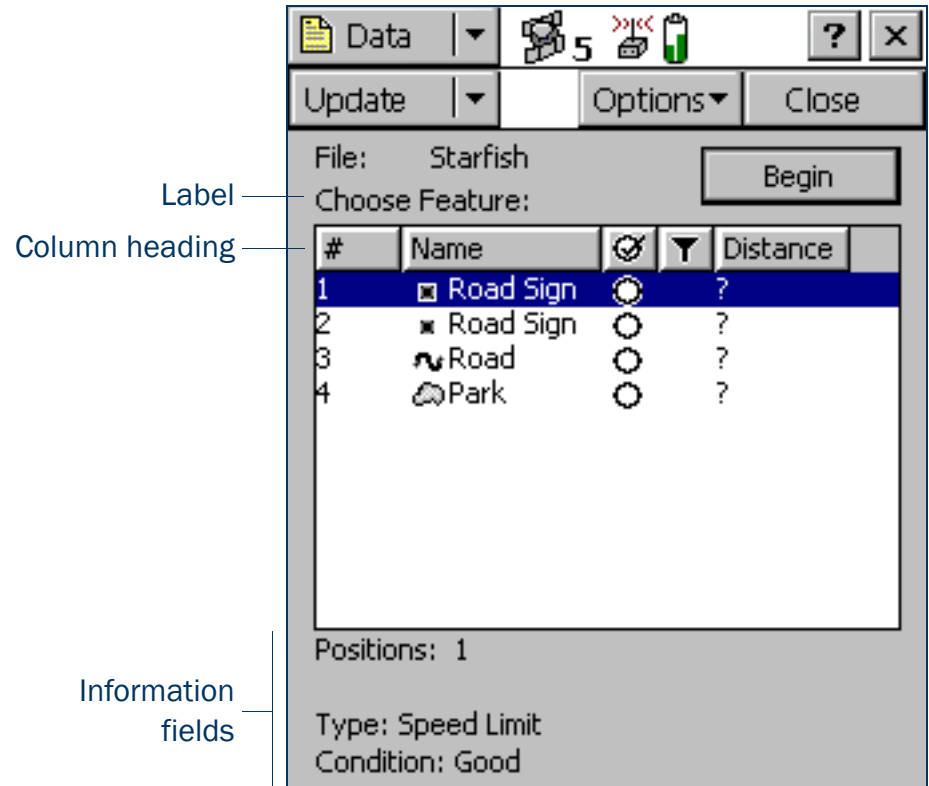

TIP – If the list is already sorted by the column you tapped, tapping the column heading reverses the sort order.

Buttons

Many forms and screens in the TerraSync software contain buttons. When you tap a button, the TerraSync software carries out the appropriate command or opens a new screen. For example, if you tap **GPS Settings** in the Setup screen, the GPS Settings form appears.

List buttons and menu buttons are special buttons. They can be identified by the drop-down arrow at the right end of the button. When you tap one of these buttons, a drop-down list of commands appears. For more information, see [List buttons](#) and [Menu buttons](#).

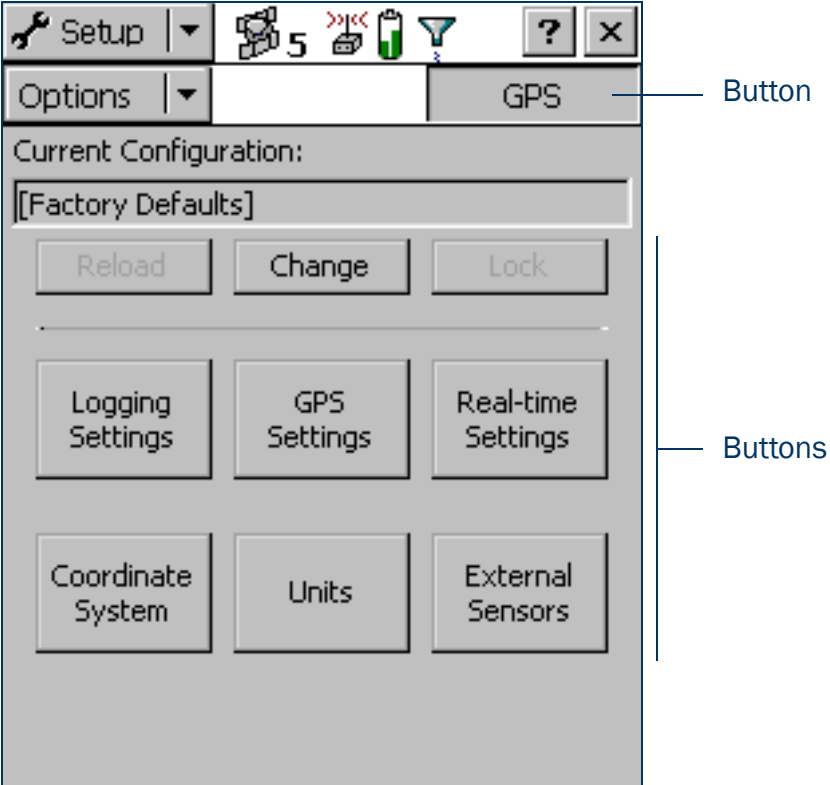

List buttons

List buttons are **Buttons** that have a vertical line and a drop-down arrow at the right end of the button.

Use list buttons to move to a different section or subsection of the software, or to change the mode in the current section.

When you tap a list button, a drop-down list appears. Select an option on the list to select the command it describes. The label of the list button changes to match the option you selected.

The following list buttons appear in the TerraSync software:

- Section button
- Mini Section button (appears when the software is arranged in **Panes**)
- Subsection button
- Map Tools button in the **Map section**
- Status Mode button in the **Status section**

NOTE — List buttons differ from *menu* buttons (such as Options buttons) in their appearance, behavior, and function. For more information, see **Menu buttons**.

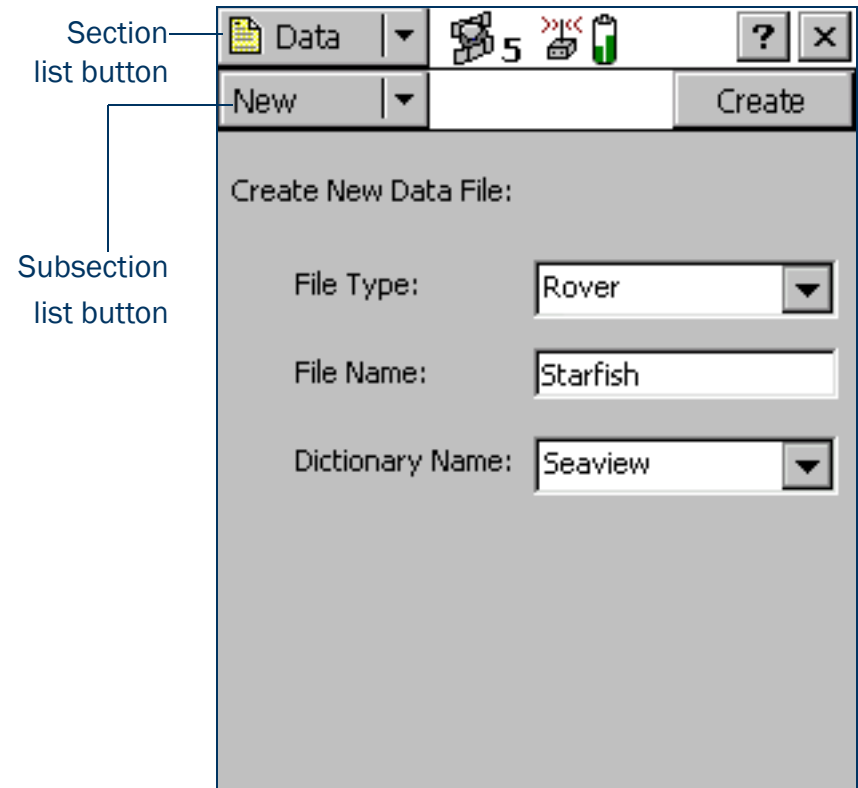

Menu buttons

Menu buttons are **Buttons** that have a drop-down arrow at the right end of the button.

Use menu buttons to access additional functionality and commands. When you tap a menu button, a drop-down list appears. Select an option on the list to select the command it describes.

Unlike a list button, a menu button's label does not change when you select a command from the list.

The following menu buttons appear in the TerraSync software:

- Any **Options** button
- The **Layers** button in the Map section
- The **Edit** button in the Data section's **Edit dictionary form**

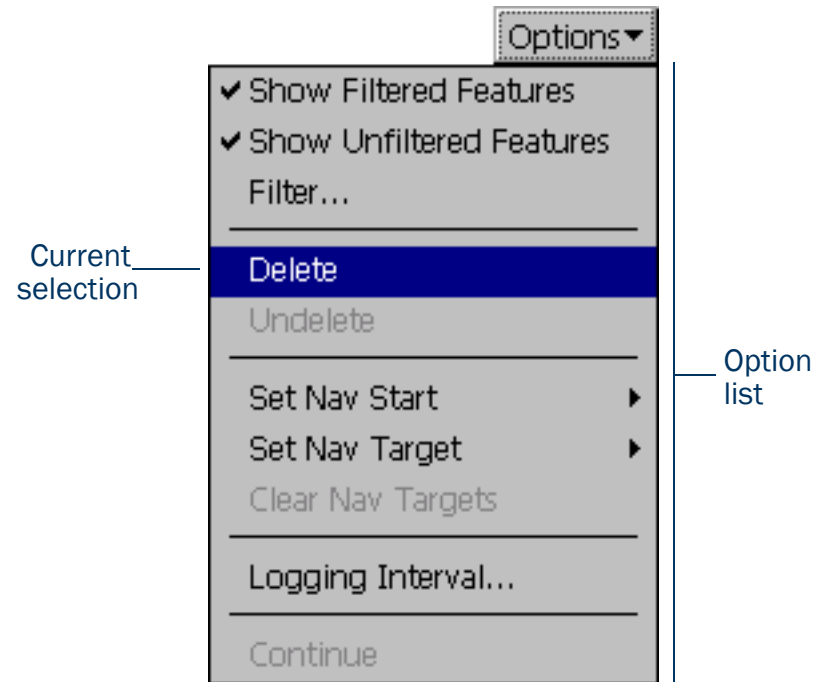

NOTE — Menu buttons differ from *list* buttons (such as the Section list button) in their appearance, behavior, and function. For more information, see **List buttons**.

Keyboard shortcuts

If you are using a field computer that has a keyboard, such as a notebook computer or a TSCe field device, you can use keyboard shortcuts instead of the touch screen.

To use a keyboard shortcut, hold down the **Alt** key on the keyboard and press the letter assigned to the shortcut. For example, the shortcut letter for switching to the Map section is M, so you can press **Alt+M** to switch to the Map section.

There are two types of shortcuts in the TerraSync software: global and local shortcuts.

Global shortcuts apply wherever you are in the software. They let you perform important actions such as switching quickly between the sections of the software. If you use the shortcut for the current section or subsection, the corresponding list drops down. For example, if you press **Alt+M** when the Map section is already open, the Section list drops down.

You can also use global shortcuts to close the current file, exit the software, or control data logging from any section or screen of the software.

NOTE — Global shortcuts do not apply when the Data Dictionary Editor is open.

Local shortcuts apply only within the current form or screen. They open lists such as the Options list or subsection list, or run commands on the open list.

The same local shortcut letter may be used in different screens to perform different tasks. For example, if you press **D** when the Setup section's Option list is open, TerraSync disconnects from the GPS receiver. However, if you press **D** in the File Manager subsection's Option list, TerraSync deletes the selected file.

If the field computer's screen size is 640 × 240 pixels or larger, the screen is arranged in panes. Local shortcuts work only for the primary pane (the pane in the top left of the screen).

The following table lists the global shortcuts in the TerraSync software:

Action	Keyboard shortcut
Open Map section	Alt+M
Open Data section	Alt+D
Open Navigation section	Alt+N
Open Status section	Alt+S
Open Setup section	Alt+E
Open Skyplot screen	Alt+K
Open New File subsection	Alt+T
Open Collect Features subsection	Alt+T
Open Update Features subsection	Alt+U
Start, pause, or resume logging GPS	Alt+L
Close current data file	Alt+C
Exit TerraSync	Alt+Q

The following table lists the local shortcuts in the TerraSync software:

Action	Section	Keyboard shortcut
Select a command on an open list	All sections	Underlined letter
Open the Options list for the current screen	All sections	Alt + O
Open the Layers list	Map	Alt + A
Zoom in	Map	Alt + Z
Zoom out	Map	Alt + Y
Zoom extents	Map	Alt + X
Move up	Map	Alt +up arrow key; Alt + 8
Move down	Map	Alt +down arrow key; Alt + 2
Move left	Map	Alt +left arrow key; Alt + 4
Move right	Map	Alt +right arrow key; Alt + 6
Open Existing File subsection	Data	Alt + X
Open File Manager subsection	Data	Alt + G
Open Skyplot subsection	Status	Alt + K
Open Satellite Info subsection	Status	Alt + F
Open Receiver subsection	Status	Alt + V
Open Real-time subsection	Status	Alt + A
Open Plan subsection	Status	Alt + P
Open Sensor subsection	Status	Alt + R
Open Comms subsection	Status	Alt + O
Open UTC Time subsection	Status	Alt + I
Open About subsection	Status	Alt + B

Data entry fields

The method you use to enter data in a field on a form depends on the type of field you are entering data into, and on the availability of keyboards.

The following types of field can appear:

- **Text fields**
- **Numeric fields**
- **Menu fields**
- **Time fields**
- **Date fields**
- **Filename fields**

If the field computer has a physical keyboard, you can use it to enter text or numbers, just as you would in any Windows program. If you do not have a keyboard, you can use on-screen keyboards for data entry. An on-screen keyboard is a small dialog that pops up from the taskbar when you select a field that allows data entry. You can also manually activate an on-screen keyboard at any time.

Use the on-screen keyboard to specify the text or number you want to enter. As you enter characters, they appear in the selected field. An on-screen keyboard may provide “keys” for you to tap, or may accept handwriting which it interprets as text.

If you use an on-screen keyboard to enter values, the TerraSync software automatically moves the focus to the next field on the form. To cycle through the fields on a form, repeatedly tap Enter on the on-screen keyboard. If the field computer has a physical keyboard, press the Tab key to cycle through the fields. When you reach the end of the form, the focus moves to the first field on the form.

For more information, see [On-screen keyboards](#).

Text fields

To enter a value in a text field, use an on-screen keyboard or the physical keyboard. If you are using a field computer with on-screen keyboards, a keyboard pops up automatically when you select a text field. The keyboard that pops up is the one that was selected when you started the TerraSync software. For information on changing the selected keyboard, see [On-screen keyboards](#).

Numeric fields

To enter a value in a numeric field, use an on-screen or physical keyboard. If the field computer uses on-screen keyboards, the [Trimble numeric keyboard](#) pops up when you select a numeric field.

TIP — Any text or numeric field can be defined as an auto-incrementing attribute. For more information, see [Auto-incrementing attributes](#).

Menu fields

A menu field has a predefined list of values associated with it. To change the selected value, tap the drop-down arrow at the right of the field and select an option from the list.

The current value in a drop-down list is highlighted. To choose a different value, select the value from the list. If a drop-down list has more options than fit on one

screen, a scroll bar appears on the right. Drag the scroll bar or tap the arrow buttons to scroll up and down the list. Some menu fields can store either a value you enter or a value you select from a list. For example, in the Data form in the Setup section, the Interval field can accept either an integer between 1 and 999, or Off. The field lets you enter a value manually using an on-screen or physical keyboard, but also includes a drop-down list of values.

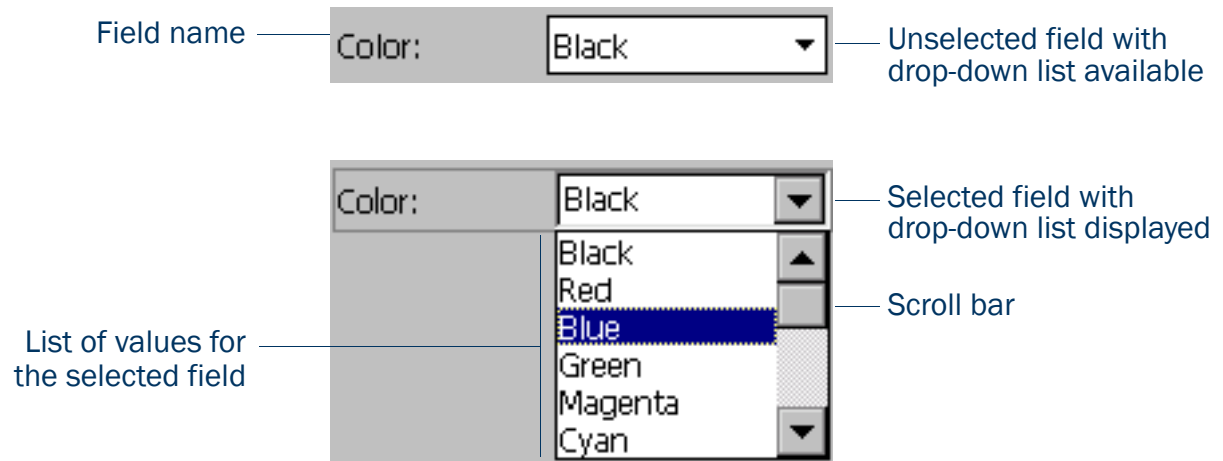

Time fields

You can enter time values manually using an on-screen or physical keyboard, or you can select the current time from a drop-down list. If the field computer uses on-screen keyboards, the **Trimble numeric keyboard** pops up when you select a time field.

To enter the current time, tap the arrow at the right of the field and select Now from the drop-down list.

In the data dictionary, you can specify that a time attribute be automatically set to the current time when the feature is created, when the feature is updated, or both.

Date fields

You can enter a date value manually using the physical keyboard, or by selecting it from the drop-down calendar.

To enter a date manually, type it in from the keyboard. To select it from the calendar, tap the drop-down arrow at the right of the date field and select the date you require from the calendar.

In the data dictionary, you can specify that a date attribute be automatically set to the current date when the feature is created, when the feature is updated, or both.

Filename fields

A filename field lets you attach an existing file to a feature.

The TerraSync software does not record attached files. Use other software or hardware, such as a digital camera or sound recorder, to create and save files before you attach them to features.

You can enter a filename manually using the physical keyboard, or you can select the filename from the drop-down list for the filename field.

The drop-down list shows files in the current working folder. To change the working folder, tap the Browse button  to the right of the filename field. In the pop-up window that appears, navigate to the folder you need.

TIP — If you set the working folder to the folder where the files to be attached are stored, you can simply select the appropriate file for each feature from the drop-down list, without having to check or change the working folder each time.

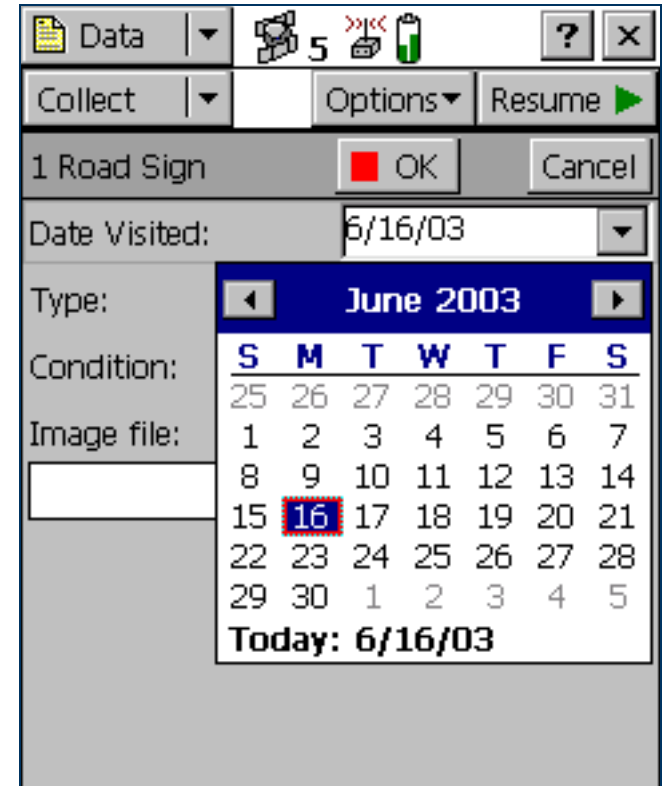

To view the currently selected file, tap the Preview button  beside the attribute field. The file is opened in the default program associated with its file type.

Once you attach a file to a filename attribute in a feature and save the feature, the selected file is moved to the TerraSync data folder and assigned a unique name. If you open the feature for review later, the actual filename is not displayed, because the file has been renamed. Instead, a message based on the file type appears. For example, if you attached the file Elm024.jpg to a feature, the text **Attached JPG File** appears in the attribute field.

When you transfer the data file to the office computer using the Trimble Data Transfer utility, any attached files are transferred with the data file, and are stored with the transferred data file. This link is also maintained when you export the data file to a GIS. For more information, refer to the GPS Pathfinder Office Help.

TIP – Sometimes, to save space or to create better quality files, recording software on a CE device (such as sound recording software that creates .wav files) uses a default file format that is unreadable on a desktop computer. Before going out into the field, test that you can transfer and read files created by the software that you want to use. If necessary, change the recording software's settings to use a format that is compatible with the desktop computer.

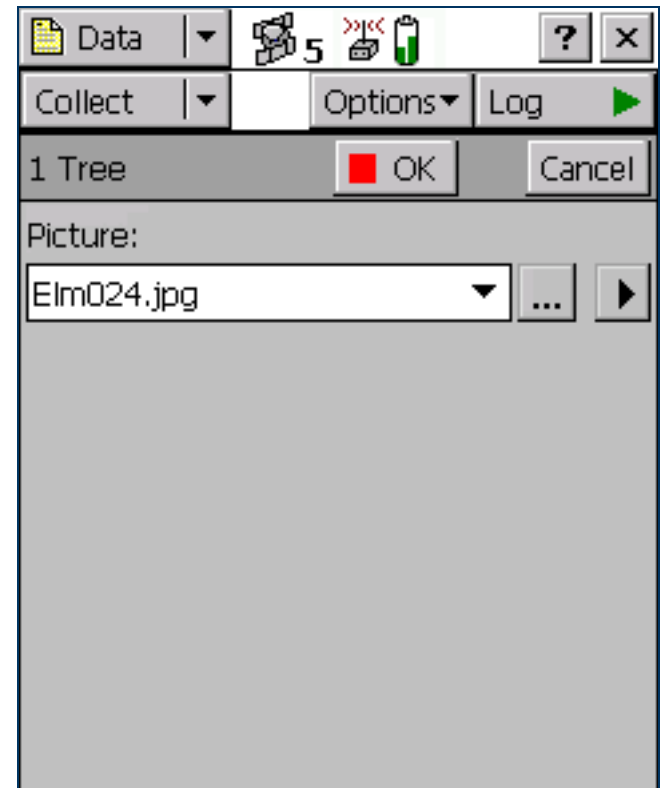

Auto-incrementing attributes

Any numeric or text attribute can be defined as an auto-incrementing attribute. When you create a new feature, the TerraSync software automatically fills in each auto-incrementing attribute with a default value. This value is the next value in the auto-incrementing sequence, is based on the step value you specified in the data dictionary and the last value entered in the field. The sequence can increase or decrease, and may advance in any increment (step) value, provided this value is within the acceptable range for the attribute.

Although you can define a text attribute as an auto-incrementing attribute, only numeric values within the text are incremented or decremented. For example, if the last value you entered was 47A, and the step value is 1, the next value generated by the TerraSync software is 48A. However, if the last value was AAA, the next is still AAA, as there is no numeric component to increment.

When the text consists of more than one number interspersed with alphabetic characters, only the last number is incremented. For example, if the step value is 1, and the last value was A100-K9, the next value is A100-K10.

The auto-incremented value is only a default value, so you can edit it if you want. If you do, the next value in the sequence is calculated using the new value you entered, not the original value generated by TerraSync.

If TerraSync cannot generate the next value in the sequence, it creates the attribute without a value. This occurs if:

- the feature is the first of its type to be created in this file and no default value is specified
- the last value for the attribute was blank
- the last value was the maximum value in the range and the sequence is incrementing
- the last value was the minimum value in the range and the sequence is decrementing

To make an attribute auto-incrementing, you must set an increment value in the data dictionary. You can do this in the Data Dictionary Editor utility in the GPS Pathfinder Office software, or in the Data section's **File Manager screen**. For more information on making an attribute auto-incrementing, refer to the Data Dictionary Editor Help.

Pop-up messages

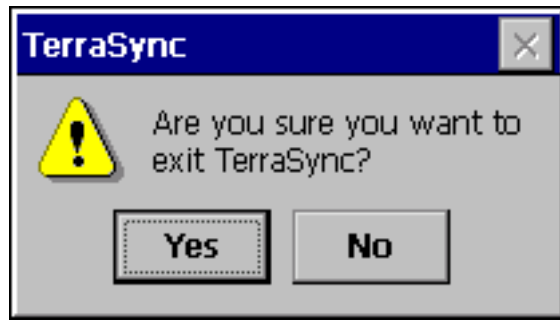

When the TerraSync software asks a question, it displays a pop-up message. You must answer the question before you can continue working with TerraSync. To answer the question, tap one of the buttons on the message box. The pop-up message disappears.

Error messages are examples of pop-up messages. **Warning** and **Error** messages should be noted, because they contain important information about the task you are trying to perform.

Tooltips

A tooltip is a yellow message box that contains information about an item on the screen, or about the current system status. Tooltips appear:

- when you tap on an icon in the status bar
- as transient messages in the status bar
- when you tap on an item on the map
- when you measure distances and areas on the map

To close a tooltip, tap it, or tap anywhere else on the screen.

If you tap any icon in the **Status bar**, a tooltip appears over it. The tooltip contains information about the current state of the system function the icon represents. For example, if you tap the **Filter icon** when a filter is in use, a tooltip appears, showing the message **Filter is applied**.

A transient message shows information that is only important for a few seconds, such as notification that you have successfully recorded an offset with a laser rangefinder, or that the feature has been stored. A tooltip that contains a transient message appears over the status bar for three seconds, or until you tap the tooltip. Other functions in the software are not affected by transient messages.

In the **Map section**, you can tap on any item to display its **Position information** in a tooltip. When you use the **Measure tool** in the map, **Measurement information** appears in a tooltip in the top left corner of the map display.

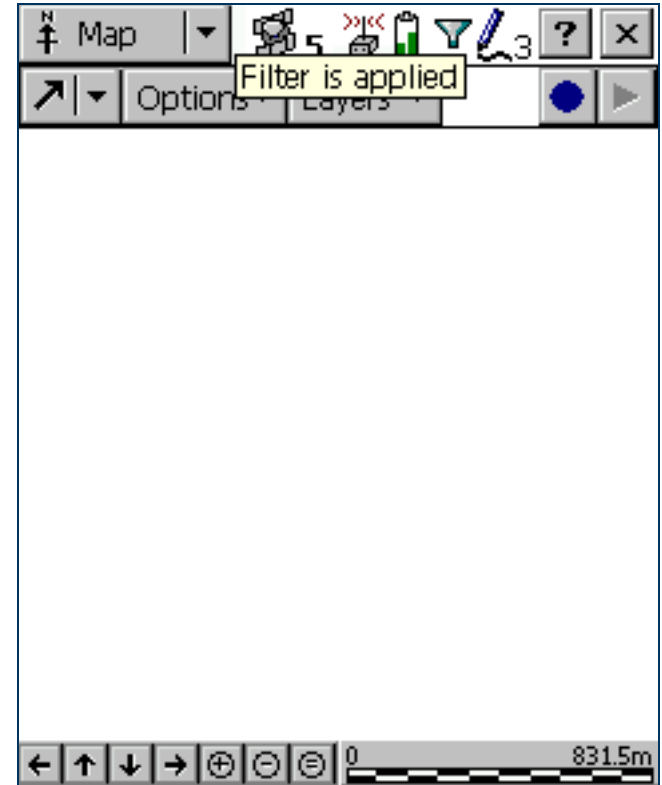

Sound

The TerraSync software uses sound to indicate special conditions or events. Often these conditions are accompanied by a change in a status icon. For example, when the battery on the GPS receiver gets low, the battery icon in the **Status bar** flashes, and the **Low GPS battery** sound is played.

The events and conditions that can occur fall into three categories:

Category	Description
Success	An operation has been successfully completed, or a warning condition has been resolved. By default, a success event uses a sound with rising tones.
System	A message box, containing a question or information about an error that has occurred, has appeared. You must acknowledge the message, by tapping a button in the message box, before you can continue working with the TerraSync software.
Warning	A condition exists that could cause loss of data, or could prevent you from collecting data successfully. By default, a warning is indicated by a sound with falling tones.

The following table lists events and conditions in the TerraSync software, and the sounds that are used for them:

Name	Category	Description
Feature stored	Success	The feature has been successfully stored.
GPS connected	Success	The TerraSync software has successfully connected to the GPS receiver and is receiving position information.
GPS OK	Success	The GPS quality has increased to the levels you have specified, and the TerraSync software is logging positions again.
Minimum positions stored	Success	The TerraSync software has logged the minimum number of positions for the current feature. You can now safely close this feature and begin logging another feature.

Name	Category	Description
Navigation proximity alarm	Success	The navigation target is within the close-up range you have specified, and the Direction Dial screen changes to the Close-up screen.
Position logged	Success	The TerraSync software has successfully logged a GPS position.
Real time OK	Success	The connection to the specified source of real-time differential correction has been regained.
General error	System	An error has occurred. An error is indicated by the sound the field computer uses for the Critical Stop event.
Question	System	The TerraSync software requires some information or a decision from you. The question appears in a message box and is indicated by the sound the field computer uses for the Question event.
Dead GPS battery	Warning	The battery in use by the GPS receiver is dead. The TerraSync software continues to operate but no position information is received until the battery is replaced.
Low GPS battery	Warning	This sound plays repeatedly and the battery icon in the status bar flashes when the battery in use by the GPS receiver is running low and needs to be replaced.
Poor geometry	Warning	GPS position quality has dropped below the level you have specified because the visible satellites are too close together in the sky. The TerraSync software has paused logging until geometry improves.
Real time lost	Warning	The connection to the specified source of real-time differential correction has been lost.
Too few satellites	Warning	GPS position quality has dropped below the level you have specified because there are not enough visible satellites. The TerraSync software has paused logging until more satellites become visible.

Customizing sounds

The TerraSync software is supplied with default sounds for all warning and success events. However, you can customize these sounds or disable any or all of the sounds played by the software.

To enable or disable all sounds as a group:

1. Tap  .
2. Do one of the following:
 - On a Pocket PC, select Settings / Volume and Sounds.
 - On an H/PC 2000, select Settings / Control Panel / Volume and Sounds.
3. In the Enable sounds for group, select or clear the Applications check box to enable or disable warning and success sounds.
4. Select or clear the Events check box to enable or disable sounds for questions and error messages in the TerraSync software.

TIP — All the sounds used in the TerraSync software are wave (.wav) files. A default .wav file is supplied for each warning or success event that occurs in the software. You can change any of the sounds used by simply replacing the appropriate .wav file in the Windows folder on the field computer. To disable a sound, delete or rename its .wav file.

The events and their corresponding .wav files are as follows:

Event	Sound file
Feature stored	FeatureStored.wav
Dead GPS battery	GPSPatteryIsDead.wav
Low GPS battery	GPSPatteryIsLow.wav
GPS connected	GPSIsConnected.wav
GPS OK	GPSIsOK.wav
Poor geometry	PoorGeometry.wav
Position logged	PositionLogged.wav
Real time lost	RealTimeIsLost.wav
Real time OK	RealTimeIsOK.wav
Minimum positions stored	MinimumPositionsStored.wav
Navigation proximity alarm	CloseUpChange.wav
Too Few Satellites	TooFewSatellites.wav
Question	The file that the field computer uses for the Question event. By default, this is Question.wav. Use the Volume and Sounds system setting to replace the sound for this event.
General error	The file that the field computer uses for the Critical Stop event. By default, this is Critical.wav. Use the Volume and Sounds system setting to replace the sound for this event.

Color

The TerraSync software uses color to make it easier for you to distinguish important information, and to distinguish between similar items. Color is always used in conjunction with at least one other feature such as a sound, icon, or bold text, so information is not lost if the screen uses grayscale.

The following features of the TerraSync software use color to provide extra information or to clarify the display:

- **Map layer colors**
- **Battery icon**

NOTE — If the field computer has a grayscale display, the color information described in this section does not apply, and all items on screen appear in shades of gray. The default color scheme used in the TerraSync software has been selected to provide the best visibility on a color screen. To distinguish between items on a grayscale field computer, you may need to change the color scheme.

Map layer colors

The information displayed in the Map section is arranged in five layers. To make the map display clearer, you can select a different color for each of these **Map layers**. If a layer contains features, you can either use the feature colors assigned in the data dictionary, or set a single color for all features in the layer.

To select layer colors, tap **Layers** in the Map graphical screen and select Layer Formatting. The **Layer Formatting form** appears. You can set each layer to display in a different color. You can also set two or more layers to the same color.

Map section

- Icons
- Buttons
- Options
- Tools
- Layer options

To open the Map section, tap the Section list button and select Map.

The Map section is a graphical display of the features in the open data file. It can also display a background image, GPS information, and navigation information.

The color of an item on the map depends on which of the **Map layers** it belongs to.







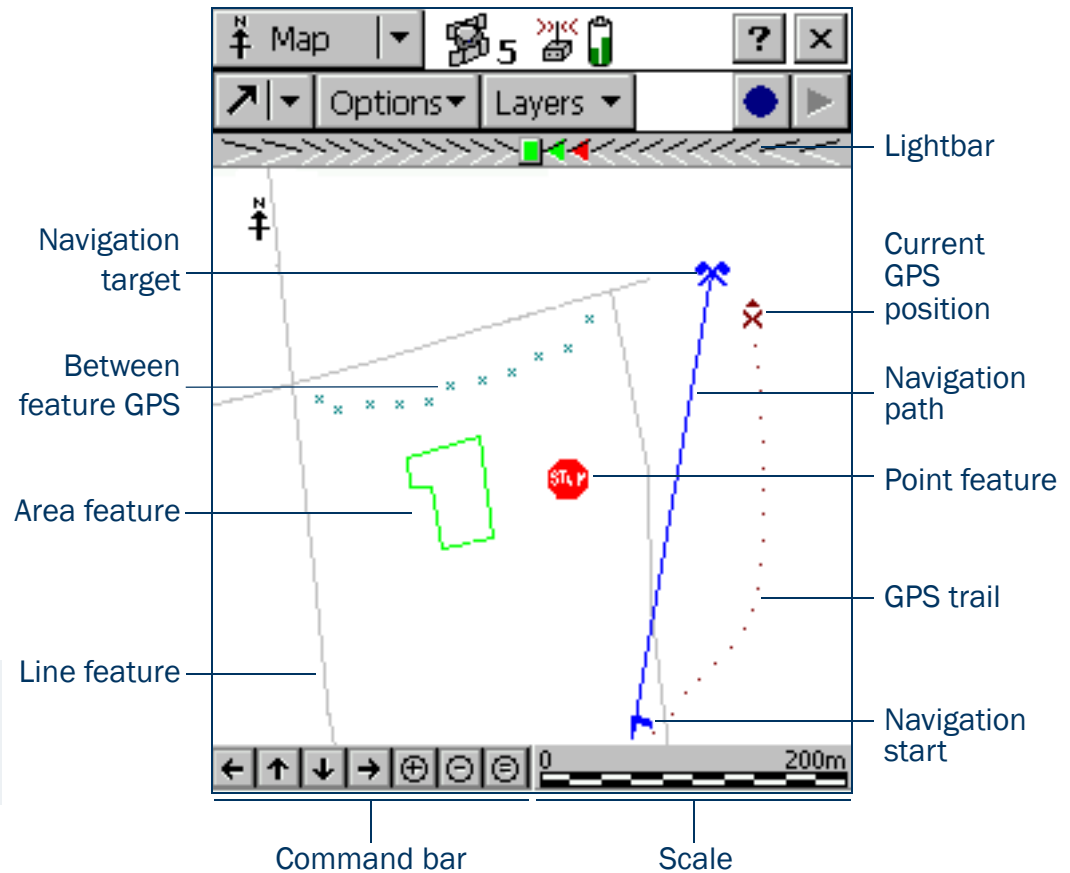

Use the **Map tools** to change the map scale and position, and to perform special functions such as digitizing positions and measuring between points.

For more information about the functions of the Map section, see **Using the Map section**.





NOTE — In the **TerraSync Standard edition software** you cannot display background images or imported data files.







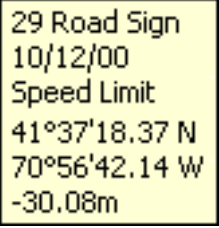

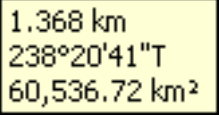

Map section: Icons

Item	Name	Description
	Lightbar	The lightbar uses colored icons to simulate the colored LEDs of a physical lightbar. The lightbar graphically guides you along the cross-track line , which is the shortest path between the navigation start and target. For more information, see Lightbar .
	North arrow	An arrow indicating the direction of north relative to the map display. The map is always oriented so that north is at the top of the screen.
	GPS trail	A trail of dots that shows the path you have taken recently. The GPS trail shows the last 60 GPS positions calculated by the receiver.
	Current position	The current GPS position, marked by the GPS cursor X , and your heading, shown by the heading arrow ▶ . If you are traveling too slowly or are stationary, only the GPS cursor is displayed.
	Reference position	The reference position for the base data file that is being collected. This icon only appears if a base data file is open.
	Map point	A point that you have selected from the map which is not part of a feature. When you tap a map point, a tooltip showing its Position information appears.
	Navigation start	An icon indicating the feature or point that is currently selected as the start for navigation. When a start and a target are selected, they are joined by a line to show the most direct path from start to target. You can use the Map section or the Navigation section to navigate from the start to the navigation target.
	Navigation target	An icon indicating the feature or point that is currently selected as the target for navigation. When a target is selected, you can use the Map section or the Navigation section to navigate to its location.







Map section: Icons (Continued)

Item	Name	Description
	Bearing to go arrow	An outlined arrow on the edge of the map, showing the approximate direction to the navigation target when it is not in the visible part of the map.
	Features	<p>Features you have logged in the current data file. Each feature type appears using the point feature symbol or line thickness defined in the data dictionary. A feature's color is determined either in the data dictionary or by the color of the layer it appears in.</p> <p>When a feature is selected on the map, it is highlighted and its position information appears. A selected point feature is outlined, and a selected line or area feature is displayed with a bold line.</p>
	Between feature GPS	A trail of small crosses that show all GPS positions logged but not associated with a feature.
	Position information	A tooltip showing the coordinates of the current map cursor location. If the selected location is a feature, the feature name and number also appear, as well the two attribute values from the feature that have been specified in the data dictionary as labels.
	Digitized position	The last point that you digitized for the open feature.
	Measured point	The last point that you measured.
	Measurement information	A tooltip showing the total length of the current measurement, the bearing from the start of the measurement to the last measured point, and the area enclosed by the measurement, if the measurement has been ended.



Map section: Icons (Continued)

Item	Name	Description
	Command bar	<p>A toolbar containing zooming and panning controls:</p> <ul style="list-style-type: none">  Pan half the map width to the left  Pan half the map height upwards  Pan half the map height downwards  Pan half the map width to the right  Zoom in  Zoom out  Zoom to extents to show all positions in all visible layers
	Scale	The scale at which the map is drawn. As you zoom in or out, the scale changes accordingly.

Map section: Buttons

Button	Function
 Map Tools	Opens the map tool list. For more information, see Map tools .
 Options	Opens the option list for the map. For a detailed list of the available options, see Options .
 Layers	Opens the layer option list for the map. For more information, see Map layers .
 Create Feature	Lets you start a new feature without returning to the Data section. For more information, see Creating and ending features from the Map section .
 End Feature	Lets you close the open feature without returning to the Data section. For more information, see Creating and ending features from the Map section .
 Undo	Deletes the last digitized position recorded for the current feature. For more information, see Digitizing .

Map section: Buttons (Continued)

Button	Function
 Log/Resume	Starts GPS position logging for the current feature, or resumes logging if logging is paused. For more information, see Controlling logging from the Map section .
 Pause	Pauses GPS position logging for the current feature. For more information, see Controlling logging from the Map section .
 End Measurement	Ends the current measurement. For more information, see Measuring .

Map section: Options

Option	Description
Zoom Extents	Changes the scale so that all selected layers are visible on the Map screen. The Zoom extents option varies. What it shows depends on what layers are selected and whether the features are filtered. If nothing is displayed on the Map screen, the Zoom extents option does not affect the map scale.
Auto Pan to GPS Position	Makes sure that the current GPS position is always visible. When this option is selected, and the GPS position is off screen or close to the edge of the screen, the TerraSync software automatically pans to bring the GPS position to the center of the screen. When the Auto Pan to GPS Position option is active, a bullet appears beside it. NOTE — You can select either Auto Pan to GPS Position or Auto Pan to Selection, but not both. To clear Auto Pan to GPS Position, select it again, or select Auto Pan to Selection.
Auto Pan to Selection	Makes sure that the currently selected feature is always visible. When this option is selected, and the currently selected feature is off screen or close to the edge of the screen, TerraSync automatically pans to bring the selected feature to the center of the screen. When the Auto Pan to Selection option is active, a bullet appears beside it. NOTE — You can select either Auto Pan to Selection or Auto Pan to GPS Position, but not both. To clear Auto Pan to Selection, select it again, or select Auto Pan to GPS Position.

Map section: Options (Continued)

Option	Description
Filter	Opens the Data section's Filter By form , where you can set or change filtering criteria.
Update Selected Feature	Opens the Data section's Attribute entry form for the currently selected feature, where you can update the feature's attributes or position. When you save the changes to the feature and close the attribute entry form, you are returned to the Map section. TIP — You can also open a feature for update by double-tapping it on the map.
Delete Selected Feature	Deletes the currently selected feature. This is the same as the Delete option in the Data section's Update Features screen . NOTE — Deleted features are never displayed in the map. Once you have deleted a feature, it is hidden on the map. You can only undelete a feature in the Update Features screen .
Set Nav Start	Defines the position of the navigation start. For more information, see Setting and clearing the navigation start and target .
Set Nav Target	Defines the position of the navigation target. For more information, see Setting and clearing the navigation start and target .
Clear Nav Targets	Clears the current navigation start and target. You do not have to select either the start or target before clearing them.
Cross-Track Light Bar	Hides or displays the navigation lightbar at the top of the Map screen. By default, the lightbar is hidden. For more information, see Lightbar .
Enter Coordinates	Opens the Enter Coordinates form , where you can record a position for the open feature by entering its coordinates manually. For more information, see Creating manual positions . NOTE — To enter coordinates manually, you must be in Digitize mode with a feature open.
Refresh	Clears the map display and then redraws it.

Map tools





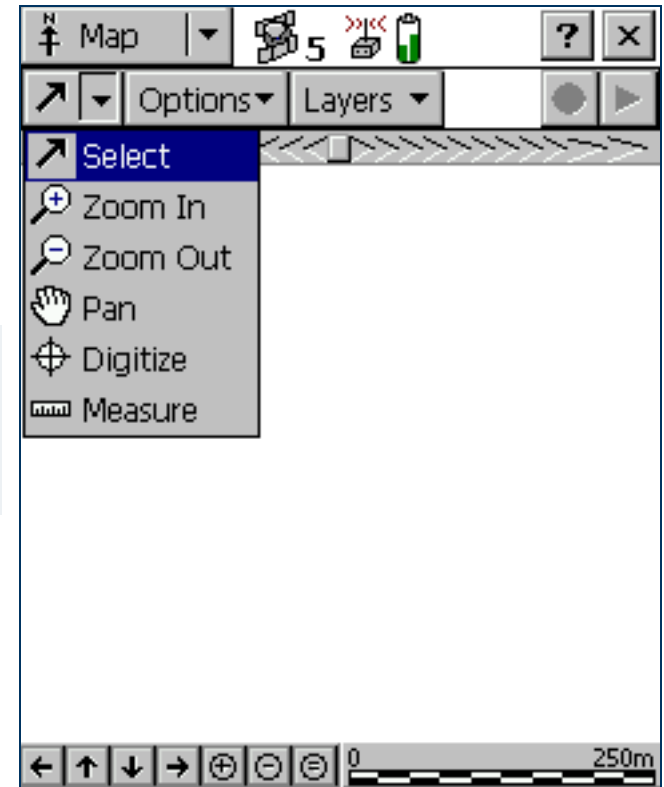

The Map section has six map tools. Only one map tool is active at a time. To change to a different map tool, tap the **Map Tools** list button and select a command from the list.

When you tap a point on the Map screen, the effect depends on the currently selected map tool. For example, if you tap a point on the map when the Zoom In tool is active, the map zooms in to the next largest scale, centered on that point.

TIP – You can use the **Command bar** to pan or zoom at any time without changing the map tool. When you use the command bar to zoom or pan, the operation is centered on the middle of the map, as if you had selected the appropriate map tool, then tapped the center of the map.



Map section: Tools

Tool	Name	Description
	Select	When the Select tool is active, tap a point on the map to highlight a position or a feature. Double-tap any feature to open it for update. For more information, see Selecting features and map points .
	Zoom In	When the Zoom In tool is selected, tap a point on the map or drag a rectangle to reduce the map scale and magnify the map display. The map zooms in on that point. For more information, see Zooming .
	Zoom Out	When the Zoom Out tool is selected, tap a point on the map to enlarge the map scale and show a greater area on the map. The map zooms out from that point. For more information, see Zooming .
	Pan	When the Pan tool is selected, tap a point on the map to pan the display so that the point is in the center of the screen. For more information, see Panning .
	Digitize	When the Digitize tool is selected, tap a point on the map to create a position for a feature. For more information, see Digitizing .
	Measure	When the Measure tool is selected, tap a series of points on the map to measure the distance between the points and the area that they enclose. For more information, see Measuring .

Map layers

Tap **Layers** to view the list of layers that you can display on the map, and to access commands for formatting layers.

Map section: Layer options

Option	Description
Filtered Features	<p>Hides or displays filtered features on the map and in the Data section. When this option has a check mark (✓) beside it, filtered features are visible. Select this option to clear the check mark and hide filtered features from view.</p> <p>TIP — You can set or clear filters in the Map section or in the Data section.</p>
Unfiltered Features	<p>Hides or displays unfiltered features on the map and in the Data section. When this option has a check mark (✓) beside it, features that have not been filtered are visible. Select this option to clear the check mark and hide unfiltered features from view.</p> <p>NOTE — When you hide or show filtered features or unfiltered features in the Data section, they are also shown or hidden in the Map section. When you hide or show filtered or unfiltered features in the Map section, they are also hidden or shown in the Data section.</p>
Between Feature GPS	<p>Hides or displays Between feature GPS positions on the map.</p>
Background	<p>Hides or displays the background file if one is selected. When this option has a check mark (✓) beside it, features in the background file are visible. Select this option to clear the check mark and hide background features from view.</p> <p>This option is not available in the TerraSync Standard edition software. You can only open background files in the Professional edition.</p>

Map section: Layer options (Continued)

Option	Description
GPS Trail	Hides or displays the GPS trail .
Background File	Opens the Background File form . Use this form to select a data or background file to be used as the map background, or clear the currently selected background. This option is not available in the TerraSync Standard edition software. You can only open background files in the Professional edition.
Layer Formatting	Opens the Layer Formatting form . Use this form to change the colors and line thicknesses used for the layers in the map.

Background File form

- **Fields**

When you tap **Layers** and select Background file, the Background File form appears. Use this form to select a file to be displayed in the background of the map, or to clear the current background selection.

NOTE — This form is not available in the **TerraSync Standard edition software**.

Two types of file can be displayed in the background:

- Data files
- Background files containing **vector** information or **raster** information

Any data file in the TerraSync software can be selected as the background file, provided it is not already open in the Data section. When you open a data file in the background, its features are visible but cannot be selected, edited, or deleted.

TIP — If you want to use a data file in the background, but will not be opening it as a data file, you can transfer the file to the TerraSync software as a **background file**. This uses less storage space, because the attribute information is removed. You cannot open a background file for data collection or update, and features in a background file cannot be selected, updated, or deleted.

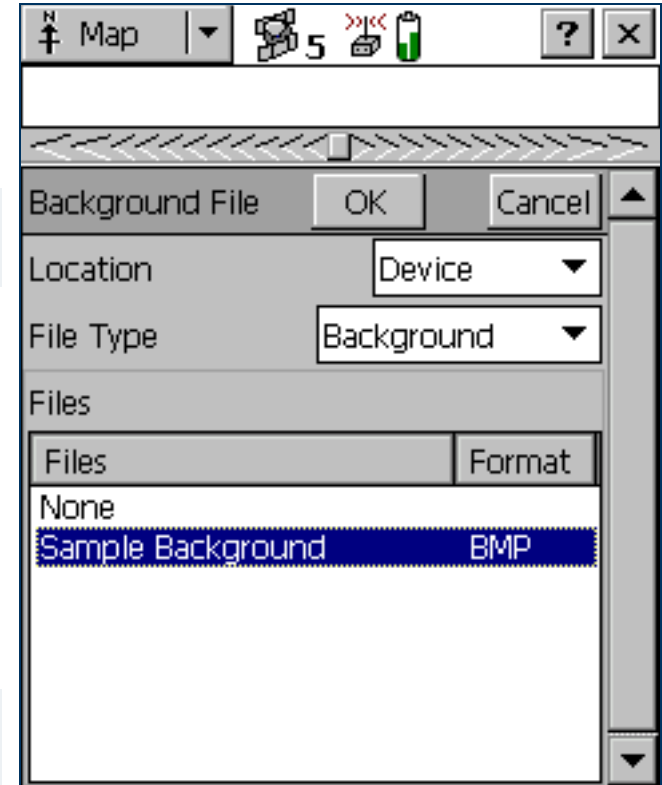

The TerraSync data file format is the only vector format supported in version 2.40 of the TerraSync software. If you want to use Shapefiles as background files, use the **Read from Shape form** in the Data section to convert Shapefiles into TerraSync data files.

You can also transfer raster files such as aerial photographs to the TerraSync software as background files. The supported formats are bitmap (.bmp), JPEG (.jpg), MrSID (.sid), and TIFF (.tif). An image file must be transferred with the following files:

- A World (.wld) file that tells TerraSync how the pixels in the file relate to real-world coordinates. You can create the World file in your GIS.
- A coordinate system file that specifies the coordinate system that the image file uses. You can create the coordinate system file either in the GPS Pathfinder Office main program, or in the Trimble Data Transfer utility at the time of transfer.

Web map server

In addition to background files that you have transferred to the field computer, you can connect to a Web map server (also known as an Internet map server, or IMS) and download raster background images.

To download background files from a Web map server:

1. Use **Panning** or **Zooming** to make sure that the area for which you want a background image is displayed on the map.

If the map server covers the area you are in, it will provide a background image that matches the current map extents.

2. Connect to the Internet using your normal connection method.

NOTE — You cannot connect to the Internet from within TerraSync.

3. Once you have established an Internet connection, open the Background File form.
4. Select Internet in the Location field, then use the fields that appear to specify a Web map server, a service, and the layers from that service that you want to download.
5. Tap **OK** to close the Background File form and download the selected background map.

This may take some time. When a download is in progress, an animated icon  appears in the top left corner of the map. Once the background file is downloaded, the hourglass icon appears until the downloaded image is rendered and becomes visible.

If you pan or zoom beyond the extents of the downloaded image, new images are downloaded automatically and displayed in the background of the map. To stop automatic downloading, either clear the map server's address from the URL field, or set the Location field to Device and select None from the list of files.

TIP — Background settings are saved when you exit the TerraSync software, so when you restart the software, any Web map server session that you have configured automatically starts again.

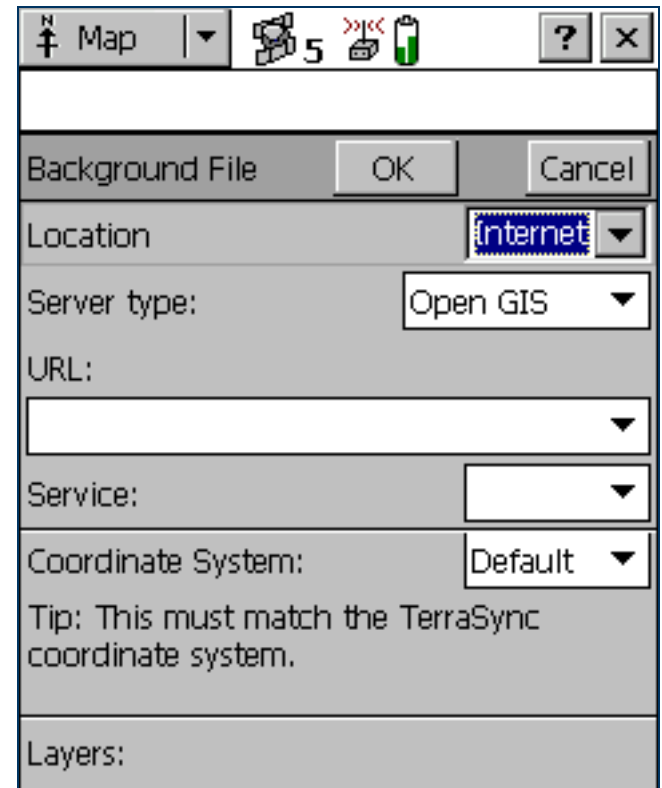

Background File form: Fields

Field	Description	Default
Location	<p>The location of the files to be listed in the Files field. The options are:</p> <ul style="list-style-type: none"> • Device Files stored in the main memory of the CE device. • Card Files on a storage card inserted in the CE device. If you have more than one card connected, there is a numbered option for each card (Card 1, Card 2, and so on). • (Drive letter) Files stored in the specified disk drive on the PC. If the PC has more than one writable disk drive, there is an option for each drive (A:, C:, and so on). • Internet Files stored on a Web map server. 	Device <i>or</i> C:
File Type	<p>The type of file to list in the Files field. The options are:</p> <ul style="list-style-type: none"> • Background Data files that have been transferred to the field computer as background files, or raster (bitmap) image files • Data Data files in the SSF format, including .ssf, .imp, and .cor files <p>This field only appears if Device or Card is selected in the Location field.</p>	Background

Background File form: Fields (Continued)

Field	Description	Default
Files	<p>A list of the files that can be displayed in the background. The Format column shows the format of each file in the list. The options are:</p> <ul style="list-style-type: none"> • BMP A bitmap (.bmp) file • JPEG A .jpg file • MrSID A .sid file • TIFF A .tif file • Trimble A Trimble data file • Vector A background file containing vector data • None No background file is selected <p>Select a filename from this list. If you select None, the current background file is closed and no background information is displayed.</p> <p>This field only appears if Device or Card is selected in the Location field.</p>	None
Server type	<p>The type of Web map server to connect to. The options are:</p> <ul style="list-style-type: none"> • ArcIMS A map server that uses the ArcIMS protocol • Open GIS A map server that conforms to the Open GIS standard 	Open GIS
URL	<p>The Internet address of the map server. Select a URL from the drop-down list, or enter the URL of the server you want to connect to.</p> <p>Once you successfully connect to a server, the server is added to the drop-down list.</p> <p>This field only appears if Internet is selected in the Location field.</p>	None
Service	<p>The map service that you want to use from the selected ArcIMS Web map server.</p> <p>If you want to connect to an Open GIS server, leave this field blank. Open GIS servers do not provide services.</p> <p>This field only appears if Internet is selected in the Location field.</p>	None

Background File form: Fields (Continued)

Field	Description	Default
Coordinate system	<p>The coordinate system that maps will be downloaded in. The selected option must match the coordinate system configured in the Coordinate System form in the Setup section.</p> <p>Some servers do not let you select a coordinate system for the images you download. If this field is not available, you must set the TerraSync coordinate system to match the coordinate system of the image. To do this, visit the website for the map server to determine the coordinate system required, and then select the same system in the TerraSync Setup section.</p> <p>This field only appears if Internet is selected in the Location field.</p>	None
Layers	<p>The layers that you want to download. Under this heading, a check box appears for each layer in the selected service.</p> <p>This field only appears if Internet is selected in the Location field.</p>	None

Layer Formatting form

- **Fields**

When you tap **Layers** and select Layer Formatting, the Layer Formatting form appears. Use this form to change the colors assigned to items in the five **Map layers**.

Features in the open data file are displayed according to the following rules:

- Feature symbols, symbol sizes, and line thicknesses are derived from the data dictionary.
- All items in a layer appear in the color assigned to that layer.
- The color assigned to a layer depends on the selected option in the Color Source field:
 - Select the Layer Color option to use the color that is selected in the corresponding Color field.
 - Select the Data Dictionary option to use the color assigned in the data dictionary.

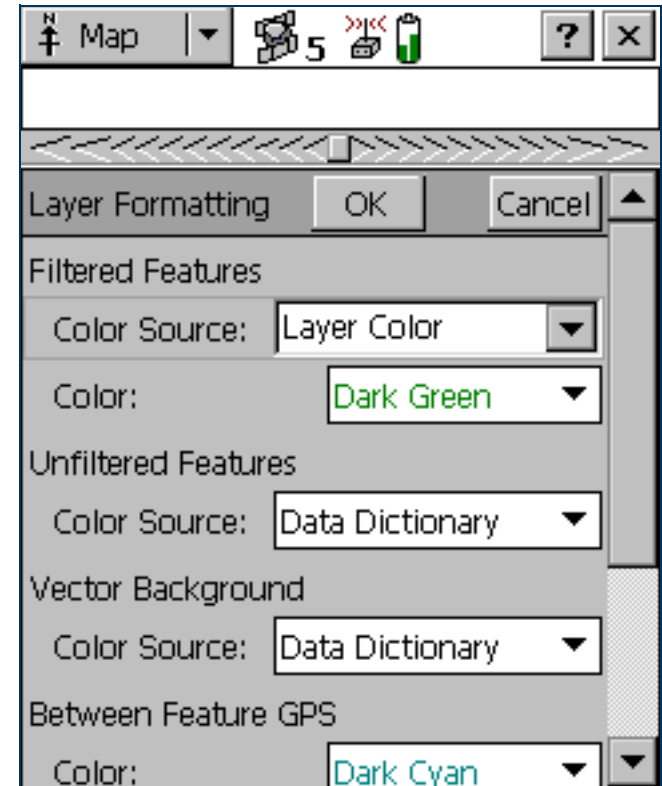

Layer Formatting form: Fields

Field	Description	Default
Filtered Features	Sets the display options for the Filtered Features layer .	(none)
Color Source	Specifies whether to display filtered features using the layer color or the color specified in the data dictionary.	Layer color
Color	The color for filtered features in the data file. This field only appears if the Color Source field is set to Layer Color.	Dark Green
Unfiltered Features	Sets the display options for the Unfiltered Features layer .	(none)
Color Source	Specifies whether to display unfiltered features using the layer color or the color specified in the data dictionary.	Data dictionary
Color	The color for unfiltered features in the data file. This field only appears if the Color Source field is set to Layer Color.	Black
Vector Background	Sets the display options for the Background layer . NOTE – This field is not available in the TerraSync Standard edition software .	(none)
Color Source	Specifies whether to display features in a file that is open in the background using the layer color or the color specified in the data dictionary.	Data dictionary
Color	The color for background features if the background file contains feature information. This field only appears if the Color Source field is set to Layer Color. NOTE – This field is not available in the TerraSync Standard edition software .	Dark Magenta
Between Feature GPS	Sets the display options for the Between Feature GPS layer .	(none)
Color	The color for Between feature GPS positions.	Dark Cyan

Layer Formatting form: Fields (Continued)

Field	Description	Default
GPS Trail	<p>Sets the display options for the GPS Trail layer.</p> <p>NOTE — In addition to the GPS trail, the following items appear in the color assigned to the GPS Trail layer:</p> <ul style="list-style-type: none"> • Current position • Map point • Bearing to go arrow • Line segments between digitized positions for the current feature • Line segments between measured points <p>However, when the GPS Trail layer is hidden, these map items are not hidden.</p>	(none)
Color	The color for the GPS trail .	Dark Red
Navigation	Sets display options for the Navigation layer.	(none)
Color	The color for the Navigation start and Navigation target .	Blue

Enter Coordinates form

- **Fields**

When you tap **Options** and select Enter Coordinates, the Enter Coordinates form appears. Use this form to record a manual position for the open feature by entering its coordinates.

This option is only available if there is an open feature and the Map section is in **Digitize mode**. A point feature can contain only one position, but a line or area feature can contain any number and combination of manual, digitized, and GPS positions.

For more information, see **Creating manual positions**.

The screenshot shows a mobile application interface for entering coordinates. At the top, there is a title bar with a 'Map' label and a dropdown arrow, followed by several icons: a 3D map icon with the number '5', a red 'X' icon, a battery level icon, a location pin icon, a question mark icon, and a close 'X' icon. Below the title bar, the text 'Enter Coordinates' is displayed, followed by 'OK' and 'Cancel' buttons. The form contains three input fields, each with a question mark placeholder: 'Latitude:', 'Longitude:', and 'Altitude (HAE - Meters):'. The bottom portion of the form is a solid gray area.

Enter Coordinates form: Fields

Field	Description	Default
Latitude	<p>The latitude of the manual position. You can use one of the following formats:</p> <ul style="list-style-type: none"> • DD° MM'SS.ss" • DD° mm.mmm' • DD.ddd° <p>The value that you enter is displayed in the units specified in the Coordinate System form. This field only appears if the current coordinate system is Lat/Long.</p> <p>NOTE — To indicate a Southern hemisphere latitude or Western hemisphere longitude, you must include the hemisphere letter (S or W) or a minus sign (-). The hemisphere letter or plus sign is optional for Northern or Eastern hemisphere positions.</p> <p>TIP — The symbols for degrees (°), minutes ('), and seconds (") can be omitted or replaced with a space, but you must include the decimal point (.).</p>	?
Longitude	<p>The longitude of the manual position. The formats you can use are as for the Latitude field. This field only appears if the current coordinate system is Lat/Long.</p>	?
North	<p>The northing of the manual position, in the coordinate units specified in the Coordinate System form. This field only appears if the current coordinate system uses North/East.</p>	?
East	<p>The easting of the manual position, in the coordinate units specified in the Coordinate System form. This field only appears if the current coordinate system uses North/East.</p>	?
USNG	<p>The northing and easting of the manual position, in USNG format. This field only appears if you have enabled USNG display in the Coordinate System form.</p>	?
Altitude	<p>The altitude of the manual position. The altitude is expressed as a Height Above Ellipsoid or Mean Sea Level, depending on the option configured in the Coordinate System form, and is in the altitude units specified in this form. This field only appears if you have enabled USNG display in the Coordinate System form.</p>	?

Using the Map section

You can move around the map, hide or display different parts of the map, and select features or points of interest.

NOTE — Imported files cannot be opened in the TerraSync Standard edition software.

- Selecting features and map points
- Panning
- Zooming
- Creating and ending features from the Map section
- Digitizing
- Creating manual positions
- Measuring
- Setting and clearing the navigation start and target

Selecting features and map points

When a feature is selected in the **Data section**, it becomes the selected feature in the map.

When you select a feature from the map and there is no open feature in the Data section, the feature selected on the map is highlighted in the Choose Feature list in the Data section's **Update Features screen**.

To select a feature on the map, make sure that the **Select tool** is active, then tap the feature. The feature is highlighted and a position information tooltip, including the coordinates, feature number, and name, is displayed.

The position information tooltip remains visible until you tap the tooltip, another feature, a different map point, or anywhere else on the screen. The feature remains selected (highlighted) until you tap another feature.

When you select a **Map point** (not a feature), that last feature that you selected on the map remains highlighted.

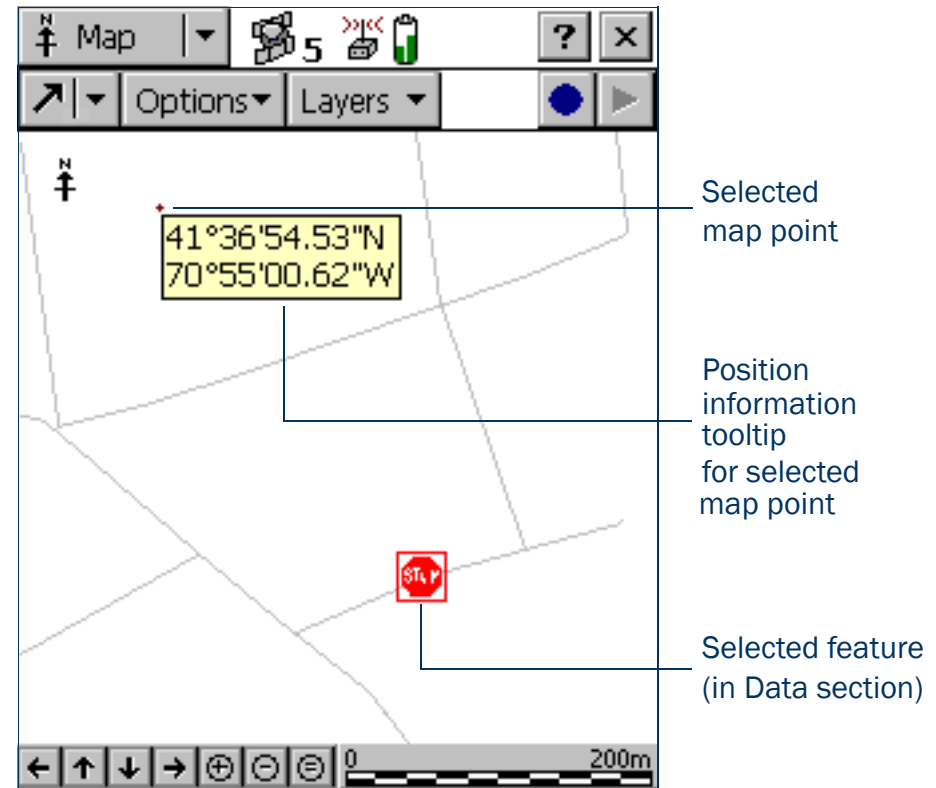

Panning

When you pan, you change the area that is visible in the Map screen by sliding the map left, right, up, or down. Panning does not change the scale at which you are viewing the map.

You can pan to any location by selecting the **Pan tool** and tapping on the location. The map pans so the selected location is in the center of the display.

To pan half a screen width or height in any direction without changing the currently selected map tool, tap the appropriate panning button on the **Command bar** at the bottom of the Map screen.

The two Auto Pan options let you control the map automatically. You can set either option, or clear both to retain full manual control over the map display.

When you select the **Auto Pan to GPS Position option**, the TerraSync software always ensures that the map shows the current GPS position. Whenever the GPS position moves to or beyond the edge of the display, the map automatically pans until the GPS position is in the center of the screen.

The **Auto Pan to Selection option** ensures that the currently selected position is always visible by automatically panning whenever the selected feature is at the edge of the display, or beyond it. When you tap close to the edge of the map, the map automatically pans (half a screen width or height) in the direction of the movement. The selected point remains at the same geographic position. In these circumstances, the current GPS position may not be visible.

Zooming

When you zoom, you change the map scale to display a larger or smaller area. You can zoom in to view a few features that are close together, or zoom out for an overview of the features you have collected so far.

To zoom in, make the **Zoom In tool** active and tap the location on the map you want to zoom in on. Alternatively, tap the Zoom In button on the **Command bar** to zoom in on the center of the map.

You can also zoom in by dragging across the map when the Zoom In tool is active. As you drag, a rectangle appears. The diagonal of the rectangle is the line between the point where you started dragging and the last point you dragged to. When you stop dragging, the map zooms in on the rectangle.

NOTE — If the rectangle you draw is very small, the map does not zoom.



To zoom out, make the **Zoom Out tool** active and tap the location you want to zoom out from. Alternatively, tap the Zoom Out button on the **Command bar** to zoom out from the center of the map.

NOTE — You cannot zoom out by dragging a rectangle. This method is for zooming in only.

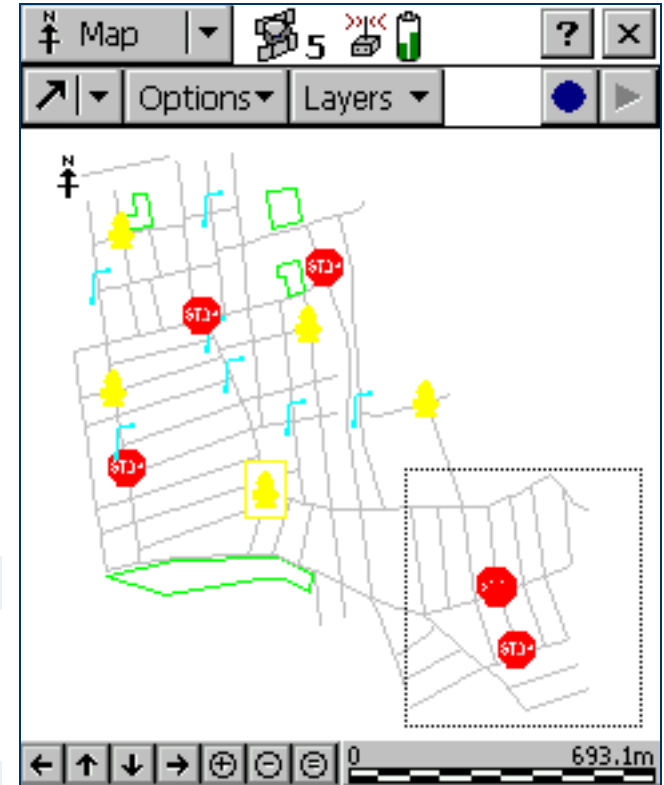
To view all the features in all visible layers, tap the Zoom Extents button on the **Command bar**, or select Zoom Extents from the **Options list**. The map scale increases until all points in all the visible layers appear. **Map layers** you can display include features in the data file and background file, the current GPS position, and past GPS positions.



Creating and ending features from the Map section

You can use the Create Feature  button and the End Feature  button to open a new feature, or to close a feature that is already open in the Data section. When you tap the Create Feature button, a drop-down list appears, showing each feature type that is defined in the open file's data dictionary. Select a feature type from this list to open its attribute entry form.

Whenever a feature is open, whether it was opened from the Map section or from the Data section, you can close it by tapping the End Feature button. If you have collected insufficient positions, have not entered all the feature's attribute values, or have set the **Confirm End Feature field** in the Logging Settings form to Yes, you will be asked to confirm that you want to close this feature. When you close a feature using the End Feature button, you are returned to the section that you opened the feature from. If you used the Create Feature button, you are returned to the Map section. Otherwise, you are returned to the Data section.

TIP – To create digitized positions from the map, you need an open feature. Use the Create Feature button to open a new feature without switching to the Data section. For more information, see [Digitizing](#).

Digitizing

Digitizing is the process of creating positions for a feature by selecting points on the map, instead of using GPS positions. A line or area feature can contain both GPS and digitized positions, but you must pause GPS logging before you can digitize positions.

To record digitized positions:

1. Make sure that the new or existing feature that you want to add positions to is open in the Data section. If no feature is open, you can use the Create Feature button in the Map section to quickly open a new feature. For more information, see [Creating and ending features from the Map section](#).
2. Make sure that GPS logging is paused.

TIP — Use the [Log Later option](#) to prevent GPS logging from starting automatically when you start a new feature.

3. Make the [Digitize tool](#) active. The Digitize icon appears in the [Status bar](#).
4. Tap the location on the map where you want to create a position. If the location you tap is close to an existing position, the new position will “snap” to the same location. This is a useful feature when you want to create line or area features with shared boundaries.

TIP — Whether or not a digitized position snaps to an existing one depends on how close the two positions are in the map display. It does not depend on the distance between their actual coordinates. To record a digitized position without snapping to a nearby position, zoom in to increase the distance between the two positions on the screen.

To record a digitized area or line feature, tap the location where you want each vertex.

The number beside the Digitize icon increments to show the number of digitized positions in the current feature. A line appears on the map, joining all the vertices recorded so far.

A digitized point feature can contain only one position, so if you tap again while a point feature is open, an error message appears.

Any offset you have configured for the feature is applied to each digitized position. The map location that you tap is the position that the offset is measured from.

If you tap the wrong location, use the Undo button  to remove the incorrect position. You can undo any number of positions recorded for the current feature, in reverse order, up to the last GPS position recorded.

For example, if you have recorded four digitized positions, you can undo the fourth, then the third, and then the second position, by tapping the Undo button three times. Once you have undone all the positions in a feature, the Undo button becomes unavailable.

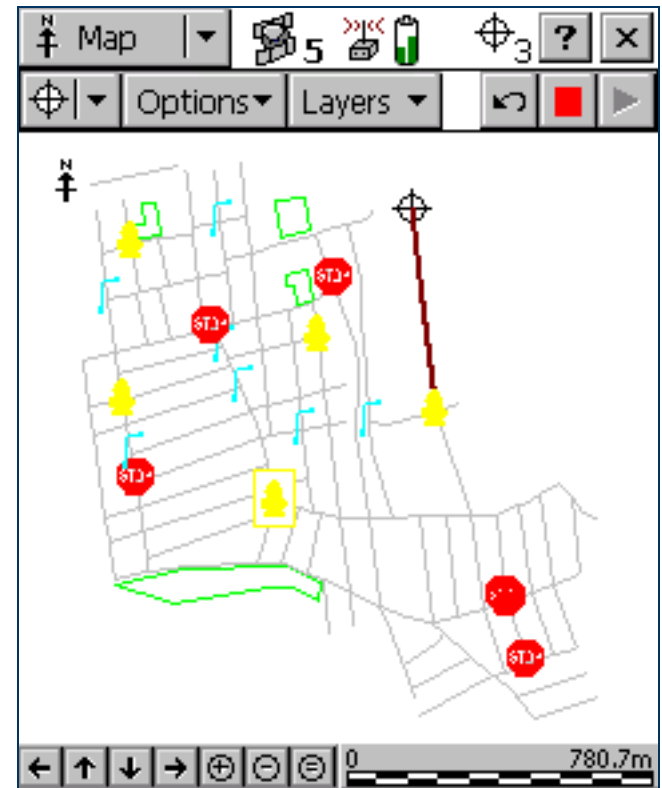

NOTE — You cannot undo a GPS position. Once you have undone all digitized positions in the feature up to the last GPS position, the Undo button becomes unavailable, even if there are other digitized positions in the feature that you recorded before the GPS position.

To record GPS positions, simply tap the Resume button to resume logging GPS. When you are logging GPS positions, you cannot record digitized positions. However, you do not leave Digitize mode until you select one of the other **Map tools**, so you can quickly switch between GPS and digitized positions using the Pause and Resume buttons.

Creating manual positions

A manual position is a position that you create by entering its coordinates manually. A line or area feature can contain a mixture of GPS, manual, and digitized positions, but a point feature can contain either GPS positions or a single manual or digitized position.

Manual positions can be recorded under the same conditions as digitized positions:

- There must be a feature open.
- GPS logging must be paused.
- The **Digitize tool** must be active.

For more information, see [Digitizing](#).

To record a manual position:

1. Tap Options in the Map section.
2. Select Enter Coordinates. The **Enter Coordinates form** appears. The fields that appear (Latitude, Longitude, and Altitude, or North, East, and Altitude) depend on the current coordinate system.
3. Enter the coordinates of the position.
4. Tap **OK** to close the form and store the position.

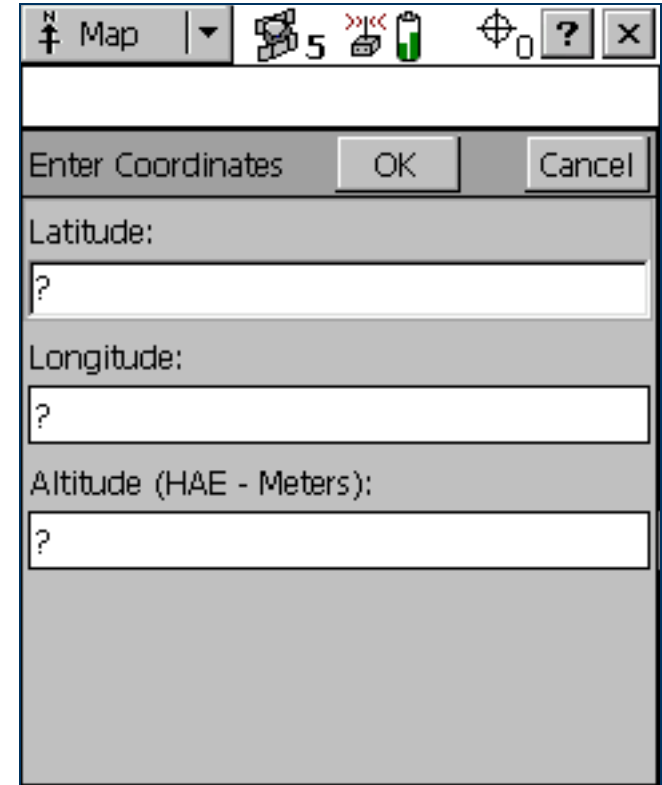

Measuring

You can use the **Measure tool** to measure the distance between points, or the area enclosed by a set of points. To measure a distance or area:

1. Make the Measure tool active. A tooltip appears in the top left corner of the map.
2. Tap on the map location where you want to start measuring.
3. Tap on each point that you want to measure to. The last position that you tapped is marked with a cross $+$, and the measured points are connected by a line. As you add points to the measurement, the distance and bearing are updated in the tooltip. The distance shown is the total line length, while the bearing is the bearing of the last line segment that you measured.

TIP — If the location you tap is close to the GPS cursor or a point on an existing feature, the point will “snap” to that position. This is a useful feature when you want to measure the length or area of a feature.

4. To end the measurement, do one of the following:
 - Double-tap the last point.
 - Tap the End Measurement button .

The area enclosed by the measured points is displayed in the tooltip. You do not have to join the first and last points; TerraSync assumes that these points are joined when it calculates the area.

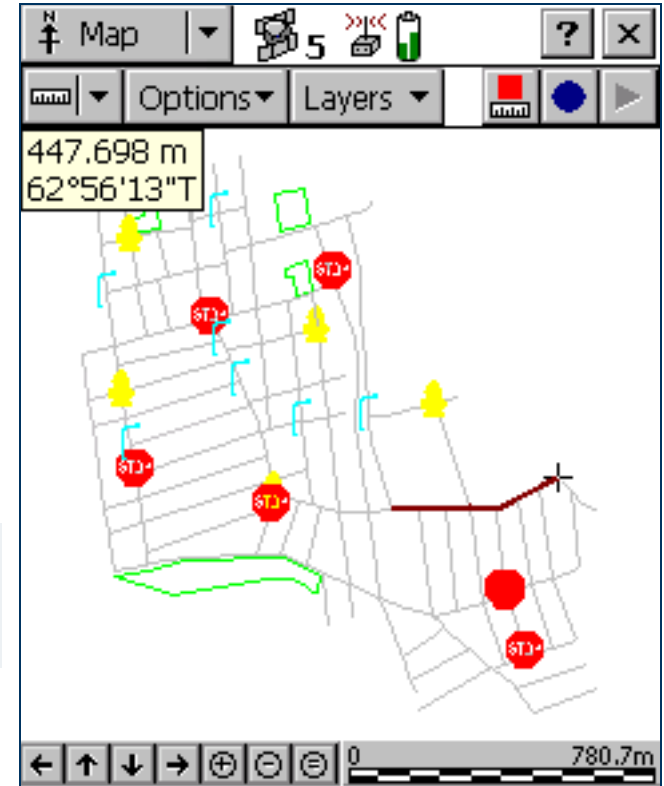

Setting and clearing the navigation start and target

To navigate to a location using the Navigation section, you must set a navigation target. If you want to use the **Lightbar** to navigate, you must also set a navigation start position. You can set both the navigation start and target either in the Map graphical screen or in the Data section.

Setting the navigation start

The navigation start can be any of the following items:

- the selected map point
- the selected point feature
- the start, middle, end, or selected vertex of the selected line feature
- the start/end, centroid, or selected vertex of the selected area feature
- the current GPS position

To set the navigation start in the Map section:

1. If you want to navigate from a point on the map, or from a feature, select the map point or feature.
2. Tap **Options** and then select Set Nav Start.

3. Select the start option that you require. Do one of the following:
 - To set the start to the current GPS position, select GPS.
 - To set the start to the selected map point, select Map Point.
 - To set the start to a location on the selected feature, select one of the feature options. The feature options are identified by the feature number and feature type (for example, **173 Road - Start** is the feature option for the start point of the Road feature that has ID number 173).

The start icon  appears over the selected map point, feature, or position.

TIP — A start icon also appears beside the selected feature in the **Update Features screen**.

NOTE — If you have specified a navigation start and target, but the start is farther from your position than the configured **Range**, you must navigate to the start before you can navigate to the target. Until you are within the close-up range of the navigation start, the Navigation section guides you to the navigation start.

Setting the navigation target

The navigation target can be any of the following items:

- the selected map point
- the selected point feature
- the start, middle, end, or selected vertex of the selected line feature
- the start/end, centroid, or selected vertex of the selected area feature
- a position that you specify as an offset from the start position

To set the navigation target in the Map section:

1. If you want to navigate to a point on the map, or to a feature, select the map point or feature.
2. Tap **Options** and then select Set Nav Target.

3. Select the target option that you require. Do one of the following:
 - To set the target to the selected map point, select Map Point.
 - To set the target to a location on the selected feature, select one of the feature options. The feature options are identified by the feature number and feature type (for example, **3 Park - Centroid** is the feature option for the center of the Park feature that has ID number 3).
 - To enter a target position manually, select Construct. The **Construct Target Offset form** appears. Enter the bearing and distance from the start to the target, then tap **OK**.

NOTE — The Construct option is only available if you have set the navigation start.

The target icon  appears over the selected map point, feature, or position. If a navigation start is also defined, the start and target are joined by a line that shows the most direct navigation path.



TIP — A target icon also appears beside the selected feature in the **Update Features screen**.

Clearing the navigation start and target

To clear the navigation start and target, tap **Options** and select Clear Nav Targets. The start and target icons disappear from the Map section and from the Data section's Update Features screen. In the Navigation section, the lightbar is grayed out and the message **Set your nav target in the Map or Data section** appears. You cannot navigate until you set a new target.

Controlling logging from the Map section

When the attribute entry form for a feature is open in the Data section, you can use the Log and Pause buttons in the Map to start, pause, or resume logging, just as you would tap **Log**, **Pause**, or **Resume** in the Data section.

The two buttons perform the same function, so they are synchronized. For example, if you tap **Pause** in the Data section, its label changes from **Pause** to **Resume**, and logging is suspended. At the same time, the Log button  in the Map section is replaced by the Pause button . You can use either the Log button in the Map section or **Resume** in the Data section to start logging again.

For more information, see [Pausing and resuming logging](#).

Data section

To open the Data section, tap the Section list button and select Data. Use this section to open data files, collect new data, update existing data, and manage files in the field.

The Data section has five subsections:

Subsection	Availability
• New File	When no data file or base file is open.
• Existing File	When no data file or base file is open.
• Update Features	When a data file is open.
• Collect Features	When a data file or base file is open.
• File Manager	Always available.



New File

- **Fields**

To open the New File subsection, tap the Subsection list button and select New File. The New File screen appears.

Use the New File subsection to create a new data file for logging features and GPS positions.

When you have selected a file type, filename, and (for rover files only) a data dictionary, tap **Create** to create a new file.

If the new file is a rover file, the **Collect Features screen** opens. If the new file is a base file, the first step of the **Base Station Setup wizard** appears.

TIP — Once you have logged features to the new file, you can switch to the **Update Features form** to edit features you have collected so far.

The screenshot shows the 'New File' screen in the TerraSync application. At the top, there is a 'Data' menu with a dropdown arrow, a 'New' dropdown, and a 'Create' button. Below this, the screen is titled 'Create New Data File:'. There are three input fields: 'File Type' with a dropdown menu showing 'Rover', 'File Name' with a text input field containing 'Starfish', and 'Dictionary Name' with a dropdown menu showing 'Seaview'. The background is a light gray color.

New File screen: Fields

Field	Description
File Type	<p>The type of data that will be stored in the new file. The options are:</p> <ul style="list-style-type: none">• Rover The new file will contain feature, attribute, and position information.• Base The new file will contain base GPS data recorded at a stationary location, or will allow you to set up the connected GPS receiver as an unattended base station, broadcasting correction messages. <p>If the connected receiver is a Trimble® 5700 or 5800 receiver, you cannot log base data to file; you can only generate corrections for broadcast. If any other receiver that supports carrier phase logging is connected, you can log data to a base file, broadcast corrections, or both.</p>
File Name	<p>The name of the new file. When you open this section, the TerraSync software automatically generates a filename for the new data file, using the date and time from the field computer's clock. It uses the formula RMMDDHHX for rover files, and BaseMMDDHHX for base files, where:</p> <ul style="list-style-type: none">• R or Base is the Filename Prefix,• MM is the current month,• DD is the current day of the month,• HH is the current hour of the day,• X increments within this hour, starting at A for the first file in that hour, then B for the second file, and so on. <p>TIP — You can change the prefix character for rover files in the Logging Settings form in the Setup section.</p> <p>The auto-generated filename is only a suggestion. You can edit it, or replace it with an entirely different name. Filenames must follow the naming rules for Windows.</p>

New File screen: Fields (Continued)

Field	Description
Dictionary Name	<p>The data dictionary that will be associated with the new file. This field lists all the data dictionaries currently loaded in the TerraSync software. The default data dictionary is the last dictionary you used. The Generic data dictionary is always available. It lets you record point, line, and area features, each with a simple descriptive attribute.</p> <p>NOTE — When you create a data file, a copy of the data dictionary you select is permanently associated with that file. This embedded data dictionary determines what types of features can be recorded to the file, and what attributes the features have.</p> <p>This field only appears when Rover is selected in the File Type field.</p>

Confirm Antenna Height form

- **Fields**

This form lets you check the configured antenna height and measurement position, so that you can accurately record altitude data. The Height field defaults to the current value from the **Height field** in the Antenna Settings form, and the Measure To shows the current value from the **Measure Height To field**. If you change either value, it is also changed in the Logging Settings form.

If the **Confirm field** in the Antenna Settings form is set to Per File, this form appears whenever you tap **Create** in the **New File screen**, or **Open** in the **Existing File screen**.

If the **Confirm field** in the Antenna Settings form is set to Per Feature, this form appears whenever you create a new feature or update an existing feature's position information.

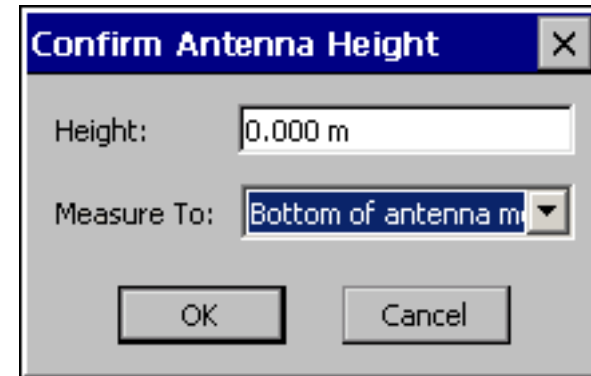

Confirm Antenna Height form: Fields

Field	Description	Default
Height	The height of the GPS antenna that is connected to the GPS receiver. This is used as a vertical offset on each position.	The current value from the Height field in the Antenna Settings form.
Measure Height To	The point on the antenna that the height is measured to. If the selected antenna type does not allow alternative measurement locations (for example, if you are using the internal antenna in a GeoExplorer CE series handheld), this field does not appear.	The current value from the Measure Height To field in the Antenna Settings form.

Base Station Setup wizard

The Base Station Setup wizard guides you through the process of setting up a GPS receiver to broadcast real-time corrections or log base data to file. To start the Base Station Setup wizard, select Base in the File Type field on the **New File screen**, and then tap **Create**.

For detailed information about using TerraSync to set up a receiver as a base station, see **Setting up a base station**.

The wizard contains the following steps:

- **Antenna Settings step**
- **Logging and GPS Settings step**
- **Real-Time Output step**
- **Reference Position step**

Antenna Settings step

- Buttons
- Fields

This is the first step of the **Base Station Setup wizard**. Use this step to specify the antenna type that you are using, and its height.

When you have finished, tap **Next** to move to the **Logging and GPS Settings step**.

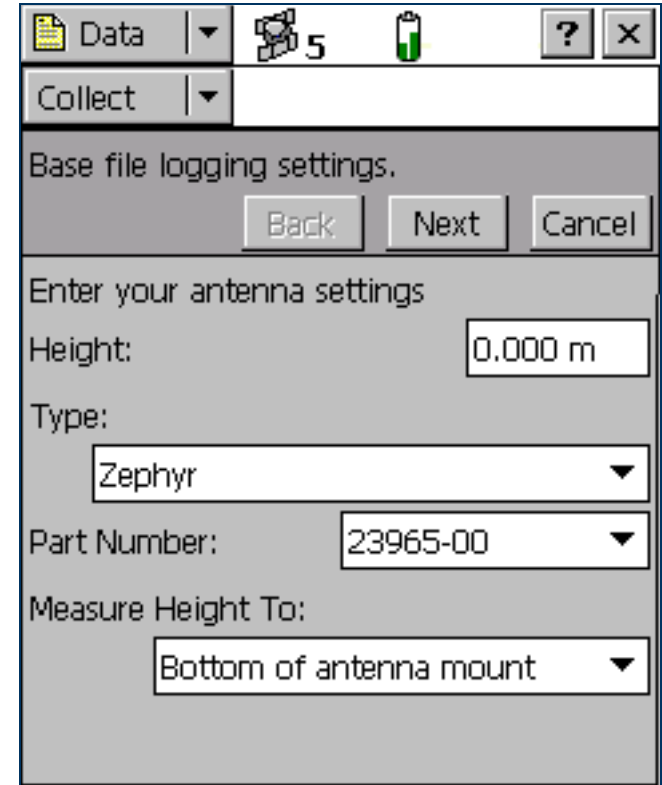

The screenshot shows a mobile application interface for the 'Antenna Settings' step. At the top, there is a status bar with 'Data', signal strength, '5', battery level, and window controls. Below the status bar is a 'Collect' dropdown menu. The main content area is titled 'Base file logging settings.' and contains three buttons: 'Back', 'Next', and 'Cancel'. Below this is the section 'Enter your antenna settings' with the following fields: 'Height:' with a text input field containing '0.000 m'; 'Type:' with a dropdown menu showing 'Zephyr'; 'Part Number:' with a dropdown menu showing '23965-00'; and 'Measure Height To:' with a dropdown menu showing 'Bottom of antenna mount'.

Antenna Settings step: Buttons

Button	Description
Next	Moves on to the Logging and GPS Settings step .
Cancel	Cancels the Base Station Setup wizard and returns to the New File screen .

Antenna Settings step: Fields

Field	Description	Default
Height	The height of the GPS antenna that is connected to the GPS receiver. This is used as a vertical offset on each position.	0.00 m
Type	The type of antenna that is connected to the GPS receiver. For more information, see Antenna Settings form .	Unknown External
Part Number	The part number of the antenna that is connected to the GPS receiver. For more information, see Antenna Settings form .	n/a
Measure Height To	The point on the antenna that you have measured to. TerraSync automatically adjusts the antenna height by the distance between the measurement location and the Antenna Phase Center (APC). For more information, see Antenna Settings form .	(none)

Logging and GPS Settings step

- Buttons
- Fields

This is the second step of the **Base Station Setup wizard**. Use this step to specify the logging interval and GPS settings for the base station.

When you have finished, tap **Next** to move to the **Real-Time Output step**.

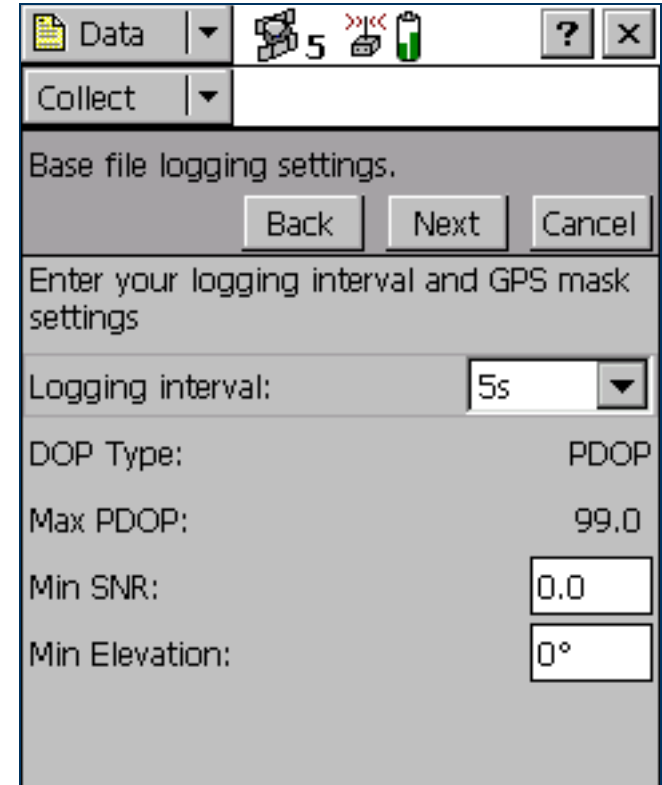

The screenshot shows a mobile application interface for configuring a base station. At the top, there is a status bar with icons for 'Data', signal strength (5 bars), a red 'X' icon, and a battery level indicator. Below the status bar is a 'Collect' dropdown menu. The main content area is titled 'Base file logging settings.' and contains three buttons: 'Back', 'Next', and 'Cancel'. Below this is a section titled 'Enter your logging interval and GPS mask settings'. It includes a 'Logging interval:' label with a dropdown menu set to '5s'. Below that are four rows of settings: 'DOP Type:' with a value of 'PDOP', 'Max PDOP:' with a value of '99.0', 'Min SNR:' with a text input field containing '0.0', and 'Min Elevation:' with a text input field containing '0°'.

Logging and GPS Settings step: Buttons

Button	Description
Back	Returns to the Antenna Settings step .
Next	Moves on to the Real-Time Output step .
Cancel	Cancel the Base Station Setup wizard and returns to the New File screen .

Logging and GPS Settings step: Fields

Field	Description	Default
Logging interval	The logging interval, in seconds, for the base station data. The options are: <ul style="list-style-type: none">• 1s• 5s• 10s	5s
DOP Type	The type of DOP value to use. This field is read-only.	PDOP
Max PDOP	The maximum PDOP value. This field is read-only.	99.0
Min SNR	The minimum SNR value. The SNR is a measure of the quality of the signal from a satellite. When a satellite's SNR falls below the minimum value, the TerraSync software stops using that satellite to calculate the base station's GPS position. If the GPS receiver is a 5700 or 5800 receiver, this field shows N/A.	0.0
Min Elevation	The minimum elevation. Signals from satellites that have a low elevation from the horizon can be of poor quality. The TerraSync software does not use any satellite that is below the minimum value to calculate the base station's GPS position.	0°

Real-Time Output step

- Buttons
- Fields

This is the third step of the **Base Station Setup wizard**. Use this step to specify whether the base station will output real-time differential correction messages, to configure the receiver port, and to define message settings.

When you have finished, tap **Next** to move to the **Reference Position step**.

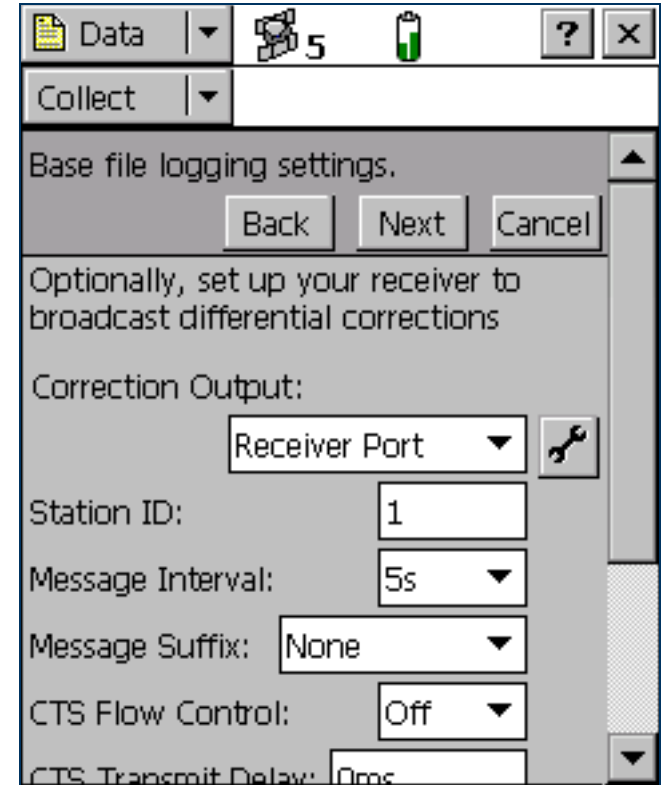

Real-Time Output step: Buttons

Button	Description
Back	Returns to the Logging and GPS Settings step .
Next	Moves on to the Reference Position step .
Cancel	Cancels the Base Station Setup wizard and returns to the New File screen .

Real-Time Output step: Fields

Field	Description	Default
Correction Output	<p>This field specifies whether differential corrections will be output for broadcast. The options are:</p> <ul style="list-style-type: none">• Off Do not output differential corrections. If this option is selected, this is the only field on the form.• Receiver Port Output differential corrections on the receiver port. To configure the receiver port, tap the Setup button beside this field. The Receiver Port Settings form appears. <p>NOTE — When you configure a GPS Pathfinder[®] receiver to output RTCM messages, the communication settings you set in this form override the NMEA output and RTCM input settings defined in the NMEA Output Settings form, Serial Port Settings form, or Receiver Port Settings form.</p>	Off
Station ID	The ID number that the base station will use to identify itself to rovers. Enter a station ID number between 0 and 1023.	1

Real-Time Output step: Fields (Continued)

Field	Description	Default
Real-time Protocol	<p>The message format to be used. The options are:</p> <ul style="list-style-type: none"> • RTK/DGPS RTCM 2.1 • RTK/DGPS RTCM 2.2 • RTK/DGPS RTCM 2.3 • CMR • CMR+ <p>The protocol that you choose depends on the message formats supported or required by rovers:</p> <ul style="list-style-type: none"> • Choose an RTCM option to output all the message types required for RTK and DGPS rovers. Use the latest RTCM version that is compatible with all rovers. • Choose a CMR option if all rovers are Trimble RTK rovers. CMR is more efficient than RTCM, but may not be supported by non-Trimble receivers. <p>This field only appears if the GPS receiver is a 5700 or 5800 receiver. For other receivers, the RTCM 2.1 message format is used.</p>	RTK/DGPS RTCM 2.1
Message Interval	<p>The interval, in seconds, at which correction messages are output. The options are:</p> <ul style="list-style-type: none"> • 1s • 5s • 10s <p>If the connected receiver is a 5700 or 5800 receiver, this field is read-only. These receivers output messages at a 1-second interval.</p>	1s

Real-Time Output step: Fields (Continued)

Field	Description	Default
<p>The following five fields configure advanced communication settings. Do not change the settings in these fields unless you are having trouble configuring communications between TerraSync and the data radio. For information on recommended settings, refer to the documentation for the data radio.</p>		
Message Suffix	<p>The formatting characters to append to the end of each message. The options are:</p> <ul style="list-style-type: none"> • None Do not append any suffix to messages. • <CR> Append a carriage return to the end of each message. • <LF> Append a line feed to the end of each message. • <CR><LF> Append a carriage return and line feed to the end of each message. 	None
CTS Flow Control	<p>This field specifies whether clear-to-send (CTS) flow control is enabled on RTCM output. The options are:</p> <ul style="list-style-type: none"> • Off • On <p>This field does not appear if the GPS receiver is a 5700 or 5800 receiver.</p>	Off
CTS Transmit Delay	<p>The delay between transmitting the CTS message and the RTCM correction. Enter a value between 0 ms and 5,000 ms.</p> <p>This field does not appear if the GPS receiver is a 5700 or 5800 receiver.</p>	0ms
RTS Mode	<p>The ready-to-send (RTS) mode. The options are:</p> <ul style="list-style-type: none"> • Rx • High • Tx • Low <p>This field does not appear if the GPS receiver is a 5700 or 5800 receiver.</p>	High

Real-Time Output step: Fields (Continued)

Field	Description	Default
RTS Edge Delay	<p>The delay between transmitting the RTS message and the RTCM correction. Enter a value between 0 ms and 5,000 ms.</p> <p>This field does not appear if the GPS receiver is a 5700 or 5800 receiver.</p>	0ms
Receiver Power Output	<p>This field specifies whether the connected receiver outputs power. If the connected GPS receiver can be configured to supply power, you can use this field to enable power output for an external device such as a DGPS radio. The options are:</p> <ul style="list-style-type: none"> • Auto Corresponds to the On option for a GPS Pathfinder Power receiver; corresponds to Off for all others. • On Enable power output. • Off Disable power output. <p>WARNING — Enabling power output can damage some CE devices. Trimble recommends that you always select the Auto option unless you require power to another external device <i>and</i> have protected the CE device from power supplied by the GPS receiver.</p> <p>For more information, see Receiver power output.</p> <p>This field does not appear if the GPS receiver is a 5700 or 5800 receiver.</p>	Auto

Receiver Port Settings form

- **Fields**

This form appears when you tap the Setup button in the **Real-Time Output step**.

Use this form to configure communication settings between the GPS receiver port and the data radio that is used to broadcast the correction messages.

This form contains the same fields as the **Receiver Port Settings form** in the Real-time subsection of the Setup section.

The screenshot shows a mobile application interface with a 'Receiver Port Settings' dialog box. At the top, there is a 'Data' dropdown menu and a 'Collect' dropdown menu. The dialog box has a title bar with 'Receiver Port Settings' and 'OK' and 'Cancel' buttons. The settings are as follows:

Field	Value
Receiver Port:	Port 1
Port Configuration:	TRIMTALK 450
Port Settings:	
Baud Rate:	38400
Data Bits:	8
Stop Bits:	1
Parity:	Odd

Reference Position step

- Buttons
- Fields

This is the last step of the **Base Station Setup wizard**. Use this step to specify the latitude, longitude, and altitude, or the northing, easting, and altitude, of the reference position.

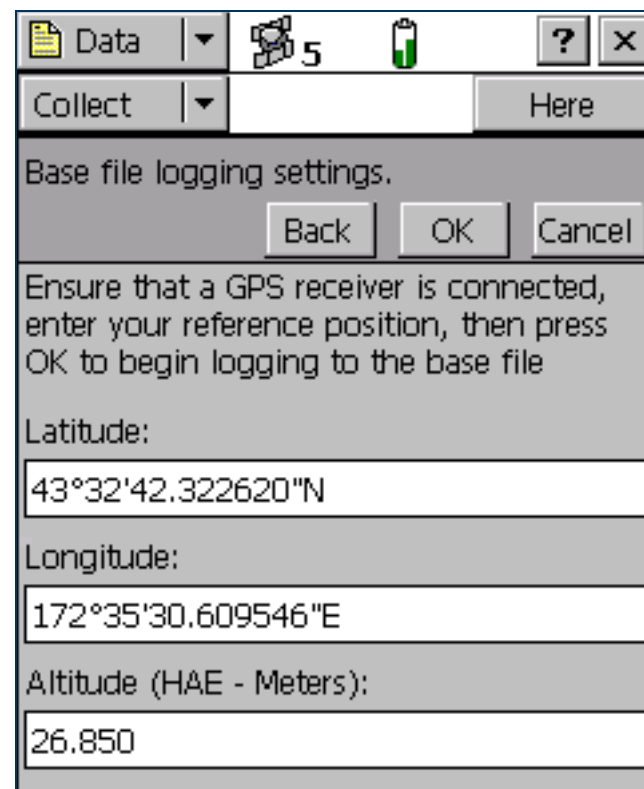

The screenshot shows a software dialog box titled "Base Station Setup wizard". At the top, there is a toolbar with a "Data" menu, a signal strength indicator showing 5 bars, a battery level icon, and help/cancel buttons. Below the toolbar is a "Collect" menu and a "Here" button. The main area of the dialog is titled "Base file logging settings." and contains three buttons: "Back", "OK", and "Cancel". Below this is a text instruction: "Ensure that a GPS receiver is connected, enter your reference position, then press OK to begin logging to the base file". There are three input fields: "Latitude:" with the value "43°32'42.322620"N", "Longitude:" with the value "172°35'30.609546"E", and "Altitude (HAE - Meters):" with the value "26.850".

Reference Position step: Buttons

Button	Description
Here	<p>Sets the reference position to the current GPS position.</p> <p>NOTE — Because the current GPS position is autonomous, using the Here button will result in an inaccurate reference position. Trimble recommends that you set the base station up over a known, surveyed point, and enter the exact reference position. If you do use the Here button, Trimble recommends that you apply a coordinate transformation in the GPS Pathfinder Office software to calibrate the base data.</p> <p>TIP — You can use this button to speed up data entry. Press Here to quickly fill in an approximate position, and then replace only the digits that are incorrect.</p>
Back	Returns to the Real-Time Output step .
OK	Ends the Base Station Setup wizard and begins logging base data. The Collect Base Data screen appears.
Cancel	Cancels the Base Station Setup wizard and returns to the New File screen .

Reference Position step: Fields

Field	Description
Latitude	<p>The latitude of the reference position. You can use one of the following formats:</p> <ul style="list-style-type: none">• DD°MM'SS.ss"• DD°mm.mmm'• DD.ddd° <p>The value that you enter is displayed in the units specified in the Coordinate System form. This field only appears if the current coordinate system is Lat/Long.</p> <p>NOTE — To indicate a Southern hemisphere latitude or Western hemisphere longitude, you must include the hemisphere letter (S or W) or a minus sign (-). The hemisphere letter or plus sign is optional for Northern or Eastern hemisphere positions.</p> <p>TIP — The symbols for degrees (°), minutes ('), and seconds (") can be omitted or replaced with a space, but you must include the decimal point (.).</p>
Longitude	<p>The longitude of the reference position. The formats you can use are as for the Latitude field. This field only appears if the current coordinate system is Lat/Long.</p>
North	<p>The northing of the reference position, in the coordinate units specified in the Coordinate System form. This field only appears if the current coordinate system uses North/East.</p>
East	<p>The easting of the reference position, in the coordinate units specified in the Coordinate System form. This field only appears if the current coordinate system uses North/East.</p>
Altitude	<p>The altitude of the reference position. The altitude is expressed as a Height Above Ellipsoid or Mean Sea Level, depending on the option configured in the Coordinate System form, and is in the altitude units specified in this form.</p>

Collect Features

- Buttons
- Fields
- Options

To open the Collect Features subsection, tap the Subsection list button and select Collect Features. The Collect Features screen appears.

NOTE — This subsection is only available when a file is open. Use the **New File screen** to open a new data file, or the **Existing File screen** to open an existing data file.

Use this form to select a feature type to add. To add a feature, select it from the Choose Feature list and tap **Create**. An **Attribute entry form** appears.

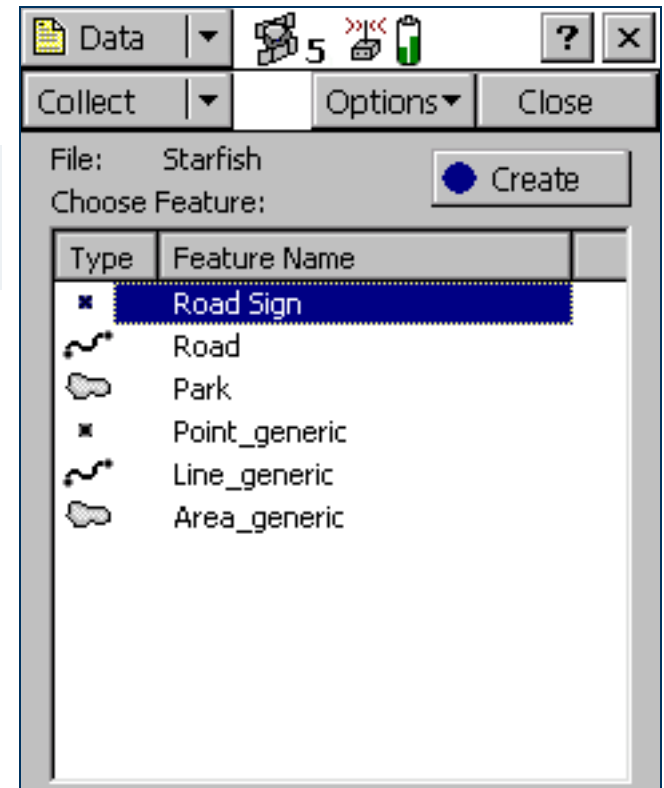

Collect Features form: Buttons

Button	Description
Create	Adds a new feature of the selected type. When you tap Create , the Attribute entry form for the selected feature in the Choose Feature list appears. TIP — The Map screen also has a Create Feature button.

Collect Features form: Fields

Field	Description
File	The filename of the open file. This field is read-only.
Choose Feature list	The feature types in the data dictionary. Select the type of feature you want to create. The list contains the following columns: <ul style="list-style-type: none">• Type The type of feature, indicated by the line or area icon, or the point symbol configured in the data dictionary.• Name The name of the feature.

Collect Features form: Options

Option	Description
Logging interval	Opens the Logging interval form . Use this form to configure the logging interval for all features of the selected type in the open data file.
Repeat	Sets the default attribute values for each new feature to the same values you entered for the last feature of that type. This overrides any default values set in the data dictionary. The Repeat option lets you record a series of similar features quickly and efficiently. You can change any of the attributes of the current feature or simply accept the repeated values. When Repeat is selected, a check mark (✓) appears beside it in the option list. When Repeat is not selected, attributes for new features use the default values set in the data dictionary, if any. For more information, see Repeating features .

Collect Features form: Options (Continued)

Option	Description
Log Now	<p>Configures the software to log positions for a new feature as soon as you begin the feature. You can pause and resume logging at any time.</p> <p>When Log Now is selected, a bullet (•) appears beside it in the option list.</p>
Log Later	<p>Pauses logging of positions for a new feature until you tap Log in the attribute entry form. The pause icon flashes in the Status bar when logging is paused.</p> <p>When Log Later is selected, a bullet (•) appears beside it in the option list.</p>
Trigger <sensor name>	<p>Sends a data request to the sensor. If the sensor is configured to fill in an attribute value, the specified attribute's value is updated with the sensor message.</p> <p>NOTE — This field only appears if the sensor is configured to provide data when requested. To do this, in the Sensor Properties form set the Receive Mode field to Requested, and set the Request Intervals field for the feature type to Trigger.</p> <p>NOTE — This field does not appear in the TerraSync Standard edition software.</p>
Continue	<p>Resumes logging a line or area feature that you logged previously. You can stop logging a line or area feature, record other features on or near it, and then use Continue to return to logging the line or area feature without beginning a new feature.</p> <p>Select the Continue option to open the Continue feature form. Use this form to select a feature to continue. When you select a feature, the attribute entry form for the last line or area feature you logged opens, and logging resumes from the last position. In the line or area feature, the last position logged and the new positions are joined up automatically.</p> <p>For more information, see Continuing line and area features.</p>

Collect Base Data

- Buttons
- Fields
- Options

To open the Collect Base Data screen, tap the Subsection list button and select Collect.

NOTE — This screen is only available when a base file is open. Use the **New File screen** to open a new base file.

Use this form to monitor the status of the open base file, or to change the base station logging settings.

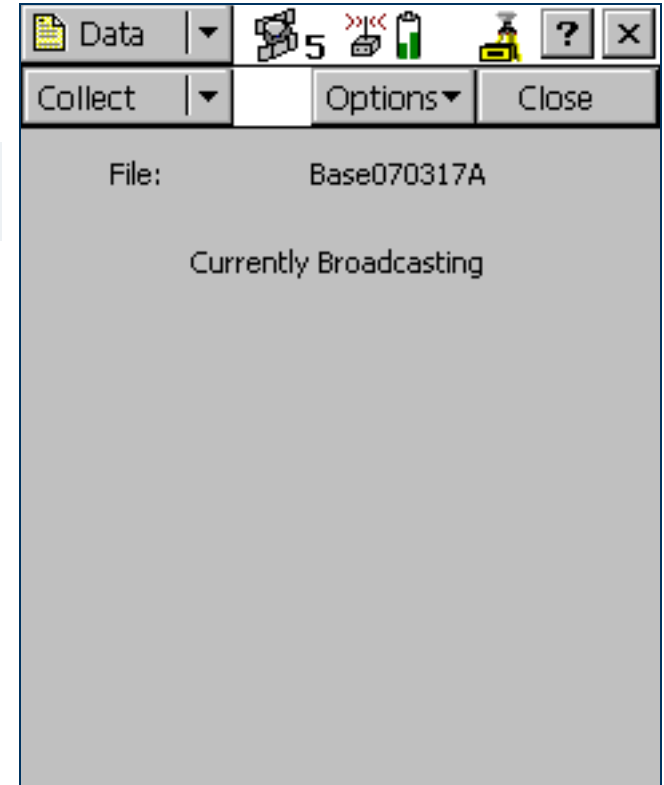

Collect Base Data screen: Buttons

Button	Description
Options	Opens the option list for this form. For a detailed list of the available options, see Options .
Close	Closes the current base file and returns to the New File screen .

Collect Base Data screen: Fields

Field	Description
File	The filename of the open file.
Start	The time and date when the base file was opened.
Duration	The duration, in hours, minutes, and seconds, of the current base data logging session. NOTE — If the receiver is a 5700 or 5800 receiver, the Start and Duration fields show N/A. These receivers can be used only to generate corrections, not to log a base file.

Collect Base Data screen: Options

Option	Description
Base Settings	Opens the Base file logging settings form . Use this form to configure the logging interval and GPS settings for the open base file.

Base file logging settings form

To open the Base file logging settings form, in the **Collect Base Data screen** tap Options, and then select the Base Settings option.

Use this form to change the logging interval and GPS settings for the base data file that you are logging.

The fields on this form are the same fields that appear in the **Logging and GPS Settings step** of the Base Station Setup wizard.

You can also open this form by tapping the Setup button in the **Skyplot screen** or **Satellite information screen**. However, if this form is already open, you cannot use the **Logging Settings** or **GPS Settings** buttons in the **Setup section**.

The screenshot shows a mobile application interface for configuring logging settings. At the top, there is a header bar with a 'Data' dropdown menu, a 'Collect' dropdown menu, and system icons including signal strength, the number '5', a battery level indicator, and a close button. Below the header, the main content area is titled 'Base file logging settings.' and contains three buttons: 'Back', 'Next', and 'Cancel'. Underneath the buttons, the text 'Enter your logging interval and GPS mask settings' is displayed. The 'Logging interval:' is set to '5s'. The 'DOP Type:' is 'PDOP', 'Max PDOP:' is '99.0', 'Min SNR:' is '0.0', and 'Min Elevation:' is '0°'.

Attribute entry form

- [Buttons](#)
- [Fields](#)
- [Options](#)

Use the attribute entry form to enter attribute values for a new feature. To add a new feature, select the feature type from the Choose Feature list in the [Collect Features screen](#) and tap **Create**.

To enter a value for an attribute, select the attribute field. The method of data entry you use will depend on the availability of physical or virtual keyboards, and on the type of field selected. When you have finished entering data in a field, select another field. Alternatively, use the Enter key on the physical or virtual keyboard to move to the next field. For more information on data entry techniques, see [Data entry fields](#).

When you have finished entering attribute data and collecting positions, tap **OK**. The feature is stored and you are returned to the Collect Features screen.

TIP — You can also use the End Feature button in the Map screen to close the current feature.

To discard the new feature, tap **Cancel**. You are prompted to confirm that you want to abandon changes. If you tap **Yes**, the feature, including all its attributes and positions, is discarded.

This form also appears when you update an existing feature. For more information, see [Attribute entry form for existing features](#).

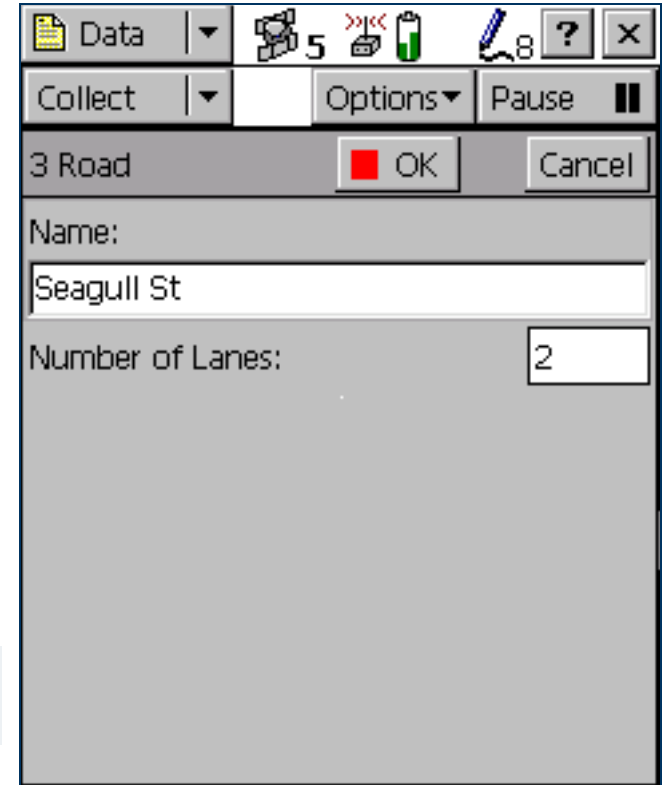

The screenshot shows the 'Attribute entry form' for a '3 Road' feature. The form has a title bar with '3 Road' and 'OK' and 'Cancel' buttons. Below the title bar, there are two input fields: 'Name:' with the text 'Seagull St' and 'Number of Lanes:' with the value '2'. The form is overlaid on a map screen, which is partially visible at the top and bottom. The top of the map screen shows a toolbar with 'Data', 'Collect', 'Options', and 'Pause' buttons, along with various icons like a battery, signal strength, and a question mark. The bottom of the map screen shows a toolbar with 'OK' and 'Cancel' buttons.

Attribute entry form: Buttons

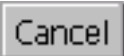
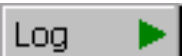
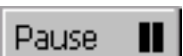
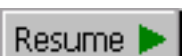
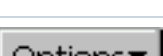
Button		Description
	OK	Closes and saves the current feature and returns to the Collect Features screen .
	Cancel	Returns to the Collect Features screen without saving the current feature.
	Log	Starts logging GPS positions.
	Pause	Suspends logging of GPS positions. For more information, see Pausing and resuming logging .
	Resume	Starts logging GPS positions again after you have pausing logging. For more information, see Pausing and resuming logging .
	Options	Opens the option list for this form. For a detailed list of the available options, see Options .

Attribute entry form: Fields

Field	Description
Mark as updated	Select this check box to indicate that you have visited a feature and checked its position and attributes, without making any changes to the values stored. This field only appears if you are updating an existing feature that has been imported from GPS Pathfinder Office. It is not available if you are creating or updating a new feature.
Attribute fields	The attribute entry form includes a field for each attribute defined in the data dictionary for this feature type.

Attribute entry form: Options

Option	Description
Offset	If a line or area feature is open, this option opens the Offset form . Use this form to enter or edit the offset for the selected feature. If a point feature is open, this option opens the Point offset type form . Use this form to choose what type of offset to record for the selected point feature.
New Vertex	Opens the Vertex form . Use this form to record an averaged vertex for the selected line or area feature.
Logging Interval	Opens the Logging interval form . Use this form to change the logging interval for the selected feature type.
Segment Line	Segments the current line feature. This ends the current line feature and immediately starts a new feature of the same type. The first position of the new feature and the last position of the old feature are at the same location, which is a position recorded when you select the Segment Line option. For more information, see Segmenting line features .
Trigger <sensor name>	<p>Sends a data request to the sensor. If the sensor is configured to fill in an attribute value, the specified attribute's value is updated with the sensor message. Otherwise, an uninterpreted sensor data record is added to the data file.</p> <p>NOTE — This field only appears if the sensor is configured to provide data when requested. To do this, in the Sensor Properties form set the Receive Mode field to Requested, and set the Request Intervals field for the feature type to Trigger.</p> <p>NOTE — This field does not appear in the TerraSync Standard edition software.</p>
Log	Starts logging GPS positions.
Pause	Suspends logging of GPS positions.
Resume	Starts logging GPS positions again after you have pausing logging.

Pausing and resuming logging

When the TerraSync software is logging GPS positions, the logging icon appears in the status bar. Tap **Pause** to pause logging. While paused, TerraSync stops logging GPS positions and the pause icon flashes over the logging icon in the status bar.

When GPS logging is paused, the TerraSync software does not record GPS positions. However, if carrier logging is enabled, background logging of carrier data does continue.

Use the pause function if you want to stop logging briefly. For example, you could pause logging if you are collecting a line feature and you want to stop and enter attribute values, or you have to travel around an obstacle before returning to the line.

To resume logging GPS, tap **Resume**. The pause icon stops flashing and the logging icon appears again. Each time you resume logging while collecting a line or area feature, the TerraSync software immediately logs a GPS position (regardless of the logging interval that you have set for line/area features).

TIP – You can also start, pause, and resume logging from the Map section. For more information, see [Controlling logging from the Map section](#).

Offset form

- **Fields**

When you select the Offset option in the **Attribute entry form** for a line or area feature, the Offset form appears.

Recording an offset lets you log accurate position information for a feature without traveling over it. For example, to record a road centerline, it is safest to walk beside the road at a constant distance from the centerline.

TIP — You can use a **laser rangefinder** to record offsets. For more information, see [Using a laser rangefinder to record offsets](#).

NOTE — You can only enter one offset for each feature you collect.

The screenshot shows a mobile application interface for recording an offset. At the top, there is a toolbar with icons for 'Data', 'Collect', 'Pause', and other functions. Below the toolbar, the form is titled 'Offset for 3 Road'. It contains three main input fields: 'Direction' with a dropdown menu set to 'Left', 'Horizontal distance' with a text input field containing '0.00 m', and 'Vertical distance' with a text input field containing '0.00 m'. At the bottom of the form, there are 'OK' and 'Cancel' buttons.

Offset form: Fields

Field	Description	Default
Direction	<p>The direction the feature lies in, relative to your path of travel. The options are:</p> <ul style="list-style-type: none">• Left• Right <p>For example, if you travel clockwise around a building, the feature you are logging is to the right of the path you are traveling, so select Right.</p>	(none)
Horizontal distance	<p>The two-dimensional distance to the feature. The horizontal distance ignores any difference in height between your position and the feature.</p> <p>This field only appears if the Offset Format is set to Horizontal/Vertical.</p>	0.00 m
Vertical distance	<p>The vertical distance between your position and the feature.</p> <p>This field only appears if the Offset Format is set to Horizontal/Vertical.</p>	0.00 m
Slope distance	<p>The distance from your position to the feature, including any difference in height.</p> <p>This field only appears if the Offset Format is set to Slope distance.</p>	0.00 m
Inclination	<p>The angle of inclination between your position and the feature.</p> <p>This field only appears if the Offset Format is set to Slope distance.</p>	0.00°

Point offset type form

When you select the Offset option in the **Attribute entry form**, and the selected feature is a point feature, the Point offset type form appears. Use this form to specify the type of offset to record. Select an option and tap **Next** to open the corresponding form. The options are:

- **Distance-Bearing Offset form**
- **Distance-Distance Offset form**
- **Triple Distance Offset form**
- **Bearing-Bearing Offset form**
- **Triple Bearing Offset form**

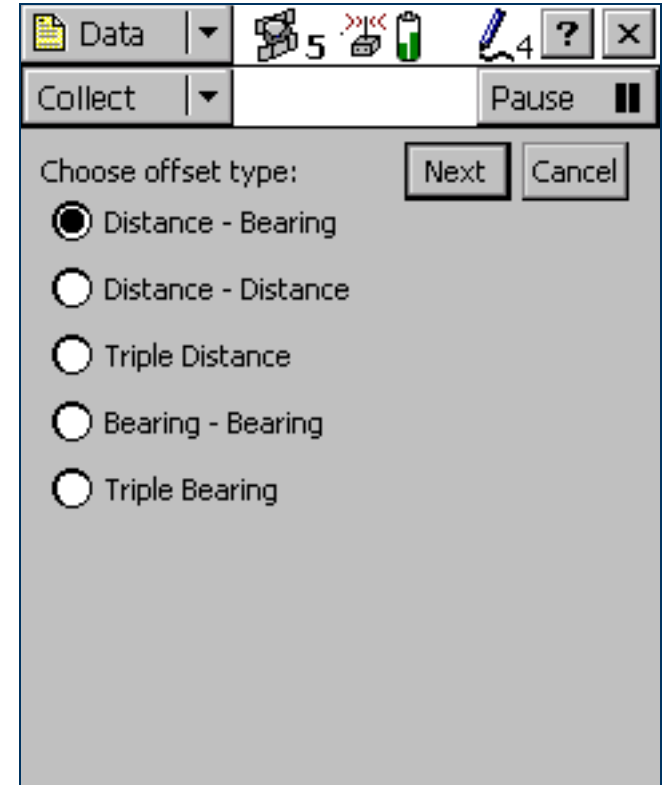

The screenshot shows a mobile application interface for selecting an offset type. At the top, there is a status bar with icons for 'Data', a signal strength indicator (5), a battery level indicator, a pen icon (4), a help icon (?), and a close icon (X). Below the status bar is a 'Collect' dropdown menu and a 'Pause' button with a double vertical bar icon. The main content area is titled 'Choose offset type:' and contains six radio button options: 'Distance - Bearing' (selected), 'Distance - Distance', 'Triple Distance', 'Bearing - Bearing', and 'Triple Bearing'. To the right of the options are two buttons: 'Next' and 'Cancel'.

Distance-Bearing Offset form

- **Fields**

When you select the Distance-Bearing option in the **Point offset type form**, the Distance-Bearing Offset form appears.

When you set a distance-bearing offset, you specify a distance and a bearing from north. The feature lies at the point where the bearing line intersects the circle with the specified distance as its radius.

To specify a distance-bearing offset, fill in the fields on this form and tap **OK**.

The screenshot shows a mobile application interface for setting a distance-bearing offset. At the top, there is a status bar with icons for signal strength, battery, and location. Below this is a header bar with a 'Data' dropdown menu and a 'Collect' dropdown menu. The main title of the form is 'Offset for 5 Road Sign'. Below the title are two buttons: 'OK' and 'Cancel'. The form contains three input fields: 'Bearing (T)', 'Horizontal distance: 0.00 m', and 'Vertical distance: 0.00 m'.

Distance-Bearing Offset form: Fields

Field	Description	Default
Bearing	The bearing, in the selected angle units, from the reference position to the point feature you are logging. For example, if you are facing North and the feature is directly to your right (East), enter 90°. The angle you enter is relative to the configured north reference, which is indicated by a T (true north) or M (magnetic north) after the field name. To configure the north reference, use the Units form .	0.00°
Horizontal distance	The two-dimensional distance to the feature, ignoring any difference in height between your position and the feature. This field only appears if the Offset Format is set to Horizontal/Vertical.	0.00 m
Vertical distance	The vertical distance between your position and the feature. This field only appears if the Offset Format is set to Horizontal/Vertical.	0.00 m
Slope distance	The distance from your position to the feature, including any difference in height. This field only appears if the Offset Format is set to Slope/Inclination.	0.00 m
Inclination	The angle of inclination between your position and the feature. This field only appears if the Offset Format is set to Slope/Inclination.	0.00°

Distance-Distance Offset form

- Buttons
- Fields

When you select the Distance-Distance option in the **Point offset type form**, the Distance-Distance Offset form appears.

When you set a distance-distance offset, you record two reference positions, and the distance from each of these positions to the feature. For more information, see **Distance-distance offset**.

To increase accuracy, you can record each reference position as if it were an averaged vertex. If you log a number of positions at each reference point, TerraSync averages these positions to give a more accurate reference position.

To record the offset, you need to perform a number of steps in a particular sequence. To ensure that the correct steps are followed, the form displays instructions and hides some fields until you have performed the preceding steps. For more information, see **Offsets**.

The screenshot shows the 'Distance - Distance offset for 6 Road Sign' form. At the top, there is a toolbar with icons for 'Data', a camera, a battery level indicator, a pause button, a help button, and a close button. Below the toolbar are buttons for 'Collect', 'Options', and 'Resume'. The main area of the form contains the following text and fields:

Distance - Distance offset for 6 Road Sign

Move to a suitable location and begin logging reference position 2.

Next Clear

Reference position 1 Collected

Distance A

Horizontal distance: 4.68 m

Vertical distance: 0.13 m

Reference position 2 Not started.

Distance-Distance Offset form: Buttons

Button	Description
Next	Moves to the next step in the sequence. When you have completed all steps, this button is replaced with the OK button.
Clear	Deletes all the offset and position data that you have recorded for this feature.

Distance-Distance Offset form: Fields

Field	Description	Default
Reference position	<p>The status of the reference position. This field is read-only, and is repeated for each reference position. The options are:</p> <ul style="list-style-type: none">• Not started You have not yet collected any positions, because logging was paused when you opened the form.• Logging TerraSync is logging positions for this reference position.• Paused Logging of positions is paused.• Collected The position has been collected.	(none)
Distance	<p>The distance from the reference position to the feature. Depending on the current Offset Format, the fields below this heading are either Horizontal distance and Vertical distance, or Slope distance and Inclination. The fields are repeated for each reference position.</p>	(none)
Direction	<p>The feature's direction relative to the path between the reference positions. The options are:</p> <ul style="list-style-type: none">• Left• Right	?

Triple Distance Offset form

- Buttons
- Fields

When you select the Triple Distance option in the **Point offset type form**, the Triple-Distance Offset form appears.

When you set a triple distance offset, you record three reference positions (A, B, and C), and the distance from each of these positions to the feature. A triple distance offset is similar to a distance-distance offset, but a third measurement provides some mathematical redundancy so that the direction can be calculated automatically. For more information, see **Triple distance offset**.

To increase accuracy, you can record each reference position as if it were an averaged vertex. If you log a number of positions at each reference point, TerraSync averages these positions to give a more accurate reference position.

To record the offset, you need to perform a number of steps in a particular sequence. To ensure that the correct steps are followed, the form displays instructions and hides some fields until you have performed the preceding steps. For more information, see **Offsets**.

The Triple Distance Offset form contains the same controls as the **Distance-Distance Offset form**, except that the repeated fields appear three times (for the three reference positions A, B, and C), and the Direction field is usually read-only because the software calculates it automatically.

The screenshot shows the Triple Distance Offset form in the TerraSync software. The form is titled "Triple Distance offset for 6 Road Sign". It contains the following fields and controls:

- Collect** (dropdown menu)
- Options** (dropdown menu)
- Resume** (button)
- Next** (button)
- Clear** (button)
- Horizontal distance:** 0.00 m
- Vertical distance:** 0.00 m
- Reference position 3** (status: Collected)
- Distance C**
- Horizontal distance:** 0.00 m
- Vertical distance:** 0.00 m

Bearing-Bearing Offset form

- Buttons
- Fields

When you select the Bearing-Bearing option in the **Point offset type form**, the Bearing-Bearing Offset form appears.

When you set a bearing-bearing offset, you record two reference positions (A and B), and the bearing from north from each of these positions to the feature. For more information, see **Bearing-bearing offset**.

To increase accuracy, you can record each reference position as if it were an averaged vertex. If you log a number of positions at each reference point, TerraSync averages these positions to give a more accurate reference position.

To record the offset you need to perform a number of steps in a particular sequence. To ensure that the correct steps are followed, the form displays instructions and hides some fields until you have performed the preceding steps. For more information, see **Offsets**.

Bearing - Bearing offset for 6 Road Sign	
Enter the bearing from reference position 2 to the feature.	
<input type="button" value="Next"/> <input type="button" value="Clear"/>	
Reference position 1	Collected
Bearing A	
Bearing (T)	<input type="text" value="56.00°"/>
Reference position 2	Collected
Bearing B	
Bearing (T)	<input type="text" value="56.00°"/>

Bearing-Bearing Offset form: Buttons

Button	Description
Next	Moves to the next step in the sequence. When you have completed all steps, this button is replaced with the OK button.
Clear	Deletes all the offset and position data that you have recorded for this feature.

Bearing-Bearing Offset form: Fields

Field	Description	Default
Reference position	The status of the reference position. This field is read-only, and is repeated for each reference position. The options are as for the Reference position field on the Distance-Distance Offset form .	(none)
Bearing	The bearing, in the selected angle units, from the reference position to the feature. This field is repeated for each reference position. For example, if you are facing north and the feature is directly to your right (east), enter 90°. The angle you enter is relative to the configured north reference, which is indicated by a T (true north) or M (magnetic north) after the field name. To configure the north reference, use the Units form .	0.00°

Triple Bearing Offset form

- Buttons
- Fields

When you select the Triple Bearing option in the **Point offset type form**, the Triple Bearing Offset form appears.

When you set a triple bearing offset, you record three reference positions (A, B, and C), and the bearing from north from each of these positions to the feature. A triple bearing offset is similar to a bearing-bearing offset, but a third measurement provides some mathematical redundancy that can improve accuracy. For more information, see **Triple bearing offset**.

To increase accuracy, you can record each reference position as if it were an averaged vertex. If you log a number of positions at each reference point, TerraSync averages these positions to give a more accurate reference position.

To record the offset you need to perform a number of steps in a particular sequence. To ensure that the correct steps are followed, the form displays instructions and hides some fields until you have performed the preceding steps. For more information, see **Offsets**.

The Triple Bearing Offset form contains the same buttons and fields as the **Bearing-Bearing Offset form**, except that the repeated fields appear three times (for the three reference positions A, B, and C).

Triple Bearing offset for 6 Road Sign	
Remain stationary	Next Clear
Reference position 1	Collected
Bearing A	
Bearing (T)	34.00°
Reference position 2	Collected
Bearing B	
Bearing (T)	45.00°
Reference position 3	Logging

Vertex form

When you select the New Vertex option in the **Attribute entry form**, the Vertex form appears.

The Vertex form looks exactly like the **Attribute entry form**, except that the messages **Vertex # open** (where # represents the vertex number within the current feature) and **Remain stationary** appear in the form title.



When you log an averaged vertex for a line or area feature in **autonomous** or **DGPS** mode, the TerraSync software records several positions at each vertex, then averages these positions to calculate the vertex position. The averaged position is more accurate than a single position. When you log a vertex in **RTK** mode, TerraSync records only the RTK-corrected position with the best precision. All other positions are discarded.

TIP — If you want a line or area feature to contain only vertices, use the **Log Later** function to pause logging before opening the feature. When you open the Vertex form, logging resumes automatically. When you close the vertex, logging returns to the paused state. This ensures that you do not record any positions that are not associated with a vertex.

For more information, see **Recording averaged vertices**.

The screenshot shows the Vertex form interface. At the top, there is a toolbar with icons for Data, Collect, Options, and Pause. The main title bar displays 'Vertex 1 open' and 'Remain stationary'. Below the title bar, the feature name '7 Road' is shown. The 'Name' field is filled with 'Mariner Ave' and the 'Number of Lanes' field is filled with '2'. There are 'OK' and 'Cancel' buttons at the bottom right of the form.

To record a vertex:

1. Open the attribute entry form.
2. Tap **Options**.
3. Select **New Vertex**. The logging icon in the status bar changes to show that you are logging a vertex:
 - In autonomous or DGPS mode, the logging icon changes to an animated circle zooming in , and the number beside it shows the number of positions logged for this vertex.
 - In RTK mode, the logging icon changes to an animated circle zooming in over a triangle . The number beside the icon is 1 if a position has been logged, or 0 if no positions with the required precision have been received yet.
4. Remain stationary at your current location, and enter or edit attribute values if necessary.
5. When you have recorded enough positions for this vertex, tap **OK**. The Vertex form closes, and you are returned to the attribute entry form.

TIP — In RTK mode, you can finish logging the vertex at any time, provided the number beside the logging icon is 1.

Logging interval form

- **Fields**

You can open the Logging interval form from any of the following screens:

- **Collect Features screen**
- **Update Features screen**
- **Attribute entry form** (when logging a new feature)
- **Attribute entry form for existing features** (when updating an existing feature)

The same form appears, regardless of which screen you open it from. Any changes you make apply to the open data file throughout the software.

TIP — The logging interval is only for the highlighted or open feature type. To configure logging intervals for all feature types in the open data file, use the **Logging Settings form** in the Setup section.

To open the Logging interval form, tap **Options** in one of these screens, then select Logging interval.

In this form, you can change the interval for all features of the selected type. A default logging interval for each type of feature is set in the data dictionary.

NOTE — Any changes you make in this form are applied to *all* features of the selected type that you collect or update in the open data file.

The screenshot shows a mobile application interface for configuring logging settings. At the top, there is a title bar with a 'Data' dropdown menu and a 'Collect' dropdown menu. To the right of the title bar are several icons: a 3D model icon, a battery level indicator, and a question mark icon. Below the title bar, there is a 'Park' label, 'OK' and 'Cancel' buttons, and three dropdown menus: 'Logging style:' set to 'Time', 'Logging interval:' set to '5s', and 'Accuracy:' set to 'Code'.

Logging interval form: Fields

Field	Description	Default
Logging style	<p>The unit of measurement for the logging interval. The options are:</p> <ul style="list-style-type: none">• Time Log a new position when a certain time since logging the last position for this feature has elapsed.• Distance Log a new position when you have moved a certain distance from the last position logged for this feature. <p>This field is only available for line and area features. If the selected feature is a point, this field displays Time and the logging style cannot be edited.</p>	Time
Logging interval	<p>The time or distance between recording GPS positions. You must enter the interval in the units specified in the Logging style field.</p> <p>TIP — When the logging interval is small, the TerraSync software records more positions for the feature, but requires more storage space.</p> <p>If you do not want to log positions, select Off. No GPS data is recorded for this feature.</p>	5 s
Accuracy	<p>This field specifies whether to log the usual code phase data from the GPS receiver, or to log more detailed but more accurate carrier phase data.</p>	Code

Continue feature form

- Buttons
- Fields

When you select the Continue option in the **Collect Features screen**, the Continue feature form appears.

This form displays a list of line and area features that can be continued. To continue a feature, select it from the list and tap **Continue**. The **Attribute entry form** for the selected feature appears, and logging of GPS positions to this feature resumes.

For more information, see **Continuing line and area features**.

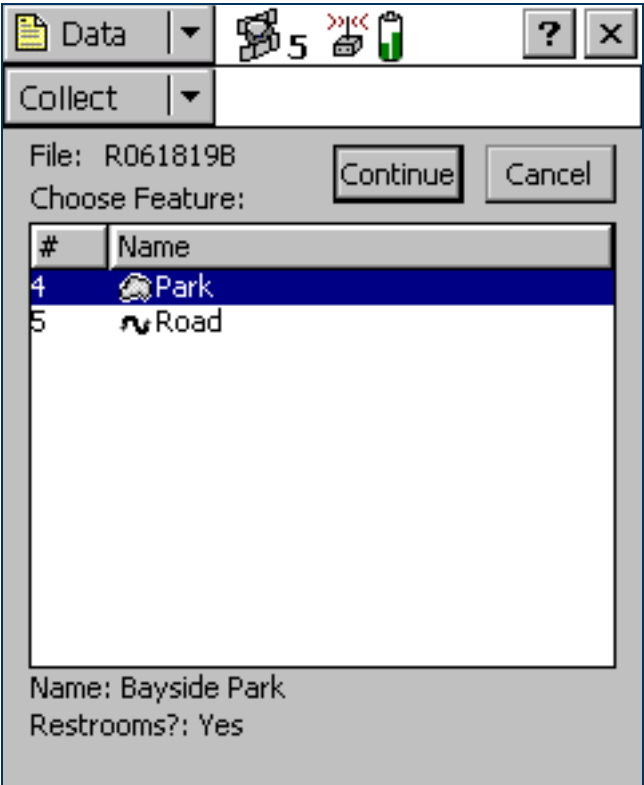

The screenshot shows the 'Continue' feature form. At the top, there is a 'Data' dropdown menu and a 'Collect' dropdown menu. Below these, the file name 'R061819B' is displayed. To the right of the file name are two buttons: 'Continue' and 'Cancel'. Below the buttons is a table with two columns: '#' and 'Name'. The table contains two rows: row 4 with 'Park' and row 5 with 'Road'. The 'Park' row is highlighted in blue. Below the table, the text 'Name: Bayside Park' and 'Restrooms?: Yes' is displayed.

#	Name
4	Park
5	Road

Name: Bayside Park
Restrooms?: Yes

Continue feature form: Buttons

Button	Description
Cancel	Returns to the Collect Features screen without continuing a feature.
Continue	Opens the attribute entry form for the selected feature. Use this form to continue logging positions to the selected feature.

Continue feature form: Fields

Field	Description
File	The filename of the open file. This field is read-only.
Choose Feature list	The list of features that you can review or update. The list contains the following columns: <ul style="list-style-type: none">• # The feature identification number. Each feature is given a unique number in the file.• Name The name of the feature and its type, shown by the line or area icon to the left of the feature name.
Labels	The name and value of two attributes from the selected feature. The data dictionary defines which attributes from each feature type are selected as labels. Use the labels to check that you have selected the correct feature from the list.

Existing File

- Fields

NOTE — You cannot open imported files using the **TerraSync Standard edition software**. Imported files do not appear in the Existing File screen.

To open the Existing File subsection, tap the Subsection list button and choose Existing File.

Use the Existing File subsection to open an existing data file.

When you have selected an existing data file from the list of files, tap **Open** to open this file and begin reviewing existing features in the **Update Features screen**.

NOTE — This section is not available if a file is already open. To access this section, close the open data file.

TIP — You can also switch to the **Collect Features screen** to add new features to the file. However, because of the way in which GPS times are stored, you cannot log new features to a file that is more than a week old. To maintain accurate storage, it is necessary to limit the time-span of a data file to seven days.

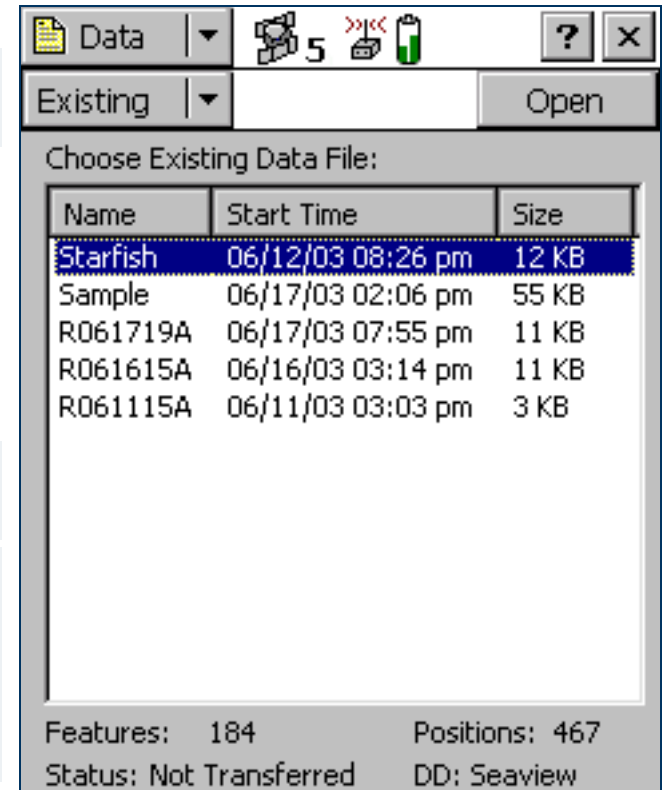

Existing File screen: Fields

Field	Description
List of files	<p>A list of all the data files that are available for update. The list contains the following columns:</p> <ul style="list-style-type: none">• Name The name of the data file.• Time The date and time when the file was created or was last updated.• Size The size of the file. <p>You can drag each column heading to resize the column, or tap a column heading to sort by that column. If the list is already sorted by the column you tap, the sort order reverses.</p> <p>To open a file, highlight it in this list and then tap Open. The Update Features screen appears.</p>
Features	The number of features in the selected file.
Positions	The number of position records in the selected file.
Status	<p>The update status of the selected file. The options are:</p> <ul style="list-style-type: none">• Transferred The file has been created or updated in TerraSync, and then copied to the office computer, and it has not been updated in TerraSync since.• Not Transferred The file has not been copied to the office computer since it was created or last updated.• Imported The file has been transferred from the office computer, imported from Shapefiles, or received by e-mail, but it has not yet been updated in the TerraSync software. <p>NOTE — If you are using the TerraSync Standard edition software, files with the status Imported do not appear in this list, because they cannot be opened.</p>
DD	<p>The data dictionary that the selected file is associated with. When you create a file, you associate it with a particular data dictionary.</p> <p>NOTE — Once you have created a file, you cannot change which data dictionary it uses.</p>

Update Features

- Buttons
- Fields
- Options

NOTE — You cannot open imported files using the **TerraSync Standard edition software**.

To open the Update Features subsection, tap the Subsection list button and select Update Features.

Use this subsection to review and maintain features and attributes you have already collected. You can update attributes, offsets, and GPS positions, or delete features. The Update Features screen lists all the features in the open data file.

To update a feature, highlight it in the Choose Feature list and tap **Begin**. An attribute entry form appears.

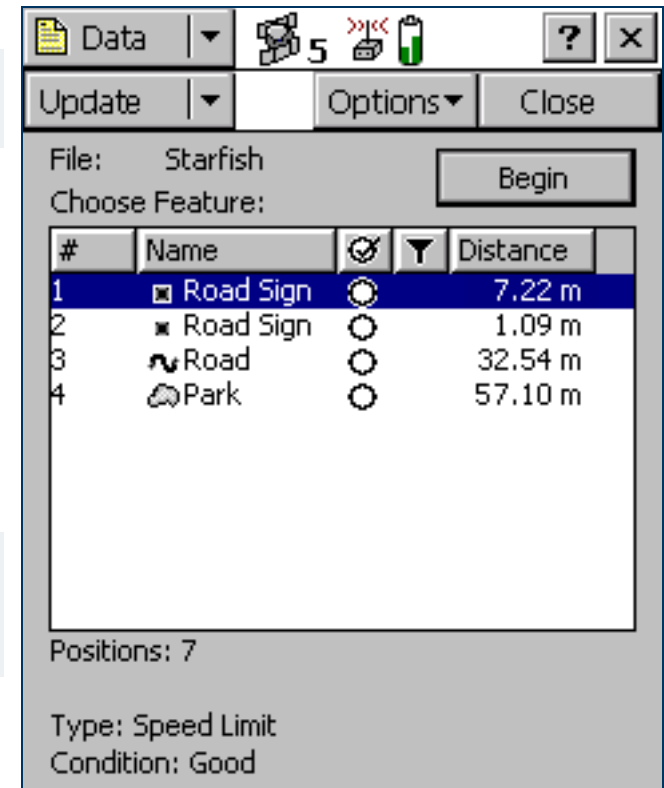

NOTE — This subsection is only available when a file is open. Use the **Existing File screen** to open an existing data file, or the **New File screen** to open a new data file.



Update Features screen: Buttons

Button	Description
Begin	Opens the selected feature on the list for update. When you tap Begin , the attribute entry form for the selected feature appears.









Update Features screen: Fields

Field	Description
File	The filename of the open file. This field is read-only.
Choose Feature list	<p>The list of features that you can review or update. The list contains the following columns:</p> <ul style="list-style-type: none">• # The feature identification number. Each feature is given a unique number in the file.• Name The name of the feature and its type, shown by the point, line, or area icon to the left of the feature name• Update The Update status of the feature:<ul style="list-style-type: none">• (blank) The feature is new.•  The feature has been imported from GPS Pathfinder Office.•  The feature has been updated.• Filter The filter status of the feature:<ul style="list-style-type: none">• (blank) The feature does not meet the criteria of the filter, or no filter has been set.•  The feature meets the filter criteria.• Distance The distance from the feature to the GPS position.
Positions	The number of GPS and digitized positions recorded for the selected feature in the list.



Update Features screen: Fields (Continued)

Field	Description
Carrier coverage	<p>The carrier phase status of the selected feature. This field only appears if the selected feature has carrier phase data collection enabled.</p> <p>Possible values are:</p> <ul style="list-style-type: none">• <carrier time> Enough carrier data has been collected for this feature. This field shows the length of the block, in mm:ss format.• Continuing The carrier block that this feature belongs to is still being collected, and may provide enough carrier data to process this feature.• Insufficient Not enough carrier data has been collected for this feature.
Length (2D)	<p>The two-dimensional length of the selected feature. This field only appears if the selected feature is a line or area feature. The two-dimensional length is calculated by adding together the horizontal distances between positions logged for the feature, ignoring height information.</p>
(3D)	<p>The three-dimensional length of the selected feature. This field only appears if the selected feature is a line feature. The three-dimensional length takes the height of each position in the feature into account when it calculates distances between positions.</p>
Area	<p>The (two-dimensional) area of the feature. This field only appears if the selected feature is an area feature.</p>
Labels	<p>The name and value of two attributes from the selected feature. The data dictionary defines which attributes from each feature type are selected as labels. Use the labels to check that you have selected the correct feature from the list.</p>

Update Features screen: Options

Option	Description
Show Filtered Features	Displays filtered features in the Choose Feature list and on the map. Filtered features are indicated by the filter icon  in the Filter column. When filtered features are displayed, this option has a check mark (✓) beside it.
Show Unfiltered Features	Displays unfiltered features in the Choose Feature list and on the map. Unfiltered features are indicated by a blank in the Filter column. When unfiltered features are displayed, this option has a check mark (✓) beside it.
Filter	Opens the Filter By form . Use this form to set or clear filtering conditions.
Delete	Deletes the selected feature from the Choose Feature list. A deleted feature is indicated by a horizontal line through it. Deleted features can be undeleted in the TerraSync software or in the GPS Pathfinder Office software.
Undelete	Undeletes the selected feature. The line through the feature is removed. This option is only available if the selected feature is deleted.
Set Nav Start	Sets the currently selected feature or GPS position as the navigation start point. When you set the start, the point  , line  , or area  icon beside the selected feature is replaced by the start icon  . If there was already a navigation start selected, that feature's icon changes from the start icon back to its usual point, line, or area icon.
Set Nav Target	Sets the currently selected feature as the navigation target. When you set the target, the point  , line  , or area icon beside the selected feature is replaced by the target icon  . If there was already a navigation target selected, that feature's icon changes from the target icon back to its usual point, line, or area icon.
	TIP – You can also set the navigation start and target in the Map section.

Update Features screen: Options (Continued)

Option	Description
Clear Nav Targets	Clears the navigation start and the navigation target. You can use this option even when the selected feature in the list is not the navigation start or target. When you select this option, the start  and target  icons beside the existing navigation start and target are replaced by the usual point, line, or area icons for those features.
Logging interval	Opens the Logging interval form . Use this form to configure the logging interval for all features of the selected type in the open data file.
Continue	Resumes logging a line or area feature that you logged previously. For more information, see Continuing line and area features .

Attribute entry form for existing features

- Buttons
- Fields
- Options

Use this form to update a feature's attributes or position data. To update a feature, highlight the feature in the Choose Feature list in the **Existing File screen** and tap **Begin**. Alternatively, double-tap the feature in the Map screen.

TIP — To update a feature without changing its attribute values or position information, select the Mark as updated check box. For more information, see **Marking a feature as updated**.

When you have finished editing the attribute data, or have marked the feature as updated, tap **OK**. The updated information is stored and the **Update Features screen** reappears. A check mark  appears next to the feature name in the Choose Feature list. This indicates that the feature has been updated.

To abandon changes to a feature, tap **Cancel**. You are prompted to confirm this cancellation.

Use **Log**, **Pause**, and **Resume** to start, pause, or resume logging of GPS positions. By default, when you update an existing feature, new GPS positions are not logged, so logging is paused when you first open the feature for update. For more information, see **Pausing and resuming logging**.

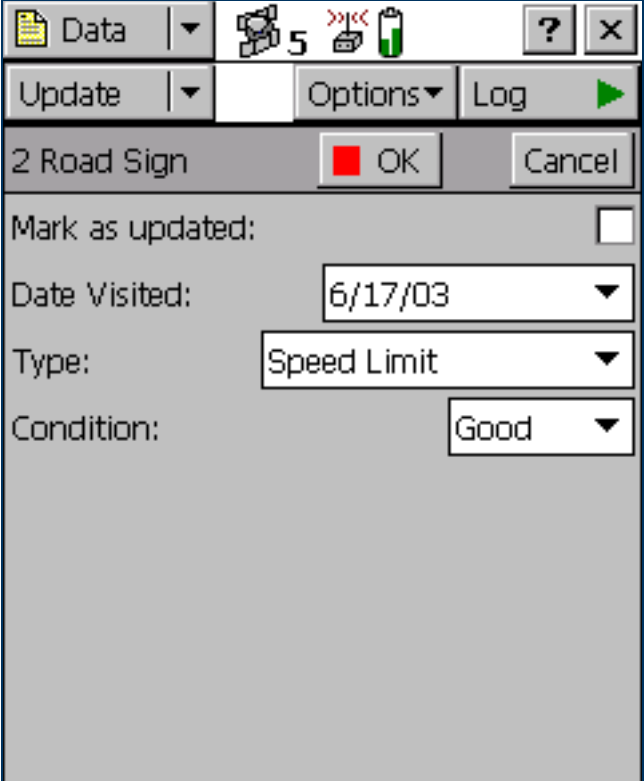



The screenshot shows a mobile application interface for updating a feature. At the top, there is a status bar with icons for Data, signal strength (5), battery, and a close button. Below the status bar is a header with 'Update' and 'Options' buttons, and a 'Log' button with a green play icon. The main content area is titled '2 Road Sign' and contains a red square icon, an 'OK' button, and a 'Cancel' button. Below the title, there are four fields: 'Mark as updated:' with a checkbox, 'Date Visited:' with a dropdown menu showing '6/17/03', 'Type:' with a dropdown menu showing 'Speed Limit', and 'Condition:' with a dropdown menu showing 'Good'.

Update status

Each feature in a data file has an update status. You can use the update status to sort or filter features in the field, so you can tell which features are new, which you have visited for data maintenance, and which you have not visited yet. In the GPS Pathfinder Office software you can use the update status to select features to export to the GIS.

The Update column of the **Choose Feature list** in the **Update Features screen** shows the status of each feature:

Data section: Update status

Icon	Update status	Description
(blank)	New	The feature has been created since the file was transferred from GPS Pathfinder Office, or the feature is in a new file that has never been transferred to GPS Pathfinder Office.
	Imported	The feature has been transferred from GPS Pathfinder Office but has not been updated yet.
	Updated	The feature has been transferred from GPS Pathfinder Office and has been updated since the transfer.

When you change an Imported feature in any way, its update status changes to Updated. Any of the following actions automatically changes a feature's status to Updated:

- Changing attribute values in the **Attribute entry form for existing features**
- **Marking a feature as updated** in the attribute entry form
- **Updating positions** with the **Log** button
- **Digitizing** positions
- Adding or changing **Offsets** in an offset form

NOTE — When you edit a New feature, its status does not change to Updated. The update status indicates the feature's status with respect to GPS Pathfinder Office and the GIS.

Marking a feature as updated

When you change an existing feature's attribute values, offset data, or GPS position, its **Update status** changes to Updated. When you are visiting features for data maintenance, you can use the update status to identify the features you have not visited yet.

Sometimes you may want to indicate that you have visited a feature and checked its position and attributes, without making any changes to the values stored. You can do this by selecting the Mark as updated check box in the attribute entry form. The feature's status changes to Updated and the updated icon (🔄) appears beside it in the **Choose Feature list**.

If the feature has a date attribute that is set in the data dictionary to Auto Generate on Update, the date attribute's value automatically changes to the current date. No other changes to the feature information occur.

TIP – After you have marked a feature as updated, you can still change its attributes or position information as usual. However, once you change attribute values or position information, you cannot unmark the feature.

Updating positions

To update the position information for a feature:

1. Select the feature from the **Choose Feature list** and tap **Begin**. The attribute entry form appears.
2. Tap **Log**.
3. If the **Allow Position Update** field on the **Logging Settings form** is configured to require confirmation, or the feature is a line or area, a message box appears, asking you to select a logging option:

Update Features screen: Logging options

Option	Description
Update feature (Replace)	Records new positions for this feature, replacing all positions.
Continue feature (Append)	Continues the feature, appending the new positions to the existing positions. For more information, see Continuing line and area features . This option is not available for point features.

If you tap **OK** in this message box, TerraSync starts logging GPS data. This data either replaces or is appended to existing positions, depending on the option you selected. If you tap **Cancel**, the message box closes and no GPS data is logged.

4. When you have finished collecting positions for a feature, tap **OK**. The updated information is stored and the **Update Features screen** reappears. The updated icon () appears next to the feature in the Choose Feature list to indicate that it is updated.

NOTE — If you log new or additional position information for a feature while that feature is selected as the navigation target, you must reselect the feature as the navigation target before you can navigate to its new position.

TIP — You can also use **Digitizing** to update a feature's positions.

Filter By form

- **Fields**

When you select the Filter option in the **Update Features screen**, the Filter By form appears.

In this form you can set filters that divide features into two groups: *filtered* and *unfiltered*. Once you have applied a filter, you can hide or show either group in the Data section or in the **Map section**. You can also sort features by their filter status.

NOTE — Any filter that you apply in the Data section applies throughout the TerraSync software while the current data file remains open.

For more information on filtering, see **Filtering features**.

The screenshot shows the 'Filter By' dialog box. At the top, there is a 'Data' dropdown menu and a '5' icon. Below that is an 'Update' dropdown menu. The main area is titled 'Filter By' and contains several options with checkboxes: 'Update Status:' (unchecked), 'Deleted Status:' (unchecked), and 'Features:' (checked). Below these are six rows, each with a feature name and a dropdown menu set to 'Unfiltered': 'Road Sign', 'Road', 'Park', 'Point_generic', 'Line_generic', and 'Area_generic'. At the bottom right, there are 'OK' and 'Cancel' buttons.

Filter By form: Fields

Field	Description
Update Status	<p>Select this check box to filter by update status. If this check box is selected, the following fields appear below it:</p> <ul style="list-style-type: none">• New• Imported• Updated <p>For each field, you can choose one of the following options:</p> <ul style="list-style-type: none">• Unfiltered• Filtered <p>If this check box is cleared, the New, Imported, and Updated fields do not appear, and the filter does not consider update status.</p>
Deleted Status	<p>Select this check box to filter by deletion status. If this check box is selected, the following fields appear below it:</p> <ul style="list-style-type: none">• Deleted• Undeleted <p>For each field, you can choose one of the following options:</p> <ul style="list-style-type: none">• Unfiltered• Filtered <p>If this check box is cleared, the Deleted and Undeleted fields do not appear, and the filter does not consider deletion status.</p>

Filter By form: Fields (Continued)

Field	Description
Features	<p>Select this check box to filter by feature types or their attributes. If this check box is selected, a field for each type of feature in the data dictionary appears below it. Use these fields to specify feature filtering conditions.</p> <p>Each feature type field provides the following options:</p> <ul style="list-style-type: none">• Unfiltered Do not filter by this feature type.• All Filtered Filter all features of this type.• Filter By Select features of this type to filter by, using attribute values. When you select this option, the Attribute, Test, and Value fields appear below it. Use these three fields to select the attribute values for this feature to filter by.
Attribute	<p>The attribute from the feature type to filter by. Each attribute of the feature type is listed here. This field only appears if the Filter By option is selected in the feature type field.</p>
Test	<p>The comparison to perform on the attribute selected above. The options listed depend on the attribute type:</p> <ul style="list-style-type: none">• Menu Equal To, Not Equal To• Text or filename Containing, Not Containing• Date, time, or numeric Equal To, Not Equal To, Less Than, Greater Than <p>This field only appears if the Filter By option is selected in the feature type field.</p>
Value	<p>The attribute value to filter by. If there is a list of options, select an attribute value from the list. Otherwise, enter the value to filter by.</p> <p>This field only appears if the Filter By option is selected in the feature type field.</p>

Filtering features

The TerraSync software lets you filter each feature by one attribute value. However, a filter can include conditions for each feature type, as well as the deletion status or update status of each feature. You can set complex filtering conditions with a single filter, or you can select just one condition to filter.

When you apply a filter, all features are divided into two groups: filtered and unfiltered. The software does not automatically hide or show either group; it is up to you to decide which group you want to view and which, if any, you want to hide.

To define a filter, tap **Options** in the **Update Features screen** (or in the **Map section**) and select Filter. The **Filter By form** appears.

The Filter By form lets you define conditions on each feature's update status, deletion status, and feature type. You can set any or all of these filters. By default, no filtering is applied.

The filter functions like a sieve. All features that satisfy the conditions you specify are moved to the filtered group. The others remain in the unfiltered group. If you want to separate a small group of features from the rest, set them to be filtered.

You can set any or all of these filters at the same time. When you set more than one filtering condition, *all* conditions must be met for a feature to be filtered. For example if you have chosen to filter deleted features that have been updated, a feature must be *both* updated *and* deleted to be included in the filtered group. If it does not meet all the conditions you set, it remains in the unfiltered group.

To set a filter on each feature's update status, select the Update Status check box. The New, Imported, and Updated fields appear below the check box. Select the appropriate value in each field. For example, to filter new and updated features, select Filtered in the New field and selected Filtered in the Updated field.

Similarly, to set a filter on each feature's deletion status, select the Deleted Status check box. The Deleted and Undeleted fields appear below the check box. Select the appropriate value in each field to specify filtering conditions.

To set a filter on feature properties, select the Features check box. A field for each feature type in the data dictionary appears in the Filter By form. By default, each of these fields is set to the Unfiltered option, so no features are selected.

If you select All Filtered from a feature type field, all features of that type are included in the filter. If you select Unfiltered, no features of this type are included. If you select Filter By, you can filter this feature type according to its attribute values.

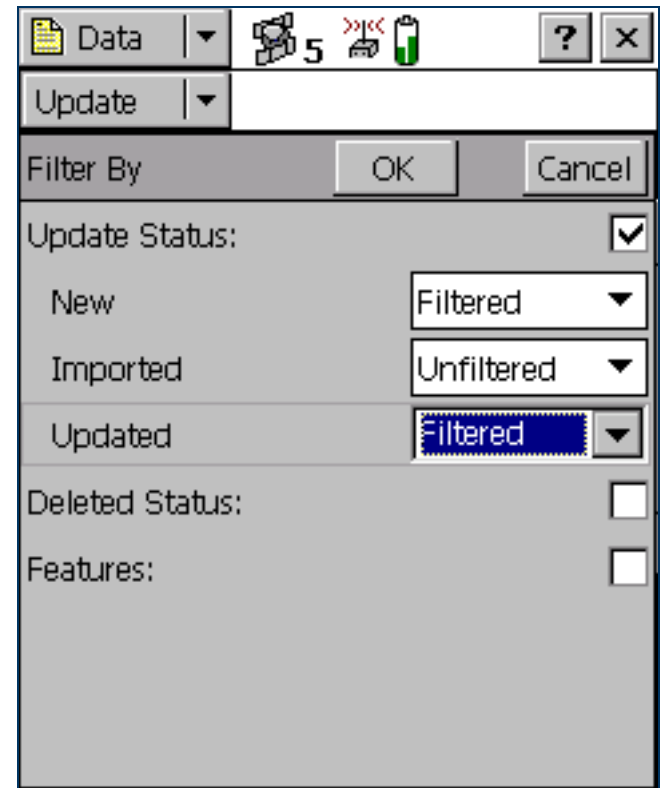

When you select Filter By in a feature type field, the Attribute, Test, and Value fields appear below it. To filter by attribute, select the attribute name in the Attribute field, select a comparison operation in the Test field, and enter or select a value in the Value field.

When you apply the filter, a feature of this type is filtered if the value in the selected attribute matches the value and comparison in the filter. For example, if you specify that the Date Visited attribute must be less than 1 January 2000, any feature visited on or before 31 December 1999 is filtered. Features visited on or after 1 January 2000 remain in the unfiltered group.

You can apply different levels of filtering to different feature types. For example you could select All Filtered for the Road and Park feature types, but specify an attribute condition for the Road Sign feature type. When you apply the filter, all of the Road and Park features, and some of the Road Sign features, are filtered. The remaining Road Sign features are unfiltered.

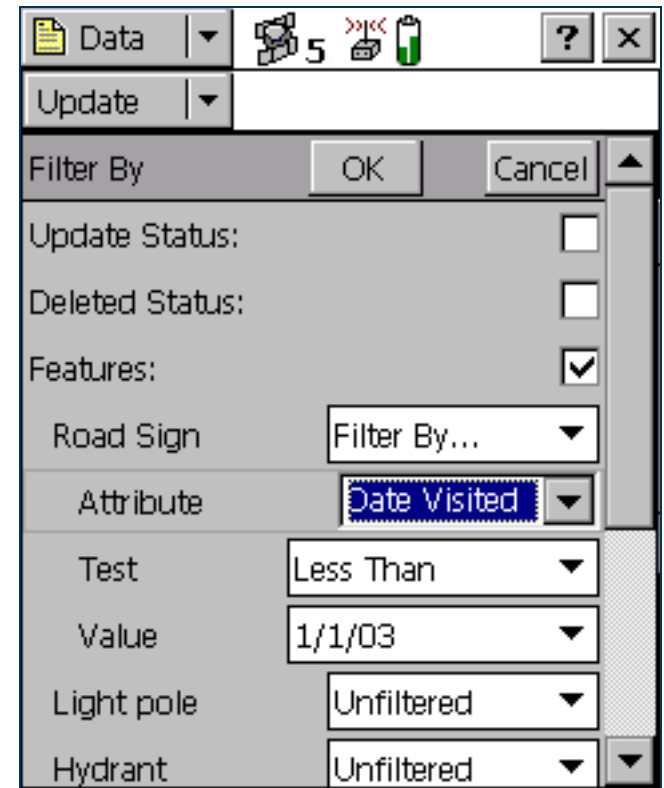

To apply a filter, simply tap **OK** in the Filter By form. The form closes and the filter icon  appears in the **Status bar**. Each feature in the **Update Features screen** that is filtered has a filter icon  beside it. Unfiltered features have no icon.

NOTE — Any filter you use applies as long as the current data file remains open, and is cleared when you close the file.

Once a filter is active, you can tap the Filter column heading to sort the list by filter status. Filtered features are grouped first, followed by unfiltered features. Tap the column heading again to reverse the sort order, listing unfiltered features first.

Use the **Show Filtered Features** and **Show Unfiltered Features** options in the Update Features screen to hide or show the two groups of features. When you hide or show a group of features in the Data section, the corresponding map layer is hidden or shown. Similarly, when you hide or show features in the Map section, they are hidden or shown in the Data section. For more information, see **Map layers**.

NOTE — Deleted features are never displayed on the map.

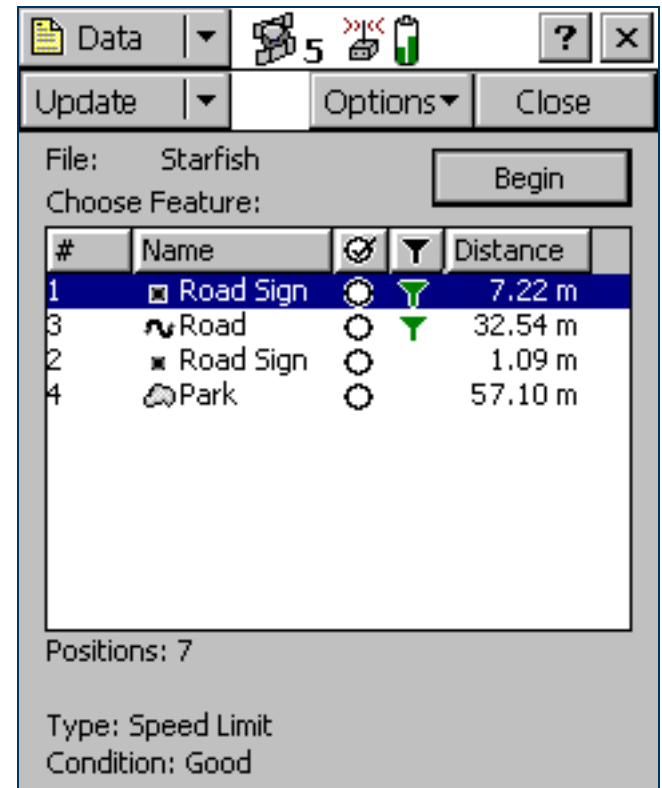

Construct Target Offset form

- **Fields**

When you select Set Nav Target / Construct from the option list in the **Update Features screen**, the Construct Target Offset form appears. In this form, you can set a navigation target by specifying an offset from the current navigation start point.

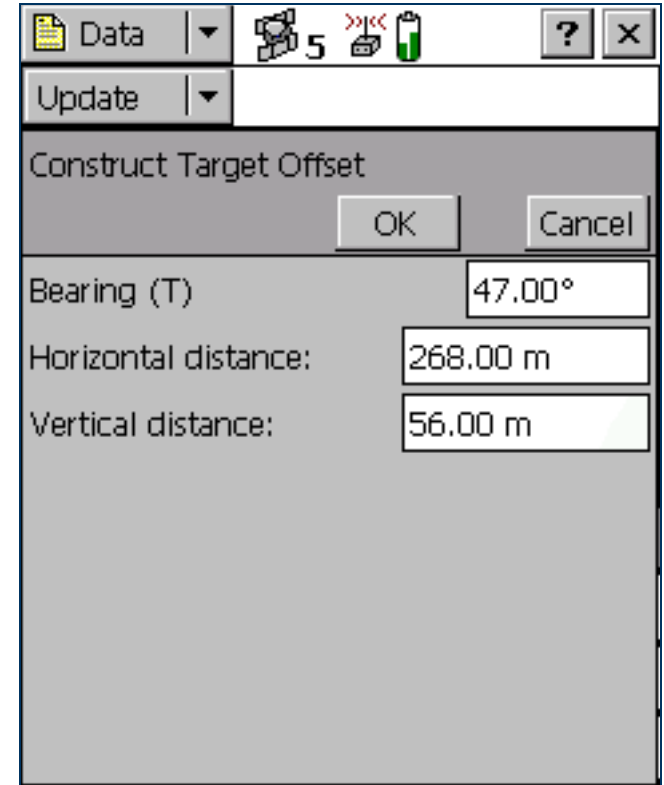

The screenshot shows a handheld device interface with a 'Data' menu at the top left and various status icons (signal strength, battery, etc.) at the top right. Below the menu is an 'Update' dropdown. The main form is titled 'Construct Target Offset' and contains three input fields: 'Bearing (T)' with a value of 47.00°, 'Horizontal distance:' with a value of 268.00 m, and 'Vertical distance:' with a value of 56.00 m. 'OK' and 'Cancel' buttons are located at the top right of the form area.

Field	Value
Bearing (T)	47.00°
Horizontal distance:	268.00 m
Vertical distance:	56.00 m

Construct Target Offset form: Fields

Field	Description
Bearing	The bearing, in the selected angle units, from the navigation start to the target position. The angle you enter is relative to the configured north reference, which is indicated by a T (true north) or M (magnetic north) after the field name. To configure the north reference, use the Units form .
Horizontal distance	The two-dimensional distance from the navigation start to the target position. The horizontal distance ignores any difference in height between the start and target. This field only appears if the Offset Format field is set to Horizontal/Vertical.
Vertical distance	The vertical distance from the navigation start to the target position. This field only appears if the Offset Format field is set to Horizontal/Vertical.
Slope distance	The distance from the navigation start to the target position, including any difference in height. This field only appears if the Offset Format field is set to Slope/Inclination.
Inclination	The angle of inclination between the navigation start and the target position. This field only appears if the Offset Format field is set to Slope/Inclination.

File Manager

- Fields
- Options

To open the File Manager subsection, tap the Subsection list button and select File Manager. You can use this subsection to:

- copy or move files between the main memory and storage cards, or between disk drives
- delete or rename files
- e-mail files
- convert files to or from Shapefile format
- create, extract, or edit data dictionaries

Highlight the file you want, and then tap **Options** to access a list of available **Options** for this screen.

NOTE — The options that are available depend on the selected file type, the TerraSync software edition (Professional or Standard) that is installed, and the storage locations that are available on the field computer.

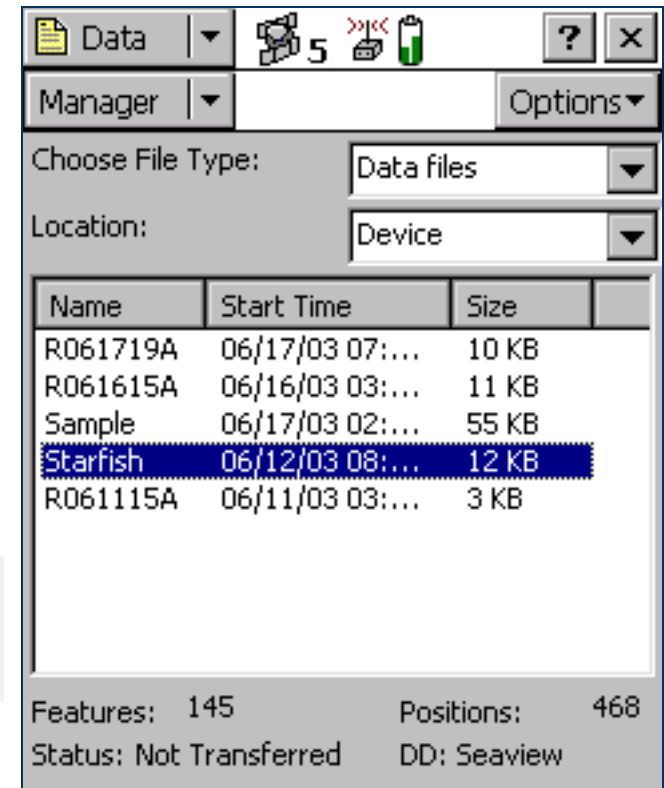

File Manager screen: Fields

Field	Description	Default
Choose File Type	<p>Select the type of file to display. The options are:</p> <ul style="list-style-type: none"> • Data files SSF files (.cor, .imp, .phs, or .ssf files) containing feature and attribute information. • Base files SSF files containing reference base station data. • Dictionaries Data dictionary (.ddf) files containing feature definitions. • Background files Background image files in vector (.cor, .imp, .phs, .ssf) or raster (.bmp, .jpg, .sid, .tif) format. • Geoid files Files containing geoid definitions. • Configuration files .tcf files containing TerraSync configuration information. 	Data files
Location	<p>Select the storage location to display files from. The options are:</p> <ul style="list-style-type: none"> • Device The main memory of the CE device. • Card A storage card connected to the CE device. If you have more than one card connected, there is a numbered option for each card (Card 1, Card 2, and so on). • (Drive letter) A disk drive on the PC. If the PC has more than one writable disk drive, there is an option for each drive (A:, C:, and so on). 	Device <i>or</i> C:

File Manager screen: Fields (Continued)

Field	Description	Default
List of files	<p>The list of files that you can move, copy, rename, delete, or export to Shapefiles. The list contains the following columns:</p> <ul style="list-style-type: none">• Name The name of the file.• Start Time The date and time when the file was created or last updated.• Format The file format of the background file. This column appears instead of the Start Time column when Background files is selected in the Choose File field.• Size The size of the file, in kilobytes. <p>You can drag a column heading to resize the column, or tap a column heading to sort by that column. If the list is already sorted by the column you select, the sort order is reversed.</p>	(no default)
Features	<p>The number of features in the selected file.</p> <p>This field is blank unless the Data files option or the Base files option is selected in the Choose File Type list. If the Base files option is selected, this field shows the value Base.</p>	(no default)
Positions	<p>The number of position records in the file.</p> <p>This field is blank unless the Data files option is selected in the Choose File Type list.</p>	(no default)

File Manager screen: Fields (Continued)

Field	Description	Default
Status	<p>The update status of the selected file. The status is one of the following:</p> <ul style="list-style-type: none"> • Transferred The file has been created or updated in the TerraSync software, has been copied to the office computer, and has not been updated in TerraSync since. • Not Transferred The file has not been copied to the office computer since it was created or last updated. • Imported The file has been transferred from the office computer, imported from Shapefiles, or received by e-mail, but has not yet been updated in TerraSync. • Not Usable The file's status is Imported, but you are using the TerraSync Standard edition software so you cannot update it. 	(no default)
DD	<p>The name of the data dictionary associated with the selected file. This field is blank unless the Data files option or the Dictionaries option is selected in the Choose File Type list</p>	(no default)

File Manager screen: Options

Option	Description
Delete	Deletes the highlighted file.
Copy to Card/A:	<p>Makes a copy of the highlighted file in the main memory or hard drive, and stores that copy on a storage card or removable disk in the field computer.</p> <p>NOTE — The drive letter matches the drive letter of the removable disk. Usually the drive letter is A:.</p> <p>This option is only available if there is a storage card or removable disk in the field computer and you selected Device or C: in the Location field.</p>
Copy to Device/C:	<p>Makes a copy of the highlighted file on the storage card or removable disk, and stores that copy in the main memory or hard drive of the field computer.</p> <p>This option is only available if there is a storage card or removable disk in the field computer, and you selected Card or A: in the Location field.</p>
Rename	Changes the name of the highlighted file.
Move to Card/A:	<p>Moves the highlighted file from the main memory or hard drive to a storage card or removable disk in the field computer.</p> <p>This option is only available if there is a storage card or removable disk in the field computer and you selected Device or C: in the Location field.</p>
Move to Device/C:	<p>Moves the highlighted file from a storage card or removable disk in the field computer to the main memory or hard drive.</p> <p>This option is only available if there is a storage card or removable disk in the field computer and you selected Card or A: in the Location field.</p>
Send via E-mail	Opens the Send via E-mail form .
Receive via E-mail	Opens the Receive via E-mail form .

File Manager screen: Options (Continued)

Option	Description
Edit dictionary	Opens the Edit dictionary form . Use this form to update the selected data dictionary, or to update the data dictionary that is embedded in the selected data file. If you edit a data dictionary, the changes affect all data files that you create using this data dictionary. Changes do not affect data files already created using this data dictionary. If you edit a data file's <i>embedded</i> dictionary, the changes affect only this data file, not the data dictionary that was used when the file was created.
New dictionary	Opens the New dictionary form . Use this form to specify a name for the new data dictionary.
Read dictionary from data	Opens the Read dictionary from data form .
Read data from Shape	Opens the Read from Shape form . The name of this option and the name of the form depend on the file type that is selected in the Choose File field.
Write data to Shape	Opens the Write to Shape form .

Send via E-mail form

- Fields

NOTE — This option is only available on field computers that have e-mail support.

When you select the Send via E-mail option from the options list in the **File Manager screen**, the Send via E-mail form appears.

In this form you can specify the recipient and the subject line for an e-mail. When you tap **OK**, an e-mail, with the selected file attached to it, is automatically generated and sent to your e-mail program's outbox. The next time you connect to your selected e-mail service, the e-mail is sent to the address you specified.

On a CE device, you can use different e-mail services to send data files from the TerraSync software. The default service used is synchronization with a desktop computer. However, you can set up services for connection via a network, cellphone, or modem.

NOTE — To successfully send and receive files from within TerraSync, the e-mail service that you use must specify the login details for connecting to your ISP, and must be configured to download the entire message and any attachments, not just the message header.

For more information on adding and configuring services, refer to the help for your e-mail program.

NOTE — The only file types that the TerraSync software can send by e-mail are data files and data dictionary files.

The screenshot shows a mobile application interface for sending an email. At the top, there is a status bar with icons for 'Data', signal strength, battery, and a close button. Below the status bar is a 'Manager' dropdown menu. The main form is titled 'Send via E-mail' and has 'OK' and 'Cancel' buttons. The form contains the following fields: 'To:' with the value 'gis@seaview.gov', 'Subject Prefix:' with the value 'Trimble File:', 'Service:' with a dropdown menu set to 'ActiveSync', and 'Delete after send:' with an unchecked checkbox.

Send via E-mail form: Fields

Field	Description
To	<p>The e-mail address you want to send the selected file to.</p> <p>If you have sent files from the TerraSync software before, this field defaults to the last e-mail address you used.</p>
Subject Prefix	<p>A subject line for the e-mail.</p> <p>If you have sent files from the TerraSync software before, this field defaults to the last subject line you used.</p>
Service	<p>The e-mail service to use when sending the message. This field lists all the services that you have defined in your e-mail program.</p> <p>By default, the ActiveSync service is selected. The ActiveSync service synchronizes the field computer's outbox with the desktop computer's outbox. The next time the desktop computer connects to the Internet, the e-mail program sends the e-mails in its outbox.</p> <p>This field only appears if the field computer is a CE device.</p>
Delete after send	<p>Select this check box to delete the file from the TerraSync document folder when you attach it to an e-mail message. If you select this check box, the data file is moved to the e-mail program's outbox. If you clear this check box, a copy of the data file is placed in the outbox, and the original file remains in the document folder.</p> <p>If space on the field computer is limited, select this check box. Only one copy of the file will be stored on the field computer. The stored file cannot be opened in the TerraSync software. When you next connect to the selected e-mail service and send the e-mail, the data file is deleted.</p>

Receive via E-mail form

- **Fields**

NOTE — This option is only available on field computers that have e-mail support.

When you select Receive via E-mail from the options list in the **File Manager screen**, the Receive via E-mail form appears.

Use this form to check your e-mail program's inbox for e-mails that have Trimble data files attached to them, and transfer the attached files to the TerraSync software.

NOTE — You can only use this form to receive files sent by e-mail from:

- the Trimble Data Transfer utility (by transferring the files to a GIS E-mail device)
- the GPS Pathfinder Express service

To receive e-mailed files, enter a subject line in the Subject must contain field, select the Allow file overwrites check box if you want to overwrite existing files with new ones of the same name, and tap **OK**.

The TerraSync software searches the inbox of your e-mail program, selects any e-mails whose subject line includes the text you specified, and transfers any files attached to these e-mails to the TerraSync data folder. The Receive via E-mail form closes.

TIP — In the Trimble Data Transfer utility in the GPS Pathfinder Office software, you can specify a subject line prefix for each e-mail you send. To transfer all data files successfully into the TerraSync software, make sure that the prefix you specify in Data Transfer matches the text you specify in this form.

The screenshot shows a mobile application interface for receiving files via email. At the top, there's a title bar with a 'Data' dropdown menu, a 'Manager' dropdown menu, and system icons for signal strength, battery, and a close button. Below the title bar, there are 'OK' and 'Cancel' buttons. The main content area has a label 'Subject must contain:' followed by a text input field containing 'Trimble File:'. Below that is a label 'Allow file overwrites:' followed by an unchecked checkbox.

If you have set up your e-mail program to leave file attachments on the mail server until requested, the software displays a message asking you to confirm that you want to download each attached file from the server.

NOTE — The TerraSync software can only receive the following file types by e-mail:

- data files
- background files
- configuration files
- waypoint files (when sent as data files)
- data dictionary files

Receive via E-mail form: Fields

Field	Description
Subject must contain	A subject line to search your e-mail inbox for. Only e-mails containing this text in their subject line will be recognized by the TerraSync software as having Trimble data files attached. If you have received files in the TerraSync software before, this field defaults to the last subject line you used.
Allow file overwrites	This field specifies whether to allow received files to overwrite existing files of the same name.
Service	The e-mail service that you want to use to receive the message. This field lists all the services that you have defined in your e-mail program. By default, the ActiveSync service is selected. The ActiveSync service synchronizes the field computer's inbox with the desktop computer's inbox, so that any new e-mails in the desktop computer's inbox are copied to the field computer's inbox. This field only appears if the field computer is a CE device.

New dictionary form

- **Fields**

When you select New dictionary from the options list in the **File Manager screen**, the New dictionary form appears.

Use this form to specify a name for the new data dictionary. When you have entered a name, tap **OK** to open the **Edit dictionary form**. Use that form to add features and attributes to the data dictionary.

New dictionary form: Fields

Field	Description
Create dictionary file	A name for the new data dictionary. A default filename is provided, but you can change or replace this name.



The screenshot shows a mobile application interface for creating a new dictionary. At the top, there is a status bar with icons for 'Data', a signal strength indicator, a battery level indicator, and a close button. Below the status bar is a header bar with the text 'Data Manager' and a dropdown arrow. The main content area is titled 'New dictionary:' and contains a text input field with the text 'Starfish'. To the right of the input field are two buttons: 'OK' and 'Cancel'.

Edit dictionary form

- Fields
- Edit options
- Options

When you select Edit dictionary from the options list in the **File Manager screen**, or tap **OK** in the **New dictionary form**, the Edit dictionary form appears.

NOTE — If the data dictionary you are editing is embedded in a data file, the title of this form is Edit embedded dictionary.

Use this form to add features or attributes to the selected data dictionary, or to edit the existing features and attributes.

NOTE — Changes that you make to a data dictionary file affect all data files that you create subsequently using this data dictionary. However, existing data files are not affected. Changes to the data dictionary that is embedded in a data file affect only that data file.

The data dictionary is displayed in a Windows Explorer-style tree. Tap + beside a feature name to expand the feature, showing all its attributes. Tap – beside a feature to collapse the feature, hiding its attributes. When a feature or attribute is selected, some of its properties are displayed at the bottom of the screen. The properties shown depend on the type of feature or attribute selected.

Use the **Edit options list** to add, edit, move, duplicate, or delete features and attributes. You can also double-tap a feature or attribute to open an editing form, where you can view or edit its properties. Use the **Options list** to edit general properties of the data dictionary.

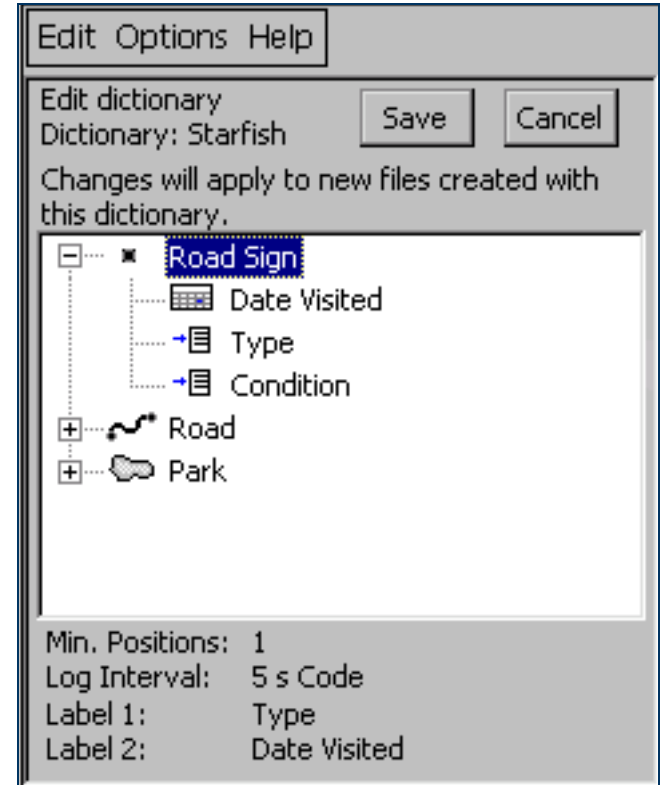

Edit dictionary form: Fields

Field	Description
Filename	The filename of the open file. This field is read-only.
List of features and attributes	The features and attributes in the data dictionary.
Properties	<p>The properties of the selected feature or attribute. The information shown depends on the type of feature or attribute selected.</p> <p>If a feature is selected, the following fields appear:</p> <ul style="list-style-type: none">• Min Positions (for point features), Offset (for line and area features)• Logging Interval• Label 1• Label 2 <p>If an attribute is selected, the following fields appear:</p> <ul style="list-style-type: none">• Attribute type, Default, Format• Max length, Min, Max• Generate, Auto-increment• Creation, Update <p>NOTE — Only the fields that are relevant to the attribute type appear. For example, the Format field appears only for date and time attributes.</p>

Edit dictionary form: Edit options

Option	Description
Edit Feature	Displays the Edit Feature form . Use this form to view or edit the properties of the selected feature.
Edit Attribute	Displays the Edit Attribute form . Use this form to view or edit the properties of the selected attribute.
Delete Feature	Deletes the selected feature. A message appears, asking you to confirm the deletion. Tap Yes to continue.
Delete Attribute	Deletes the selected attribute. A message appears, asking you to confirm deletion. Tap Yes to continue.
New Feature	Opens the Edit Feature form . Use this form to add a new feature to the data dictionary.
New Attribute	Opens the New Attribute Type form . Use this form to specify the type of attribute to add to the selected feature.
Undo	Undoes the last action.
Cut	Copies the selected feature or attribute and deletes it from the data dictionary. Before you paste the copy, select the feature or attribute that you want to paste it after.
Copy	Copies the selected feature or attribute. Before you paste the copy, select the feature or attribute that you want to paste it after.
Paste	Pastes the cut or copied feature or attribute after the selected feature or attribute.
Move Up	Moves the selected feature or attribute one position higher in the list.
Move Down	Moves the selected feature or attribute one position lower in the list.
Expand All Features	Expands all features in the data dictionary, so that all attributes are visible.
Contract All Features	Collapses all features in the data dictionary, so that no attributes are visible.

Edit dictionary form: Options

Option	Description
Settings for All Features	Opens the Settings for All Features form .
Auto-generation of Labels	Automatically sets the two labels for each feature type to the first two attributes of that feature type.
Unique Feature Names	This field specifies whether duplicate feature names are allowed in the data dictionary. If this option is selected, the Data Dictionary editor checks that all feature names are unique when you save the data dictionary.
Numeric Defaults Required	This field specifies whether each numeric attribute in the data dictionary is required to have a default value.

Edit Feature form

When you open a feature for editing, or open a new feature, the Edit Feature form appears. Use this form to specify the feature type (point, line, or area), its default logging settings, and its display settings. The title of the form is New Feature or Edit Feature, depending on whether you are adding a new feature or editing an existing one. The Edit Feature form has four tabs. The tabs that appear depend on the feature type:

Tab	Availability
<ul style="list-style-type: none">• Properties tab	All feature types.
<ul style="list-style-type: none">• Default Settings tab	All feature types.
<ul style="list-style-type: none">• Symbol tab	Point features only.
<ul style="list-style-type: none">• Line Style tab	Line and area features only.

The screenshot shows a dialog box titled "New Feature". The title bar includes a help icon (?), an "OK" button, and a close icon (X). The dialog has three tabs: "Properties", "Default Settings", and "Symbol". The "Properties" tab is selected. Below the tabs, there are two text input fields: "Feature Name:" and "Comment:". Below these is a "Feature Classification" section with three radio buttons: "Point" (which is selected), "Line", and "Area". At the bottom of the dialog are "OK" and "Cancel" buttons.

Properties tab

- **Fields**

Use the Properties tab of the **Edit Feature form** to specify the feature's name and type.

Properties tab, Edit Feature form: Fields

Field	Description
Feature	The name of the feature. You can enter up to 20 characters, including spaces and underscores, but you cannot use punctuation.
Comment	An optional description of the feature, or any other comments. You can enter up to 40 characters, including punctuation.
Feature Classification	The feature type. The options are: <ul style="list-style-type: none">• Point A single geographical location, such as a tree or road sign.• Line A connected series of positions, such as a fenceline, road, or river.• Area A polygon or closed line, such as a lake or park.

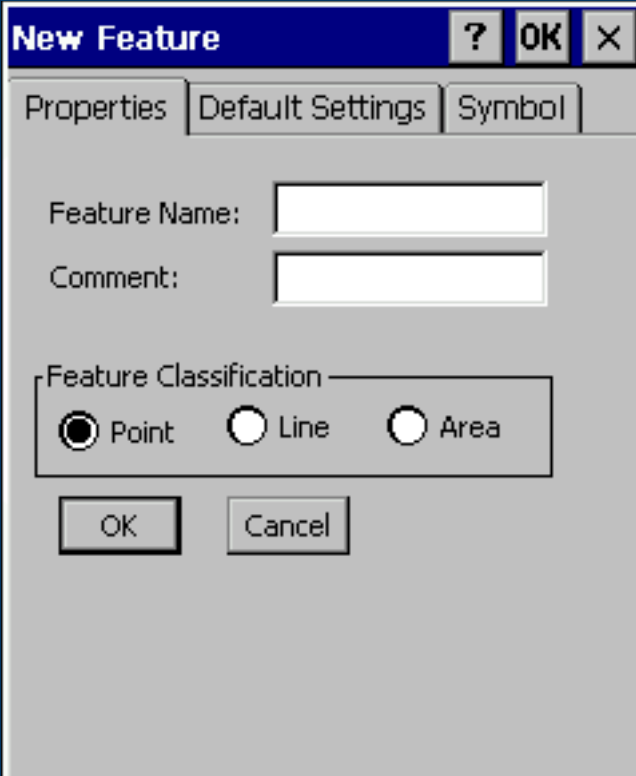

The screenshot shows a dialog box titled "New Feature" with three tabs: "Properties", "Default Settings", and "Symbol". The "Properties" tab is active. It contains the following fields and controls:

- Feature Name:** A text input field.
- Comment:** A text input field.
- Feature Classification:** A group box containing three radio buttons: "Point" (selected), "Line", and "Area".
- Buttons:** "OK" and "Cancel" buttons at the bottom.

Default Settings tab

- Buttons
- Fields

Use the Default Settings tab of the **Edit Feature form** to specify default logging settings. The fields and buttons that appear depend on the feature type (point, line, or area).

Default Settings tab, Edit Feature form: Buttons

Button	Description
Default	Resets the general feature properties to their default settings, as defined in the Settings for All Features form .
Change Format	Switches between displaying offsets in Horizontal/Vertical format and displaying them in Distance/Inclination format.

The screenshot shows the 'New Feature' dialog box with the 'Default Settings' tab selected. The 'Logging Interval' section has three radio buttons: 'Time' (selected), 'Distance', and 'Off'. The 'Time' option has a value of '5' and a unit of 'seconds'. The 'Distance' option has a value of '5' and a unit of 'meters'. The 'Accuracy' section has a dropdown menu set to 'Code'. The 'Offset' section has a 'Direction' dropdown set to 'Left', a 'Horizontal Distance' field with '0.00 m', and a 'Vertical Distance' field with '0.00 m'. A 'Change Format' button is located at the bottom of the dialog.

Default Settings tab, Edit Feature form: Fields

Field	Description	Default
Logging interval	<p>The default logging style. The options are:</p> <ul style="list-style-type: none"> • Time Log a new position when a certain time has elapsed since logging the last position for this feature. • Distance Log a new position when you have moved a certain distance from the last position logged for this feature. • Off Do not log GPS positions for this feature. 	Time
Time	The time between positions and the unit of measure (seconds or minutes), when Time is selected as the logging interval.	5 seconds
Distance	<p>The distance between positions and the unit of measure (meters or feet), when Distance is selected as the logging interval.</p> <p>This field only appears if the feature is a line or area.</p>	5 meters
Minimum Positions	<p>The minimum number of positions to log.</p> <p>This field only appears if the feature is a point feature.</p>	1
Accuracy	This field specifies whether to log the usual code phase data from the GPS receiver, or to log more detailed but more accurate carrier phase data.	Code
Direction	<p>The default direction to the feature, relative to your path of travel. The options are:</p> <ul style="list-style-type: none"> • Left • Right 	Left
Horizontal Distance	<p>The default two-dimensional distance to the feature. The horizontal distance ignores any difference in height between your position and the feature.</p> <p>This field only appears if the offset format is Horizontal/Vertical. Use the Change Format button to switch between the display formats.</p>	0.00 m
Vertical Distance	<p>The default vertical distance between your position and the feature.</p> <p>This field only appears if the offset format is Horizontal/Vertical.</p>	0.00 m

Default Settings tab, Edit Feature form: Fields (Continued)

Field	Description	Default
Slope Distance	The default three-dimensional distance between your position and the feature. This field only appears if the offset format is Distance/Inclination.	0.00 m
Inclination	The default angle of inclination between your position and the feature. This field only appears if the offset format is Distance/Inclination.	0.00°
Label 1	The attribute that will be used as the first label for the feature. Labels appear in the Update Features screen and in the position information in the Map section .	First attribute
Label 2	The attribute that will be used as the second label for the feature.	Second attribute

Symbol tab

- Buttons
- Fields

Use the Symbol tab of the Edit Feature form to specify the appearance of the symbol that is used to represent this feature in the Map section and Update Features list. This tab only appears if the selected feature is a point feature.

TIP — In the **Map section**, you can choose to display the color you select in this tab, or the color of the map layer that the feature belongs to.

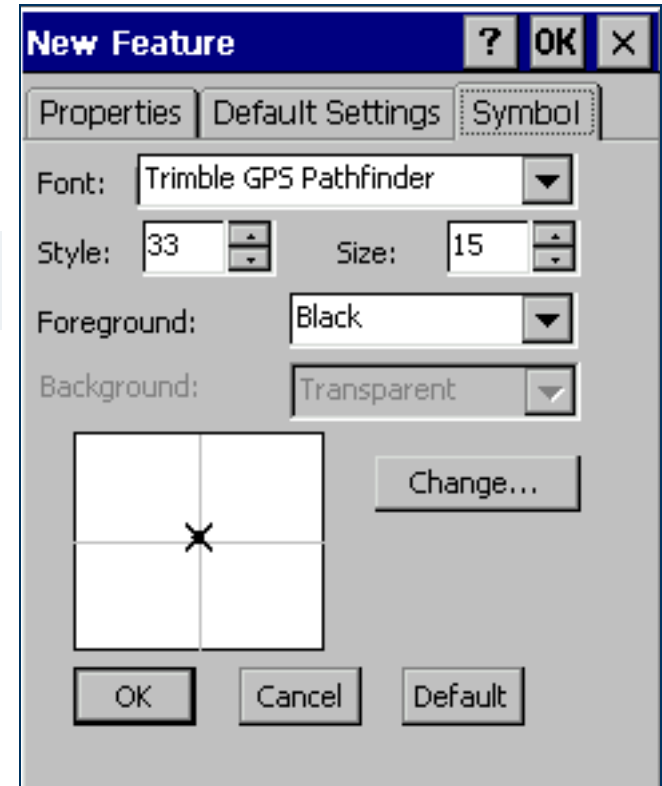

Symbol tab, Edit Feature form: Buttons

Button	Description
Default	Resets the symbol properties to the defaults. The default point symbol is ✕ (symbol style 33 from the Trimble GPS Pathfinder font, black, 15 points).
Change	Selects a different font or symbol style.

Symbol tab, Edit Feature form: Fields

Field	Description	Default
Font	The font to use for the point feature symbol. You can use any font that is installed on the field computer.	Trimble GPS Pathfinder
Style	The symbol from the font that you want to use. Symbols are identified by their ASCII character codes, and a preview of the selected symbol is displayed.	33
Size	The size that the symbol is displayed at.	15
Foreground	The color of the point symbol.	Black
Background	The background color of the point symbol. When TerraSync is installed on a CE device, this field is read-only.	Transparent

Line Style tab

- Buttons
- Fields

Use the Line Style tab of the Edit Feature form to specify the appearance of the line used to represent this feature in the Map section and Update Features list. This tab only appears if the selected feature is a line or area feature.

TIP — In the **Map section**, you can choose to display the color you select in this tab, or the color of the map layer that the feature belongs to.

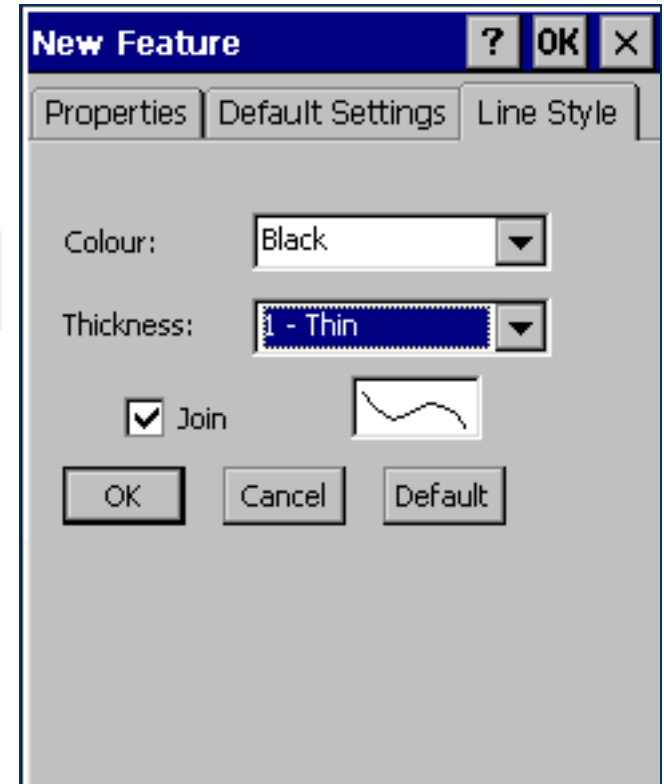

Line Style tab, Edit Feature form: Buttons

Button	Description
Default	Resets the line style properties to their default settings (thin black joined line).

Line Style tab, Edit Feature form: Fields

Field	Description
Color	The color of the feature.
Thickness	<p>The thickness of the line, or, if the line is not joined, the diameter of the circles that represent the positions in the line. The options range from a thin line (1 pixel wide) to a thick line (6 pixels wide).</p> <p>TIP — Thicker lines take longer for the software to draw. Use thin lines when you want to maximize the Map screen's drawing speed.</p>
Join	<p>This field specifies whether to display only the positions in the line or area (as circles in the selected color and thickness), or to join all the positions into a line.</p> <p>NOTE — In TerraSync, positions are always joined. However, when the line or area feature is viewed in GPS Pathfinder Office, this setting is used to determine its appearance.</p>

New Attribute Type form

- **Attribute types**

Use this form to select the type of attribute that you want to add to the selected feature. Select the attribute type from the list of options. Then tap **Add** to open the **Edit Attribute form**, where you can give the attribute a name and set its properties.

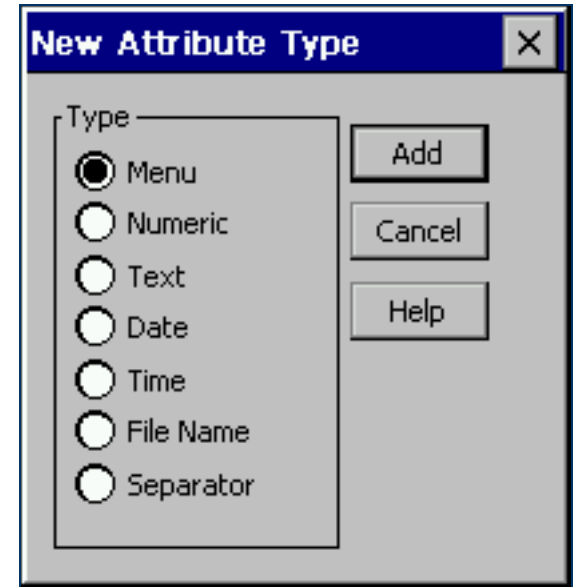

New Attribute Type form: Attribute types

Attribute type	Description
Menu	The value to be stored in the attribute can be selected from a predefined list. For example, the possible values for an attribute called Surface Type for the Road feature may be Asphalt, Concrete, Gravel, and Dirt. The range of possible values is stored in the data dictionary. In the field, you choose the correct value from the list.
Numeric	A set of decimal or whole numbers. For example, these values could represent the girth or height of a tree or the concentration of a pollutant at a particular location.
Text	The value to be stored in the attribute is a string of characters, such as the name of a street.
Date	The value to be stored in the attribute is a date, such as the date of installation of a power pole or the date you collected a feature.
Time	The value to be stored in the attribute is a time value, such as the time you read a meter or the time you collected a feature.
File Name	The value to be stored in the attribute is the name of a file on the field computer. For example, you can use a filename attribute to associate a digital picture of the feature with the feature being collected.
Separator	A separator attribute cannot be edited and does not store a value. It is used to group related attributes or to provide a break in a long list of attributes.

Edit Attribute form

- **Buttons (for menu attributes only)**
- **Fields**

When you select Edit Attribute from the **Options list**, or tap **Add** in the **New Attribute Type form**, the Edit Attribute form appears.

Use this form to add a new attribute to the selected feature, or to edit an existing attribute.

The form's title depends on the attribute type, and whether that you are adding or editing the attribute. For example, if you are editing a date attribute, the title is Edit Date Attribute. If you are adding a menu attribute, the title is New Menu Attribute. The buttons and fields that appear depend on the attribute type.

Edit Attribute form: Buttons (for menu attributes only)

Button	Description
New	Opens the Edit Attribute Value form . Use this form to add new attribute values.
Edit	Opens the Edit Attribute Value form . Use this form to edit the selected attribute value.
Delete	Deletes the selected attribute value.
Up arrow	Moves the selected attribute value to the previous position in the list.
Down arrow	Moves the selected attribute value to the next position in the list.

The screenshot shows the 'Edit Date Attribute' form. The title bar is blue with the text 'Edit Date Attribute' and a close button. The form has a light gray background. At the top, there is a text field for 'Attribute Name' containing 'Date Visited' and a 'Comment' field. Below these are two checkboxes: 'Auto Generate on Creation' (checked) and 'Auto Generate on Update' (unchecked). A 'Format' section contains three radio buttons: 'Day - Month - Year', 'Month - Day - Year', and 'Year - Month - Day' (selected). The 'Field Entry' section is divided into two columns: 'On Creation' and 'On Update'. Each column has two radio buttons: 'Normal' (selected) and 'Required' (unchecked).

Edit Attribute form: Fields

Field	Description	Default
Attribute Name	The name of the attribute. You can enter up to 20 characters, including spaces and underscores, but you cannot use punctuation.	(none)
Comment	An optional description of the attribute, or any other comments. You can enter up to 40 characters, including punctuation.	(none)
On Creation	Editing rules for the attribute when a new feature is opened. The options are: <ul style="list-style-type: none">• Normal Entering a value for this attribute is optional.• Required A value must be entered for this attribute.• Not Permitted The value of this attribute cannot be changed.	Normal
On Update	Editing rules for the attribute when the feature is opened for update. The options are the same as for the On Creation field.	Normal
Menu Attribute Values	The list of values for a menu attribute. Use the New and Edit buttons to add or edit values in this list. This field only appears if the attribute type is Menu.	(none)
Decimal Places	The number of decimal places for a numeric attribute. This field only appears if the attribute type is Numeric.	0
Minimum	A minimum value for a numeric attribute. This field only appears if the attribute type is Numeric.	0
Maximum	A maximum value for a numeric attribute. This field only appears if the attribute type is Numeric.	0

Edit Attribute form: Fields (Continued)

Field	Description	Default
Auto-Incrementing	<p>This field specifies whether the default value for the attribute is supplied by automatically incrementing (or decrementing) the value of the last attribute of this type that was entered. The options are:</p> <ul style="list-style-type: none">• No Increment No auto-incremented default value is supplied.• Increment An auto-incremented default value is supplied. <p>This field only appears if the attribute type is Numeric or Text.</p>	No Increment
Step Value	<p>The amount by which the attribute value increments or decrements. This field only appears if the attribute type is Numeric or Text.</p>	+1
Length	<p>The maximum length for a text attribute. The length can be any integer from 1 to 100. This field only appears if the attribute type is Text.</p>	30
Default	<p>A default value for the attribute.</p>	(none)

Edit Attribute form: Fields (Continued)

Field	Description	Default
Auto Generate on Creation	This field specifies whether the attribute is automatically filled in with the current date or time when the feature is created. This field only appears if the attribute type is Date or Time.	Selected
Auto Generate on Update	This field specifies whether the attribute is automatically filled in with the current date or time when the feature is opened for update. This field only appears if the attribute type is Date or Time.	Not selected
Format	The display format of the attribute. If the attribute type is Date, the options are: <ul style="list-style-type: none">• Day - Month - Year• Month - Day - Year• Year - Month - Day If the attribute type is Time, the options are: <ul style="list-style-type: none">• 24 Hour• 12 Hour This field only appears if the attribute type is Date or Time.	Year - Month - Day (for Date attributes) <i>or</i> 24 Hour (for Time attributes)

Edit Attribute Value form

- Buttons
- Fields

When you tap New or Edit in the **Edit Attribute form**, the Edit Attribute Value form appears.

Use this form to add new attribute values, or edit existing values, for the selected menu attribute. The title of the form is New Attribute Value or Edit Attribute Value, depending on whether you are adding a new attribute value or editing an existing one.

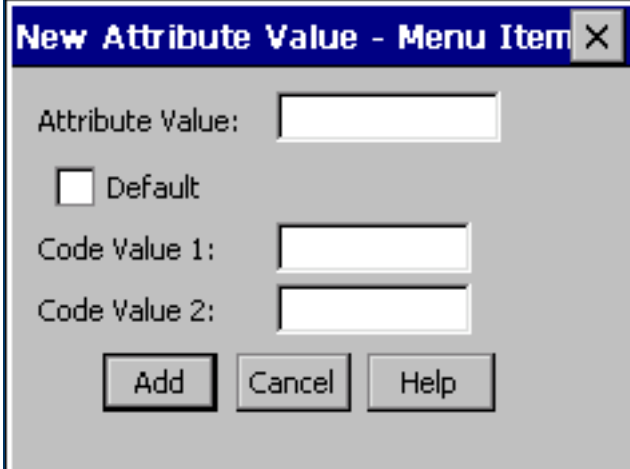

The screenshot shows a dialog box titled "New Attribute Value - Menu Item" with a close button (X) in the top right corner. The dialog contains the following elements:

- An "Attribute Value:" label followed by a text input field.
- A checkbox labeled "Default" positioned to the left of the "Attribute Value" input field.
- A "Code Value 1:" label followed by a text input field.
- A "Code Value 2:" label followed by a text input field.
- Three buttons at the bottom: "Add", "Cancel", and "Help".

Edit Attribute Value form: Buttons

Button	Description
Add/OK	<p>Adds the new value to the list, or confirms the changes that you have made to the existing value. If you opened this form by tapping Add in the Edit Attribute form, this button is labeled Add. When you tap it, the form remains open so that you can add a number of values to the list without reopening this form each time.</p> <p>If you opened this form by tapping Edit in the Edit Attribute form, this button is labeled OK. When you tap it, the form closes.</p>
Cancel/Close	<p>Closes this form.</p> <p>If you have made changes in this form but have not yet tapped Add or OK, this button is labeled Cancel. If you use it to close the form, a message appears asking you to confirm that you want to close the form without saving any changes. Tap Yes to continue.</p> <p>If you have saved changes by tapping Add, this button is labeled Close.</p>

Edit Attribute Value form: Fields

Field	Description
Attribute Value	The value of the attribute. The value can be up to 20 characters long.
Default	This field specifies whether this value is the default value in the list.
Code Value 1	<p>A code value for this attribute value. Use code values if you want to see a list of descriptive attribute values in the field, but you need to export a code to the GIS or CAD system.</p> <p>Code values are optional, and can be up to 6 characters long.</p>
Code Value 2	A second code value for this attribute value.

Settings for All Features form

- Buttons
- Fields

Use this form to specify default logging settings for all features in the data dictionary. When you create a new feature, or tap **Default** in the Edit Feature form's **Default Settings tab**, the feature's logging settings are set to the values that you define in this form.

When the selected feature is a point, the fields on the Point tab are the same as the fields on the **Default Settings tab** of the Edit Feature form.

When the selected feature is a line or area, the fields on the Line and Area tabs are the same as those on the **Default Settings tab**.

CAUTION — Changes that you make in this form overwrite any customized feature defaults in the data dictionary.

The screenshot shows the 'Settings for All Features' dialog box. The title bar includes a help icon (?), an 'OK' button, and a close button (X). The dialog has three tabs: 'Point', 'Line', and 'Area'. The 'Point' tab is active. The 'Logging Interval' section has two radio buttons: 'Time' (unselected) and 'Off' (selected). The 'Time' radio button is followed by a text box containing the number '5' and a '(Seconds)' label. Below this is a 'Minimum Positions' label followed by a text box containing the number '1'. Below that is an 'Accuracy:' label followed by a dropdown menu showing 'Code'. At the bottom of the dialog are three buttons: 'OK', 'Cancel', and 'Default'.

Read dictionary from data form

- **Fields**

When you select the Read dictionary from data option from the options list in the **File Manager screen**, the Read dictionary from data form appears.

Use this form to extract the data dictionary from a TerraSync data file. Before you open the form, first make sure that the data file selected in the File Manager screen is the one that you want to extract the dictionary from.

In the Read dictionary from data form, specify an output filename in the Create dictionary file field. To create the file, tap **OK**. When the file has been created, the form closes and you are returned to the **File Manager screen**. The new file appears in the **List of files** when Dictionaries is selected in the **Choose File Type** field.



The screenshot shows a mobile application dialog box titled "Data" with a "Manager" dropdown menu. The dialog contains two buttons, "OK" and "Cancel". Below the buttons is a section labeled "Create dictionary file:" with a text input field containing the text "Starfish". At the bottom of the dialog, there is a label "Data File:" followed by the text "Starfish".

Read dictionary from data form: Fields

Field	Description
Create dictionary file	The name of the new data dictionary file. TerraSync uses the name of the data file as the default filename for the new data dictionary. You can edit this default name, or enter an entirely different name. Filenames must follow the naming rules for Windows.
Data File	The selected data file. Use this field to check that the correct data file is selected. This field is read-only. To change the selected data file, tap Cancel and select a different file in the File Manager screen .

Read from Shape form

- **Fields**

When you select the Read data from Shape option from the options list in the **File Manager screen**, the Read from Shape form appears.

Use this form to convert ESRI Shapefiles on the field computer into data, data dictionary, or **vector** background files suitable for use in the TerraSync software. You can select which input files to use, and the name of the output file, but you cannot change any other conversion settings.

Before you open the Read from Shape form, make sure that the file type selected in the Choose File field on the File Manager screen is the file type that you want to create. For example, if you want to create a data dictionary from Shapefiles, select Dictionaries in the Choose File field. Then tap **Options** and select Read data from Shape.

Also make sure that the coordinate system that you want the output file to use is selected in the Setup section. For more information, see **Coordinate System**.

In the Read from Shape form, specify an output filename in the Create <file type> file field, and check that the coordinate system shown is correct. Then select the folder on the field computer that contains the Shapefiles you want to convert. To select the folder, enter its full path and name in the From Shape file(s) in field. Alternatively, tap the drop-down arrow and, in the pop-up window that appears, navigate to the required folder.

The screenshot shows the 'Read from Shape' dialog box. At the top, there is a title bar with a 'Data' dropdown menu, a 'Manager' dropdown menu, and 'OK' and 'Cancel' buttons. Below the title bar, the text 'Read from Shape' is displayed. The main area contains the following fields and options:

- Create data file:** A text input field containing 'R061720C'.
- From Shape files(s) in:** A dropdown menu showing '\My Documents'.
- Coordinate system:** A text field containing 'Latitude/Longitude'.
- Datum:** A text field containing 'WGS 1984'.
- Include:** A section with a checkbox labeled 'Park' which is currently unchecked.

Once you have selected an input folder, a separator field called Include appears, followed by a check box for each Shapefile in the folder. To include a Shapefile in the conversion, select its check box. To exclude a file, clear its check box.

To begin the conversion, tap **OK**. The fields on the form are replaced by a progress bar and summary information about the conversion.

When the files have been converted, the message **Shape conversion complete** replaces the progress bar. The same message also appears in a tooltip in the status bar.

Tap **Close** to return to the **File Manager screen**. The new file appears in the **List of files**.

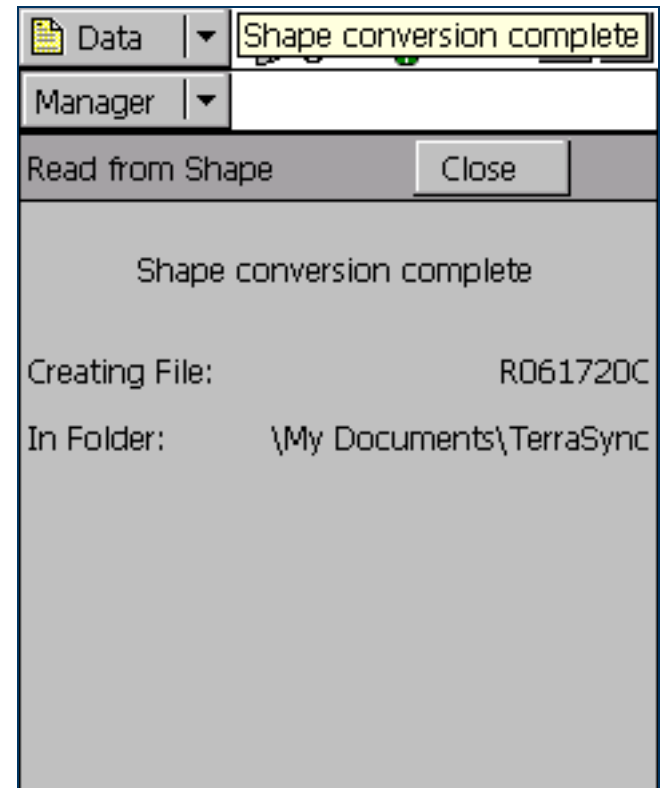

Read from Shape form: Fields

Field	Description
Create <file type> file	<p>The name of the new file. The TerraSync software automatically generates a default filename for the new data, data dictionary, or background file, using the same naming convention as in the File Name field in the New File subsection.</p> <p>You can edit this default name, or enter an entirely different name. Filenames must follow the naming rules for Windows, but you should not specify an extension.</p>
From Shape file(s) in	<p>The folder where the source Shapefiles are stored.</p>
In coordinate system	<p>The current coordinate system. Use this field to check that the coordinate system to be used by the new file is correct.</p> <p>NOTE — When you create a data or background file, the current coordinate system <i>must</i> match the coordinate system in the input Shapefiles. Use the Setup section's Coordinate System form to change the coordinate system if necessary. When you create a data dictionary file, the coordinate system does not matter.</p>
Include	<p>A list of the Shapefiles in the selected folder. To include features in a Shapefile in the converted file, select the check box beside the Shapefile's name.</p>

Write to Shape form

- **Fields**

When you select the Write data to Shape option from the options list in the **File Manager screen**, the Write to Shape form appears.

Use this form to convert a data file from the TerraSync software into ESRI Shapefiles. You can select the location of the output files, but you cannot change any other conversion settings. The conversion creates a separate Shapefile for each feature type in the input data file.

The input data file in the **Convert file** field is the file that was highlighted in the list of files in the **File Manager screen**. To change the selected file, return to the File Manager screen and select a different file.

To convert a data file to Shapefiles, select the folder on the field computer where you want to create the Shapefiles. To select the folder, enter its full path and name in the Write Shape file(s) to field.

Alternatively, tap the drop-down arrow and, in the pop-up window that appears, navigate to the required folder.

To begin the conversion, tap **OK**. The fields on the form are replaced by a progress bar and summary information about the conversion.

When the file has been converted, the message **Shape conversion complete** replaces the progress bar. Tap **Close** to return to the **File Manager screen**.

The screenshot shows the 'Write to Shape' dialog box. At the top, there is a title bar with a 'Data' menu, a 'Manager' menu, and icons for help and close. Below the title bar are 'OK' and 'Cancel' buttons. The main area of the dialog contains the following fields:

- Convert file:** Starfish
- Write Shape file(s) to:** \My Documents (with a dropdown arrow)
- Coordinate system:** Latitude/Longitude
- Datum:** WGS 1984

Write to Shape form: Fields

Field	Description
Convert file	The name of the file to be converted. Use this field to check that you have selected the correct input data file. If this field does not show the correct filename, return to the File Manager screen, highlight the correct file in the list, and select the Write data to Shape option again.
Write Shape file(s) to	The folder where the Shapefile(s) will be stored.
Coordinate system	This field shows the current coordinate system, which is the coordinate system that will be used for the new data file. Use the Setup section's Coordinate System form to change the coordinate system if necessary.
Zone	The currently selected coordinate system zone. This field does not appear if the selected coordinate system has no zones.
Datum	The datum that the selected coordinate system and zone are associated with. If the system can be associated with only one datum, this field does not appear.

Navigation section

Use the Navigation section to:

- make sure that you follow a direct course to a target location
- revisit features that you have previously mapped

Even if you do not want to navigate to a particular point, you can use the Navigation section to view information such as your current heading or the distance from your current position to the target.

There are two navigation modes, depending on how close you are to the navigation target. Use the **Direction Dial** to navigate to the target from a distance. Use the **Close-up screen** to navigate to the exact location of the target. In either mode, you can use the **Lightbar** at the top of the screen to guide you to the target.

NOTE — With **real-time differential GPS**, you can navigate to an accuracy of one meter or less, depending on factors such as the GPS receiver and the frequency at which corrections are received. Without any form of real-time differential corrections, you are subject to errors introduced by GPS and atmospheric conditions. These errors degrade the accuracy of navigation. Autonomous navigation (without real-time corrections) can be useful to get you close to the feature, but it may be less useful for locating a specific feature if similar features are near to each other, or if the feature is underground.

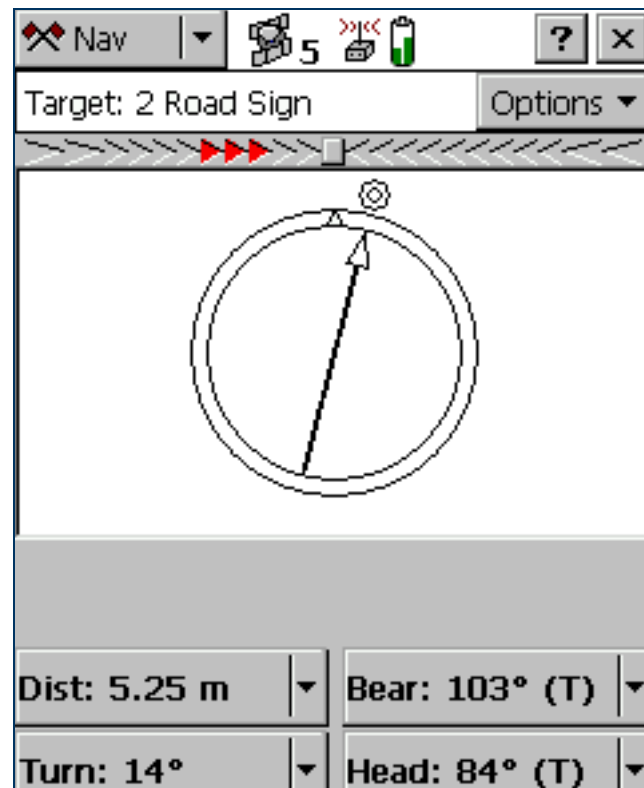

Direction Dial

- **Fields and icons**

When you first open the Navigation section, the default screen displayed is the Direction Dial graphical screen.

The Direction Dial graphical screen provides a simple dial which shows you all the information you need to get to the target. It is very useful for navigation in open country or where you can follow a direct route to the target.

- **Using the Direction Dial**

TIP – You cannot set the navigation target in the Navigation section. Select a target from the **Data section** or the **Map section**.

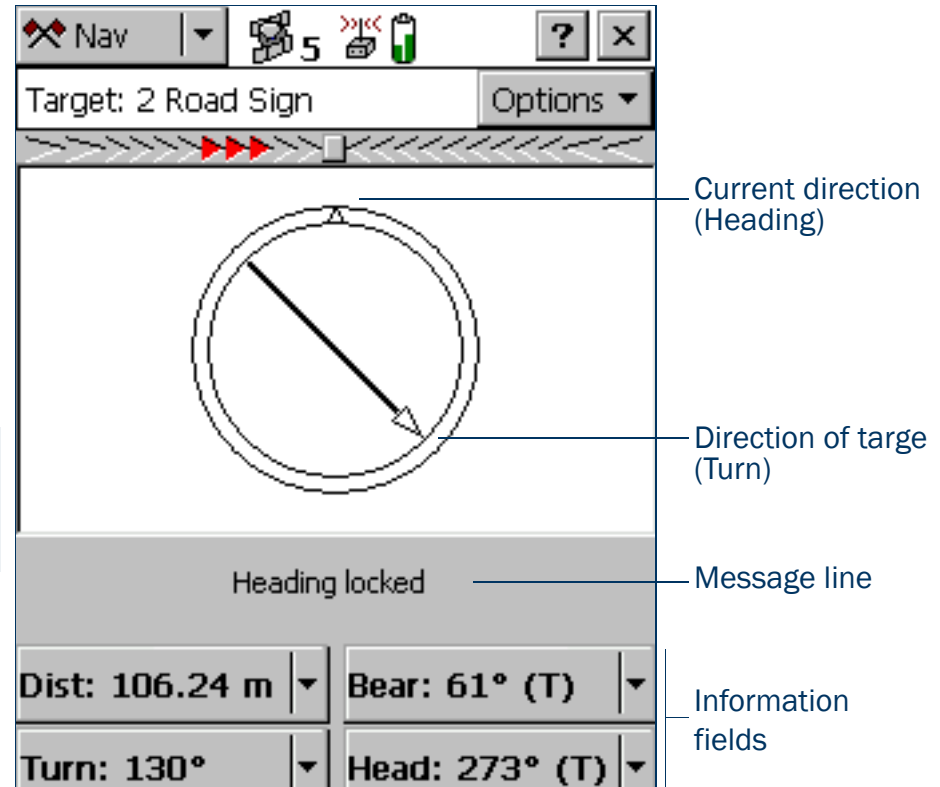

Direction Dial: Fields and icons

Item	Description
Target	<p>This field indicates the current navigation target:</p> <ul style="list-style-type: none">• If a feature is selected, the feature ID and feature type appear.• If you have selected a map point, the text Map Point appears.• If you have constructed a target by specifying an offset from the navigation start, the text Constructed appears.• If no target is selected, the text No Target appears.
Nav Start	<p>If you have specified a navigation start and target, but the start is further away from your position than the configured Range, you must navigate to the start before you can navigate to the target. While you are navigating to the start, the Nav Start field appears instead of the Target field. Once you have navigated within close-up range of the start, the Nav Start field is replaced by the Target field and you can start navigating to the target.</p> <p>Like the Target field, the Nav Start field identifies the navigation start:</p> <ul style="list-style-type: none">• If a feature is selected, the feature ID and feature type appear.• If you have selected a map point, the text Map Point appears.
Lightbar	The Lightbar guides you along the shortest path between the navigation start and the target.
Heading	The top of the dial indicates your direction of travel (heading).
Turn arrow	The turn arrow shows the direction you should travel in order to take the shortest path between the current GPS position and the target.
Message line	The Message line displays messages relating to navigation.
Information fields	The Information fields at the bottom of the screen provide navigational information.

Using the Direction Dial

To activate navigation, use the **Data section** or the **Map section** to select a navigation *target*. When you select a target, the Direction Dial displays information that helps you to navigate to the target. The Direction Dial graphically displays your heading and the bearing to the target. The **Information fields** at the bottom of the screen display relevant text information. The message line also shows relevant information for navigation.

The heading along which you are moving (your current direction of travel) is always shown at the top of the dial. The Turn arrow shows where the target is, relative to your heading. To navigate to the target, simply line up the arrow (the direction of the target) with the triangle at the top of the dial (your current direction of travel).

The arrow on the dial rotates according to your direction of travel. Consequently, the dial only provides an accurate reading when you are moving, and a direction of travel can be determined by the receiver. If you are moving too slowly, or are standing still, the Heading arrow freezes. For more information, see **Message line**.

TIP — Because the Direction Dial screen is based on your heading, it works best if you do not move backwards.

NOTE — Until GPS is acquired and a target is specified, the heading cannot be calculated so the turn arrow does not appear.

If you also select a navigation *start*, you can use the **Lightbar** to navigate along the shortest path from the start to the target. This path is called the **cross-track line**. If you are not within the configured **Range** of the navigation start, you must first navigate to the start before you can navigate to the target.

TIP — You cannot set the navigation start or target in the Navigation section. Select a start and target from the **Data section** or the **Map section**.

NOTE — If you log a new GPS position for the feature that is currently selected as the navigation target, you must reselect the feature as the navigation target before you can navigate to the feature's new location.

Close-up screen

- **Fields and icons**

When you come within the specified **Close-up Range** of the target, the navigation proximity alarm sounds, and the Close-up graphical screen replaces the Direction Dial screen.

- **Using the Close-up screen**

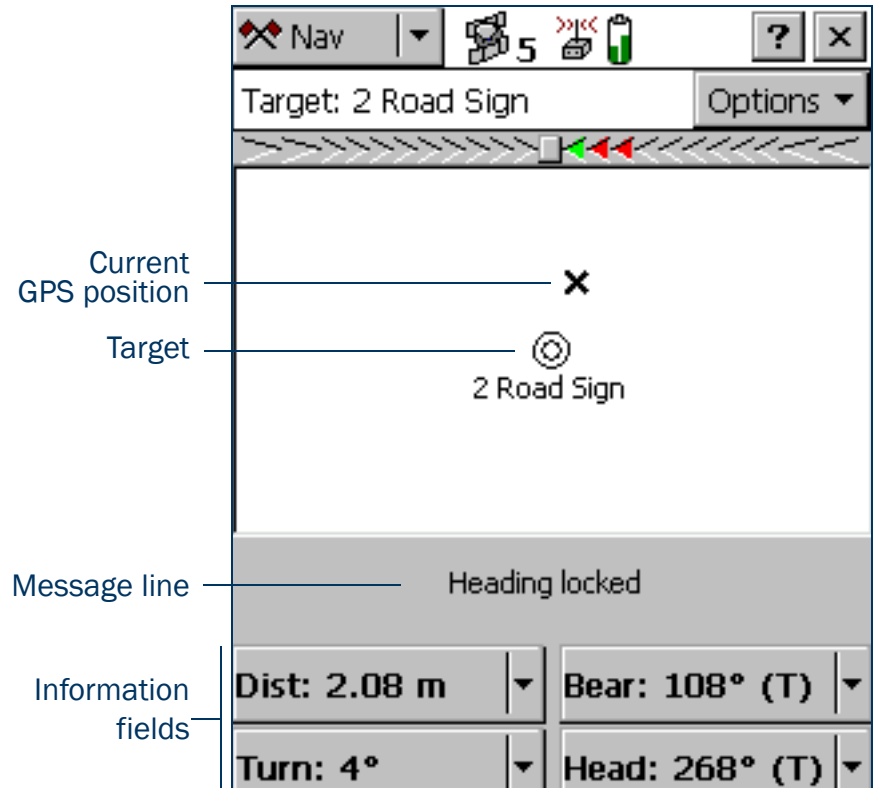

Close-up screen: Fields and icons

Item	Description
Target	<p>This field identifies the current navigation target:</p> <ul style="list-style-type: none">• If a feature is selected, the feature ID and feature type appear.• If you have selected a map point, the text Map Point appears.• If you have constructed a target by specifying an offset from the navigation start, the text Constructed appears.• If no target is selected, the text No Target appears.
Lightbar	The Lightbar guides you along the shortest path between the navigation start and the target.
Bull's-eye	The bull's-eye represents the navigation target.
Cross	The cross represents the current GPS position.
Message line	The Message line displays messages relating to navigation.
Information fields	The Information fields at the bottom of the screen provide navigational information.

Using the Close-up screen

For precision navigation right up to the target, move so that the GPS position cross is in the center of the bull's-eye. Depending on the **Close-up Style** you select, either the bull's-eye or the cross remains fixed in the center of the screen, while the other icon moves around it.

The top of the Close-up screen is relative to the direction that you were traveling in (your heading) when you entered the Close-up screen. The heading is not updated on the Close-up screen, so the screen does not move if you change the direction you are facing while using it.

All **Information fields** that depend on the heading are automatically locked as well. For more information, see **Heading locked**.

TIP — Because the Close-up screen does not update your heading, it works best if you maintain your original direction of travel. If necessary, move sideways or backwards rather than turning.

TIP — To quickly open the feature that is set as the target for update, double-tap the bull's-eye in the Close-up screen.

- **Close-up Range**
- **Close-up Style**

Close-up Range

The close-up range value controls the distance from the target at which the Direction Dial graphical screen switches to the Close-up graphical screen. You can configure the close-up range value either to control the distance at which the Close-up screen appears, or to disable it.

The close-up range also determines the scale that is represented on the Close-up screen. The distance from the edge of the screen to the center represents the close-up range distance.

TIP — If you are zoomed in to a scale that is too close for the GPS accuracy you currently have, the GPS cross appears to leap around the screen. To minimize this effect, select a larger close-up range.

You can configure the close-up range values from the [Navigation options form](#).

Close-up Style

The close-up style can be set to either target-centered or GPS-centered. It controls which position is the fixed reference point in the center of the Close-up screen: your position or the position of the target.

- For the target-centered style, the bull's-eye, representing the target, is fixed in the center of the screen and the GPS cross moves around it as your position changes.
- For the GPS-centered style, the GPS cross, representing your position, is fixed in the center of the screen and the bull's-eye moves around it.

Configure the close-up style in the [Navigation options form](#).

Lightbar

The navigation lightbar appears at the top of the Direction Dial and Close-up screens, as well as in the [Map section](#). It uses colored icons to simulate the colored LEDs of a physical lightbar.

TIP — The lightbar can also be displayed at the top of the Map screen. To do this, select the Cross-Track Light Bar option from the Map section’s [Options list](#).

The lightbar guides you towards the navigation target by graphically representing the **cross-track error**. This is the amount and direction by which your **heading** differs from the **cross-track line**. The cross-track line is the shortest path between the navigation start and target.

NOTE — The lightbar is only available if you have set *both* a navigation start and a navigation target. You can set the start and target in the [Data section](#) or in the [Map section](#).

When the three center icons in the lightbar are green and all the other icons are gray, you are traveling along the cross-track line. When other icons are “lit” in green or red, you are off track. To get back on track, turn in the direction of the lit arrow icons. Continue to adjust your heading until the three center icons are green.

The lightbar’s appearance and behavior depend on the lightbar mode that you have selected: Center or Chase.

In **Center** mode, the center of the lightbar represents the cross-track  line, and the lit icons represent your heading. To stay on track you must “pull” the lit icons towards the center of the lightbar. The arrow icons point towards the cross-track line. If you are off track, turn in the direction that the lit arrow icons are pointing. For example, if arrow icons on the left side of the lightbar are lit, your heading is to the left of the cross-track line, so you must turn to the right to correct your heading.

In **Chase** mode, the center of the lightbar represents your heading, and  the lit icons represent the direction of the cross-track line. To stay on track you must “chase” the lit icons. The arrow icons point towards the cross-track line. If you are off track, turn in the direction that the lit arrow icons are pointing. For example, if arrow icons on the left side of the lightbar are lit, the cross-track line is to the left of your heading, so you must turn to the left to correct your heading.

The lightbar display consists of a square icon in the center, with nine inner arrows and two larger outer arrows on each side. Each inner arrow represents a small cross-track error. The size of the error that each arrow represents is determined by the setting that you specify for the **Inner Lightbar Spacing**. Each outer arrow represents a large cross-track error. The size of the error that each arrow represents is determined by the **Outer Lightbar Spacing**. The total cross-track error is the sum of the errors of each arrow from the center to the middle arrow that is lit.

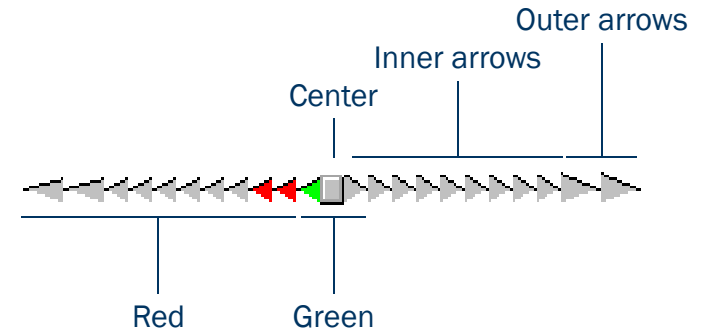

When you are on track, the square center icon is green. When you are off track, three adjacent arrow icons are “lit”. The size of the cross-track error is indicated by the color and location of the lit icons.

If the **square center** icon, and the two arrow icons on each side of it, are green, then you are on track. You do not need to adjust your heading.



If **inner** arrow icons are lit, then you are off track. If a green arrow icon is lit, then you are only slightly off track. If all of the lit icons are red, a larger heading adjustment is required. The farther the lit icons are from the center, the larger the adjustment. For example, if the inner lightbar spacing is 0.5 m, and the middle lit arrow is six from the center, then you are 3 m (6×0.5 m) off track.



If **outer** arrow icons are lit, you are significantly off track. A large heading adjustment is required. For example, if the outer lightbar spacing is 5 m, the inner spacing is 0.5 m, and the middle lit arrow is the first outer arrow, then the cross-track error is 9.5 m. This distance is the sum of the inner arrow error (4.5 m = 9×0.5 m) and the outer arrow error (5 m = 1×5 m)).



Information fields

Additional information about the selected navigation target appears in the configurable information fields. These fields appear on four buttons on **Direction Dial** graphical screen and on the **Close-up screen**.

NOTE — If the field computer uses the landscape orientation, the buttons appear to the right of the Navigation screen.

By default, the four buttons show the **Distance**, **Bearing**, **Turn**, and **Heading** information fields. You can choose four information fields out a total of twelve to display on the buttons.

To change the information field that is displayed on a button, tap the drop-down arrow on the right side of the button, and select the information field from the list that appears. The button displays the label and data for the selected field. If the selected field is already selected on another button, the two fields swap position.

TIP — You can use the **Units form** in the Setup section to change the distance units, velocity units, north reference, and altitude reference.

NOTE — Most information fields are only relevant if a target is selected. Only the **Velocity**, **Heading** and **Altitude** fields show data when no target is selected. If no target is selected, all other fields show the value N/A, and the **Message line** prompts you to select a target. If you are stationary or are not moving fast enough for the software to calculate a heading, these fields show the value ?, and the message line prompts you to start moving.

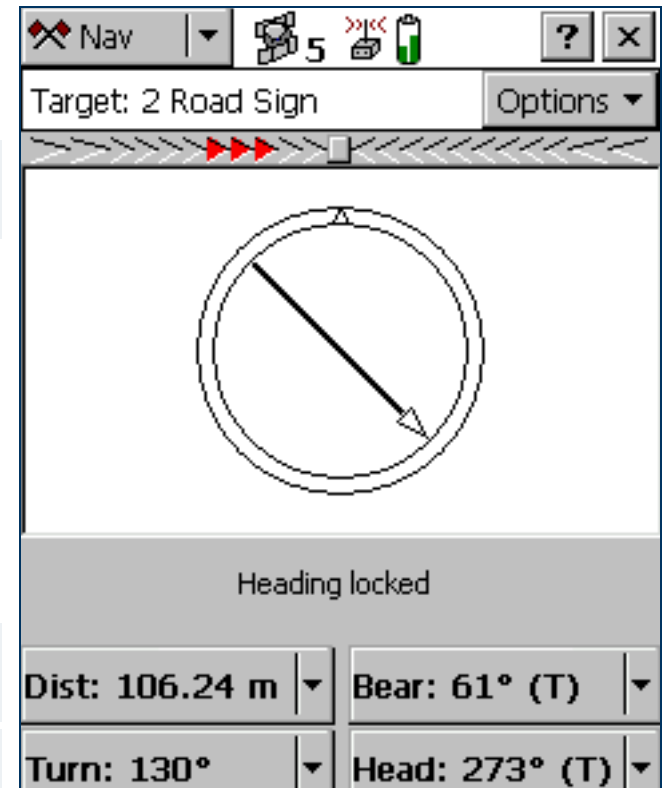

Navigation section: Information fields

Field	Label	Description
Distance	Dist.	The distance to the navigation target. This is the shortest great-circle distance to the target, computed on the local datum .
Bearing	Bear.	The compass bearing (angle) that you should follow in order to take the shortest path between the current GPS position and the target. The bearing is useful if you are navigating in open country and can travel in a direct line to the target. The bearing is displayed with a T if it is relative to true north or an M if it is relative to magnetic north .
Turn	Turn	The direction that you need to turn in, to head towards the target. It indicates the magnitude by which your course should vary. This is the difference between the bearing to the target and the current heading.
Heading	Head	Your current direction of travel. The heading is the angle between the last two GPS positions computed. If you are stationary, or moving very slowly, the heading is locked until you start moving again. The units of this field also include a T or M to indicate whether the heading is relative to true north or magnetic north . The heading is displayed whether or not you have chosen a target.
Cross-track	X-Tk	The direction and distance to the cross-track line. The direction of the cross-track line (left or right) is indicated by (L) or (R) . The numeric value indicates the distance that you must travel in that direction to get back on track. The cross-track error is only displayed if you have selected a start and a target.
Time to Go	TTG	The expected time to reach the target. The time to go takes your current heading and velocity into account. It shows a larger value if you are not heading directly toward the target.
ETA	ETA	The Estimated Time of Arrival (ETA) at the target, based on your current heading and velocity. It shows a larger value if you are not heading directly toward the target. If the arrival time is more than 24 hours in the future, this field displays >24 hr .

Navigation section: Information fields (Continued)

Field	Label	Description
Velocity	Vel.	Your two-dimensional velocity. The velocity is displayed whether or not you have chosen a target.
Altitude	Alt.	The current altitude. This field also shows the configured altitude reference (HAE or MSL). The altitude is displayed whether or not you have chosen a target.
Go Up/Go Down	Up/Down	<p>The difference in altitude between your current altitude and the altitude of the target. This field is useful for 3D navigation. It tells you how far up or down you need to go to be at the same altitude as the target.</p> <p>NOTE — This value is calculated using the altitude of the GPS antenna. If you have specified an antenna height, it is not subtracted from the antenna's altitude before calculating the Go Up/Go Down value.</p>
Go North	Go N	The northerly distance component of the bearing to the target. This field shows the north/south distance from the current GPS position to the target. The Go North and Go East information fields are useful for navigation around city blocks, or when you cannot travel in a direct line to the target.
Go East	Go E	The easterly distance component of the bearing to the target. This field shows the east/west distance from the current GPS position to the target. The Go North and Go East information fields are useful for navigation around city blocks, or when you cannot travel in a direct line to the target.

Message line

The message line appears above the **Information fields**. It displays important messages relevant to navigation. The following messages may appear:

Navigation section: Messages

Message	Meaning
Heading locked	You are stationary or moving too slowly for an accurate heading to be computed. This message flashes alternately with the message Start moving . The direction dial arrow and any Information fields affected freeze. To unlock the heading, start moving faster than the <i>cutoff velocity</i> of 0.35 meters/second (1.26 kilometers/hour, or 0.78 miles/hour). NOTE — The heading is always locked when the Close-up screen is visible.
Heading not available	No heading can be calculated because you have not started moving (fast enough) since the GPS receiver was connected. This message alternates with the message Start moving until you begin to move.
No GPS	The TerraSync software is not connected to a GPS receiver.
Old navigation	GPS position information is temporarily unavailable (for example, because one or more satellites is obscured, or satellite geometry is poor). TerraSync still displays the most recent navigation information, but the direction dial arrow flashes.
Set your navigation target in the Map or Data section	You have not selected a navigation target. Select a target in the Map section or the Data section .
Start moving	Your speed is not sufficient for an accurate heading to be calculated: you are either stationary or are not moving fast enough. This message alternates with Heading not available , if you have not moved since connecting to GPS, or Heading locked , if you have slowed down too much since the last heading was calculated.

Navigation options form

- Fields

To display the Navigation options form, tap **Options** in the Direction Dial screen or the Close-up screen, and select Navigation Options.

Use this form to specify settings for the Navigation section.

The screenshot shows a mobile application interface for navigation settings. At the top, there is a status bar with icons for navigation, signal strength, battery, and a close button. Below the status bar, the text "Target: 2 Road Sign" is displayed. The main form is titled "Navigation" and has "OK" and "Cancel" buttons. The form is divided into two sections: "Close up" and "Lightbar".

Section	Field	Value
Close up	Range:	5.00 m
	Style:	Target-centered
Lightbar	Mode:	Chase
	Inner Lightbar Spacing:	0.5 m
	Outer Lightbar Spacing:	15 m
	Look Ahead Time:	0.5s

Navigation options form: Fields

Field	Description	Default
Range	The distance from the target to activate the Close-up screen. Enter a value to activate the Close-up screen at that distance, or select None to stop the Close-up screen from ever appearing.	5.00 m
Style	The style for the Close-up screen. The options are: <ul style="list-style-type: none">• Target-centered The target remains still in the center of the screen and your GPS position is displayed relative to it.• GPS-centered Your GPS position remains still in the center of the screen and the target is displayed relative to it.	Target-centered
Mode	The lightbar mode. The options are: <ul style="list-style-type: none">• Chase The center of the lightbar represents your current heading, and the lit arrow icons represent the direction of the cross-track line.• Center The center of the lightbar represents the direction of the cross-track line, and the lit arrow icons represent your current heading.	Center

Navigation options form: Fields (Continued)

Field	Description	Default
Inner Lightbar Spacing	The amount of cross-track error that each small inner arrow icon represents.	0.5 m
Outer Lightbar Spacing	The amount of cross-track error that each large outer arrow icon represents. This value must be greater than or equal to the value that you set for the inner lightbar spacing.	15 m
Look Ahead Time	<p>The lightbar display gives guidance for your predicted position, not your current position. Providing feedback for your predicted position helps you to correct your heading before you move too far off track.</p> <p>The look ahead time specifies how far into the future the lightbar should predict your position. The look ahead time must be short enough to ensure accurate and timely feedback, but must also be long enough to prevent the lightbar from recalculating the prediction too often. If the look ahead time is too short, the lightbar recalculates your position and changes the display feedback too quickly for you to respond with appropriate course corrections.</p>	0.5 s

Status section

To open the Status section, tap the Section list button and select Status.

Use this section to view information about external connections, including the GPS receiver and any real-time differential correction source.

The Status section has nine subsections:

- Skyplot
- Satellite information
- Plan
- Receiver
- Real-time
- Sensor
- Comms
- UTC Time
- About

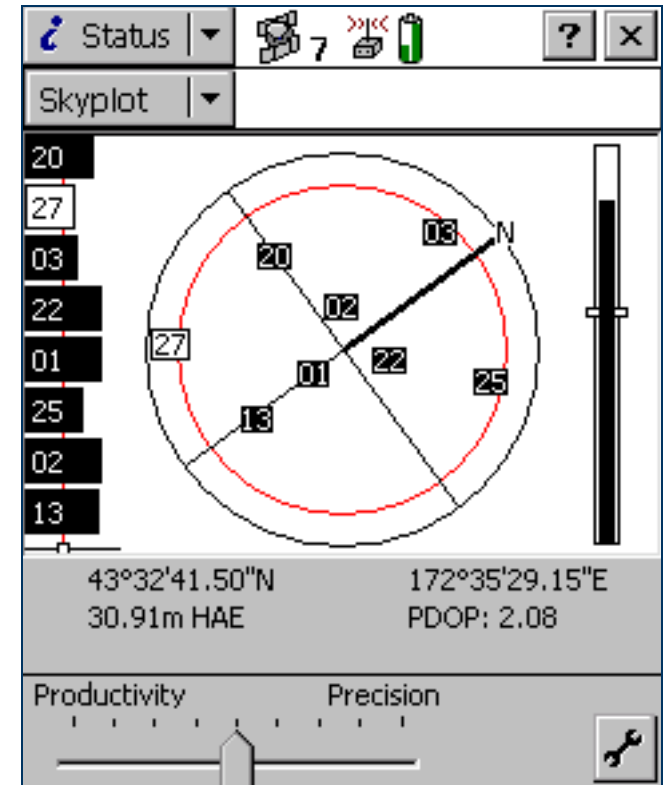

Skyplot

- Information fields
- Message line
- Setup area

The Skyplot graphical screen is the default screen displayed when you open the Status section. It provides a graphical display of the satellites available to the receiver.

To display the Skyplot when another screen in the Status section is visible, tap the Subsection list button and select Skyplot.

The Skyplot screen includes:

- Skyplot
- SNR graph
- Satellite geometry indicator

The following also appear at the bottom of the screen:

- Information fields
- Message line
- Setup area

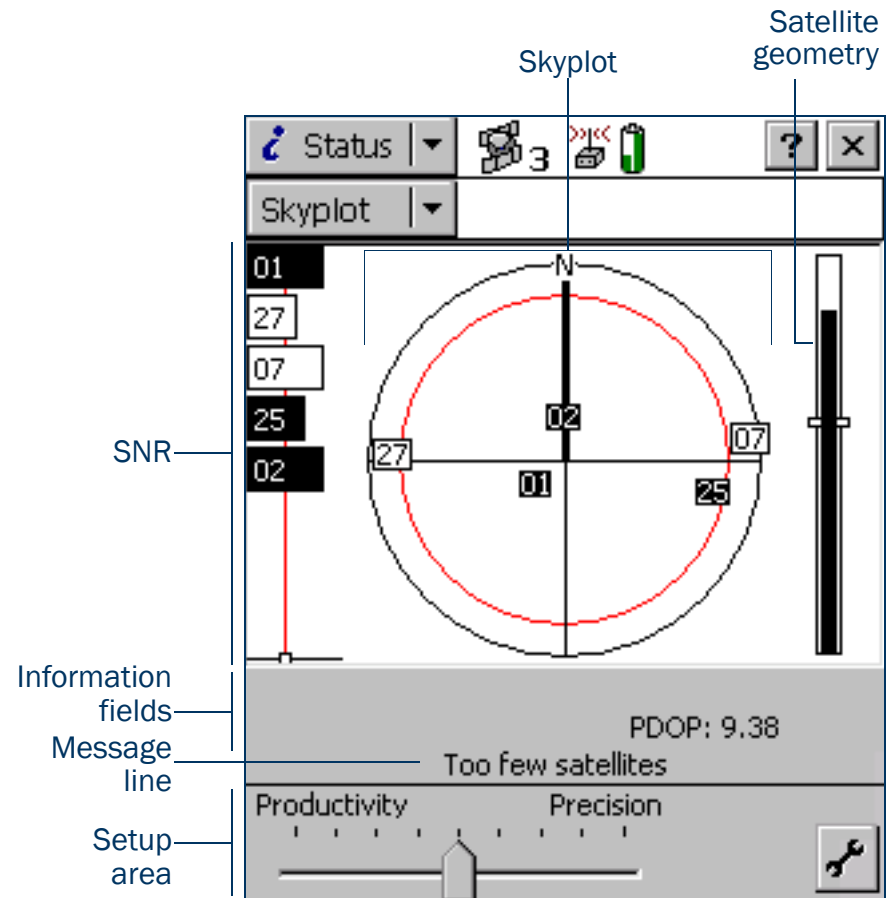

Skyplot

The black outer circle represents the **horizon** (at 0°). The inner circle, which is red on a color screen, represents the configured **Min Elevation**. When the minimum elevation value is changed, the inner circle of the skyplot changes diameter accordingly.

If the minimum elevation is increased, the inner circle gets smaller and only those satellites higher in the sky are used to compute GPS positions. If the minimum elevation is decreased, the inner circle gets larger, and satellites closer to the horizon are included when GPS positions are computed.

Numbered boxes represent the satellites currently available to the TerraSync software. The satellites near the center of the circle are higher in the sky (overhead), while those toward the edge are closer to the horizon. The location of a satellite can be determined by noting its direction (N, S, E, W) and its approximate elevation in the skyplot.

Satellites shown as filled black boxes are currently being used by the TerraSync software to compute GPS positions. Satellites shown as white boxes are being tracked, but are not being used to compute positions. Satellites shown without boxes are available, but are not being tracked. If a **WAAS** or **EGNOS** satellite is being tracked, its location is indicated by this icon: .

When you tap the skyplot, a tooltip appears, showing details about the area you have tapped. For more information, see **Tooltips**.

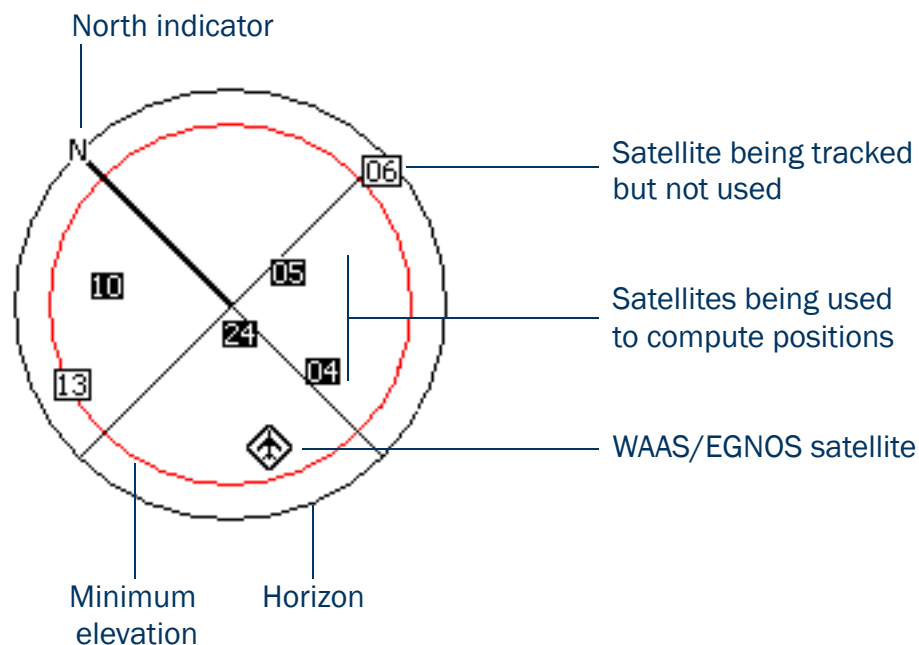

The skyplot rotates (like a compass) to indicate the direction that you are travelling in. Your direction is calculated from the last GPS positions received. If no positions have been received recently, the direction shown may not be correct.

NOTE — The skyplot only rotates if you are moving.

When you turn the receiver on, it begins to track visible satellites and to calculate the current position. Once the first position is displayed, subsequent positions are updated once per second.

TIP — If no positions are computed, look for obstructions that might be blocking satellite signals. Move away from any possible obstructions. If the receiver is still not computing positions, see [Troubleshooting](#).

SNR graph

The SNR bar graph on the left of the [Skyplot screen](#) is a graphical representation of the signal quality of each satellite that the GPS receiver is currently tracking. A black bar represents a satellite with a signal strength above the configured minimum level. An empty bar represents a satellite that is not being used to compute GPS positions because its signal strength is below the configured minimum level.

The vertical red line shows the configured minimum SNR value.

NOTE — If the connected receiver is a 5700 or 5800 receiver, the red line does not appear, because these receivers do not use minimum SNR values.

When you tap the SNR graph, a tooltip appears, showing details about the area you have tapped. For more information, see [Tooltips](#).

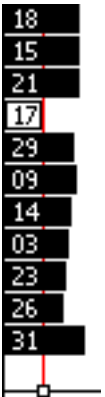

Satellite geometry indicator

The satellite geometry indicator on the right of the **Skyplot screen** is a graphical representation of the overall quality of the GPS positions computed. The white horizontal bar shows the configured minimum quality value, and the level of black inside the indicator shows the current quality value.

When you tap the satellite geometry indicator, a tooltip appears, showing details about the area that you tapped. For more information, see **Tooltips**.

The quality of the computed positions is a function of the geometry of the visible satellites (how they are positioned in the sky relative to each other and you). When the satellites are well spaced, and cover a large portion of the sky, the GPS receiver can compute accurate positions and the level inside the indicator is high. If satellites are grouped together in the sky, the precision of the computed positions is reduced, and the level inside the indicator is low.



Tooltips

When you tap any of the elements in the Skyplot screen, a tooltip appears. The tooltip provides detailed information about the element that you tapped.

Skyplot screen: Tooltips



Skyplot screen element	Tooltip
Bar on SNR graph	Satellite PRN and SNR value
White box on indicator below SNR graph	Configured minimum SNR value
Geometry indicator	Current PDOP or HDOP value
Horizontal bar on geometry indicator	Configured maximum PDOP or HDOP value
Satellite on skyplot	Satellite PRN, SNR value, elevation and bearing
Inner circle on skyplot	Configured minimum elevation value

Information fields

Information fields show the current GPS position and settings.

NOTE — If the field computer's screen uses a landscape orientation, the information fields appear on the right of the Skyplot screen.

Skyplot screen: Information fields

Display	Description
GPS position	<p>The current GPS position is displayed in terms of the currently configured coordinate system and datum. To change this configuration, use the Coordinate System form in the Setup section.</p> <p>NOTE — Positions viewed on the screen are not saved. To save them, open a data file and start a feature.</p>
PDOP	<p>The Position Dilution of Precision (PDOP) is a numeric value representing the satellite geometry. If you set a Max PDOP value, and the PDOP rises above the value you set, the TerraSync software stops computing positions. To set the maximum PDOP value, use the GPS slider in the Setup area, or tap the Setup button  to open the GPS Settings form.</p> <p>This field only appears if you have configured a maximum PDOP.</p>
HDOP	<p>The Horizontal Dilution of Precision (HDOP) represents the horizontal component of the PDOP. If you set a Max HDOP value, and the HDOP rises above the value you set, the TerraSync software stops computing positions. To set the maximum HDOP value, tap the Setup button  to open the GPS Settings form.</p> <p>This field only appears if you have configured a maximum HDOP.</p>

Message line

The message line below the graphical **Skyplot screen** and the **Satellite information screen** displays any error or warning messages. Messages only appear when there is a problem or a condition you should be aware of. For example, if the satellite geometry is good, no message appears; when it is poor, a message appears.

Skyplot and Satellite information screens: Messages

Message	Meaning
GPS disconnected	The GPS receiver is not connected.
Attempting to connect to GPS receiver	The TerraSync software is trying to establish a connection with the GPS receiver. This message appears when you start TerraSync, and whenever you try to reconnect to GPS.
Antenna is not connected to GPS receiver	The GPS receiver cannot detect the antenna, or the antenna cable is not connected to the GPS receiver.
Heading locked	The GPS receiver is stationary or is moving too slowly to calculate an accurate heading. When the heading is locked, the skyplot does not rotate.
Old position	The receiver has stopped computing positions, so the GPS position displayed in the Information fields is not the current position. This message alternates with either the Poor satellite geometry message or the Too few satellites message.
Poor satellite geometry	The PDOP or HDOP is higher than the level you specified in the GPS Settings form . NOTE — When the geometry of the satellites is poor, the satellite icon in the Status bar flashes. This icon is always visible, regardless of which section you are in.
Too few satellites	The GPS receiver is not tracking enough satellites to compute a GPS position. NOTE — When there are too few satellites to compute GPS positions, the number below the satellite icon in the Status bar flashes. This icon is always visible, regardless of which section you are in.

Setup area

The Setup area appears at the bottom of the **Skyplot screen** and the **Satellite information screen**. It shows the current GPS settings. The Setup area has two modes: Slider and Custom.

In **Slider** mode, the Setup area displays a slider bar. The position of the slider bar indicates the current GPS settings. The GPS slider makes it easy for you to choose between productivity and precision, without needing to know the best values for each setting.

TIP — The default position in the middle of the slider bar is the most productive setting at which the precision specifications of the GPS receiver are met.

To change GPS settings in Slider mode, move the slider bar to the left or right. The slider duplicates the GPS slider in the Setup section's **GPS Settings form**, so any changes you make to the slider position in the Setup area are also made in the GPS Settings form.

NOTE — Slider mode is not available if a base data file is open.

In **Custom** mode, the Setup area shows the configured limits for PDOP or HDOP, elevation, and SNR. To change to Custom mode, tap the Setup button  to open the **GPS Settings form**. Then clear the Slider check box.

Satellite information

- Columns
- Information fields
- Message line
- Setup area

To display the Satellite information screen, tap the Subsection list button and select Satellite Info.

Use the Satellite information screen to view information about satellites in text form.

As in the Skyplot screen, the following appear at the bottom of the screen:

- Information fields
- Message line
- Setup area

The screenshot shows the 'Sat Info' screen. At the top, there is a 'Status' dropdown menu and a signal strength indicator showing 5 bars. Below this is a 'Sat Info' dropdown menu. The main area contains a table with the following data:

	PRN	L1 SNR	L2 SNR	Elev	Br (T)
●	04	16.1	12.8	↑ 40°	125°
●	05	16.1	4.5	↓ 56°	297°
○	06	6.18	2.8	↑ 14°	243°
●	10	16.5	7.68	↓ 42°	8°
○	13	5.97	4.89	↓ 9°	118°
●	24	20.3	9.1	↑ 75°	159°
●	30	12.1	13.7	↓ 42°	243°

Below the table, there are two status indicators: 'Almanac: 6/16/03' and 'PDOP: 2.08'. At the bottom, there is a 'Productivity' and 'Precision' slider with a house icon in the center, and a wrench icon for settings.

Satellite information screen: Columns

Column	Description
Use indicator	This column displays a filled circle (●) for a satellite that is being used to calculate positions, and an empty circle (○) for any satellite that is visible but is not being used to calculate positions. For example, a visible satellite may not be used because it is below the configured minimum elevation. Satellites with no circle are available, but are not being tracked by the TerraSync software.
PRN	The pseudorandom number of each satellite. A satellite is identified by its unique PRN.
L1 SNR	The current signal-to-noise ratio of the L1 signal from each satellite. A satellite that is below the configured Min SNR is not used to compute positions.
L2 SNR	The current signal-to-noise ratio of the L2 signal from each satellite. This column only appears if the connected GPS receiver is a 5700 or 5800 receiver. NOTE — If a satellite is marked as “unhealthy” by the GPS Control Segment, the characters U/H appear in the SNR columns for that satellite.
Elev	The current elevation above the horizon of each satellite. A satellite that is below the configured Min Elevation is not used to compute positions.
Br(T) or Br(M)	The current bearing to each satellite. This bearing is shown relative to either true north (T) or magnetic north (M), as determined by the currently configured North Reference .

Information fields

Information fields show the current GPS position and settings.

NOTE — If the field computer's screen uses the landscape orientation, the information fields appear to the right of the Satellite information screen.

Satellite information screen: Information fields

Display	Description
Almanac	The date of the last almanac received from satellite broadcasts.
PDOP	The current PDOP value. This field only appears if you have configured a maximum PDOP.
HDOP	The current HDOP value. This field only appears if you have configured a maximum HDOP.

Plan

- Buttons
- Fields



To display the Plan screen, tap the Subsection list button and select Plan.

The Plan screen lets you plan your data collection session while you are in the field. You can view an animated skyplot and DOP graph for your current position over the next 12 hours, and use these to plan data collection around the times of the day when satellite geometry is best. For more information, see [Planning a data collection session](#).

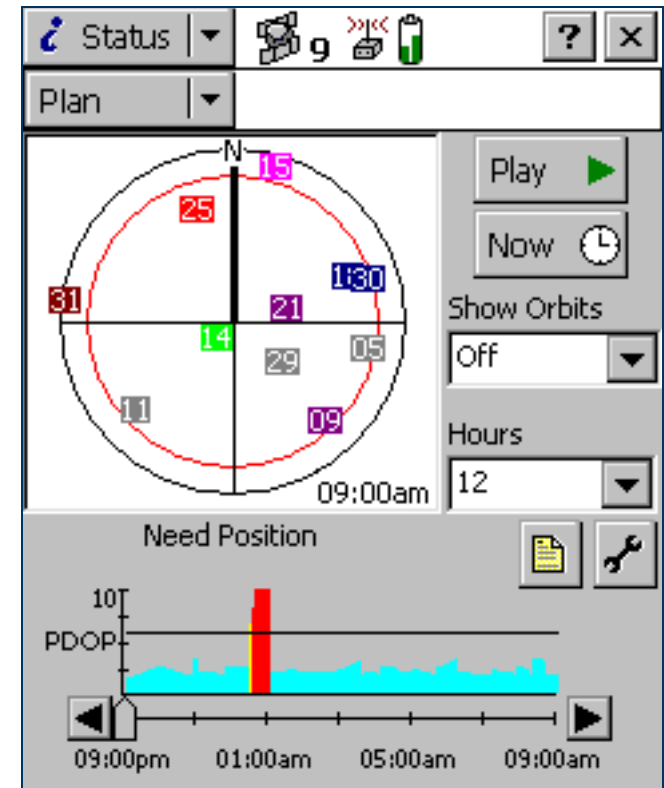
The Plan screen includes a [Planning skyplot](#), [Message line](#), and a [DOP graph](#).

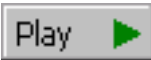
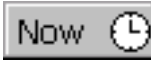

Plan screen: Buttons

Button	Description
 Play	Tap Play to begin playback of a session, or to resume playback after pausing. When the session is playing, the button changes to the Pause button. Tap it to temporarily pause playback. At the end of playback, the button changes to the Home button. Tap it to return to the beginning of the session, ready for playback again.
 Now	Tap Now to set the session to the current time. The time shown on the skyplot and position of the slider bar on the DOP graph change to match the current time.
 Report	Tap the Report button to create a text file containing details of the current planning session.
 Setup	Tap the Setup button to open the GPS Settings form from the Setup section.

Plan screen: Fields

Field	Description
Show Orbits	Use this field to select the type of orbit information to display on the skyplot. The options are: <ul style="list-style-type: none">• Off Do not show any orbit information.• Trails Show an orbit trail for each satellite. During session playback, a satellite's trail plots where the satellite has been in this session. The trail is a solid line in the same color that is used to represent the satellite.• Trajectories Show an orbit trajectory for each satellite. At the beginning of playback, each satellite's entire trajectory is visible, showing where it will travel during the session. The trajectory is a dashed line in the same color that is used to represent the satellite. During session playback, each satellite erases its trajectory as it moves over the plotted positions.
Hours	Select an option from this field to specify how many hours the planning session will cover. The session begins at the last full hour before the current time. For example, if the time is 10:56, the session starts at 10:00. A session can cover up to twelve hours.

Planning skyplot

The planning skyplot is similar to the skyplot shown in the [Skyplot subsection](#). The outer black circle indicates the horizon, the inner red circle represents the minimum elevation that you have set. Each satellite that is in view is represented by a box containing the satellite's **pseudorandom number** (PRN). Each satellite is colored for easy identification.

NOTE — Unlike the main skyplot, the planning skyplot shows *all* visible satellites, even if they are below the configured minimum elevation or their current SNR value is too high. To check which satellites are currently being tracked, use the main [Skyplot](#).

The time displayed in the lower right corner of the planning skyplot indicates the exact time that the skyplot is showing. It matches the position of the slider bar on the [DOP graph](#).

When you open the Plan section, the planning skyplot's orientation matches the current heading shown in the main [Skyplot](#). The planning skyplot does not rotate as your heading changes, but if your heading becomes locked (for example, if you are not moving fast enough for an accurate heading to be calculated) then the planning skyplot's orientation is updated to this locked heading.

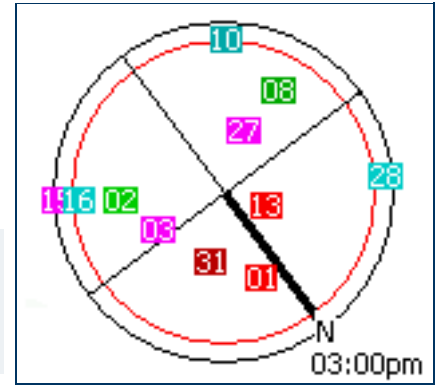

DOP graph

The DOP graph shows the projected PDOP or HDOP values over the specified time period.

The horizontal line indicates the currently configured maximum PDOP or HDOP.

The slider bar shows the time period that is selected in the **Hours** list. Drag the slider bar across the slider, or tap the left or right arrow button, to view the skyplot for a specific time. As the slider control's position changes, the skyplot and time display change to match the selected time.

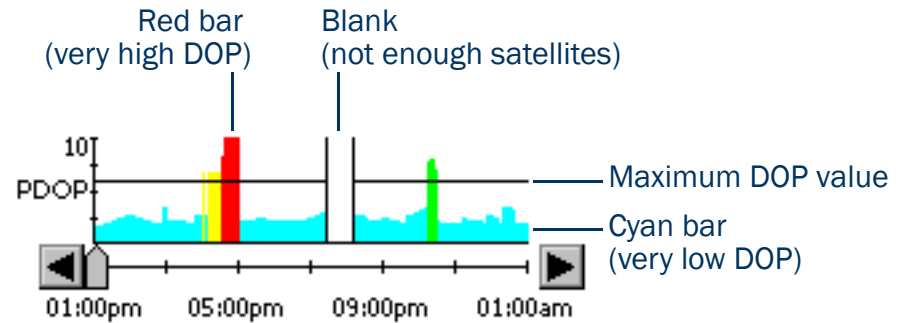

Appearance	PDOP	HDOP
Cyan bar	< 4	< 2.5
Green bar	4 – 6	2.5 – 4
Yellow bar	6 – 8	4 – 5.5
Red bar	> 8	> 5.5
Blank with black left and right borders	Not enough satellites are available to compute a position.	

Message line

The message line below the planning skyplot in the **Plan screen** displays any error or warning messages. Messages only appear when there is a problem or a condition you should be aware of. The following messages may appear:

Plan screen: Messages

Message	Meaning
Recording almanac	TerraSync is downloading an almanac from the connected GPS receiver.
Need almanac	TerraSync does not have a current almanac of satellite locations.
Need position	The GPS receiver has stopped computing positions.
Heading locked	The GPS receiver is stationary or moving too slowly to calculate an accurate heading. The rotation of the planning skyplot does not reflect the current heading.



Planning a data collection session

TIP — If the message **Need almanac** or **Recording almanac** appears in the message line, TerraSync does not have a current almanac of satellite positions. This may occur the first time you connect to GPS after you install TerraSync, or if the GPS receiver has not been used for a while. A current almanac is important when planning a data collection session. Wait until the message disappears before using the Plan section.

Before you use the Plan section, tap the Setup button  to open the **GPS Settings form** from the Setup section, and configure GPS settings to your data collection requirements. Any changes you make are reflected in the planning skyplot and DOP graph in the **Plan subsection**. For example, if you decrease the minimum elevation, the red circle on the planning skyplot gets larger.

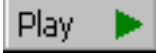
If required, select an option from the Show Orbits list to display orbit trails (past locations within the session) or trajectories (future locations within the session) for each satellite.

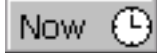
Tap the **Play** button  to play back the session automatically. The **Play** button changes to a **Pause** button, the satellites move in the skyplot, and the position of the slider on the DOP graph changes to match the time shown on the skyplot. Tap the **Pause** button at any time to pause playback.

Tap the **Now** button  to show the current time, drag the slider on the **DOP graph** to fast forward to a time of interest, or use the **Back**  and **Forward**  buttons to move in increments of ten minutes. The skyplot changes to show the constellation for the time indicated by the slider position.

To zoom in on a particular time period, use the **Pause** button, slider, or the **Back** and **Forward** buttons to stop playback at the time of interest. Select a value from the Hours list. The DOP graph zooms in to show DOP values for the specified number of hours ahead of the selected time.

NOTE — The planning skyplot shows all possible satellites, using the almanac received from satellite broadcasts. It does not take into account any obstructions, such as buildings or tree canopy, that may block satellites from your line of sight.

Receiver

- Fields

To display the Receiver screen, the Subsection list button and select Receiver. Use this screen to view information about the connected GPS receiver.

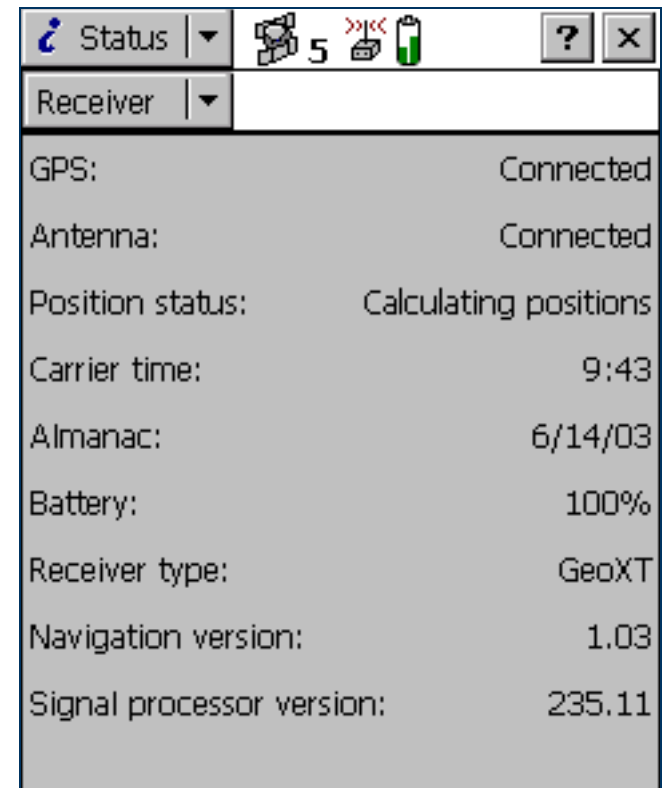

Receiver screen: Fields

Field	Description
GPS	<p>The current status of the GPS receiver connection. The options are:</p> <ul style="list-style-type: none">• Connected TerraSync is connected to the GPS receiver.• Attempting to connect to GPS TerraSync is trying to connect to the receiver. If this message appears, no other fields appear.• GPS is disconnected The receiver has been disconnected from TerraSync. If this message appears, no other fields appear.• No GPS detected. Check cables, batteries etc TerraSync has failed to detect the receiver, because it is not connected to the port specified in the GPS Settings form, or has no power. If this message appears, no other fields appear.
Antenna	<p>The current status of the antenna connection. The options are:</p> <ul style="list-style-type: none">• Connected TerraSync is connected to a GPS receiver, and the receiver is connected to a GPS antenna.• Not connected No antenna is connected. The antenna icon also appears in the Status bar.
Position status	<p>An indicator of the GPS status. The options are:</p> <ul style="list-style-type: none">• Calculating positions The receiver is computing GPS position fixes. The current satellite constellation is therefore acceptable.• Poor satellite geometry The current PDOP or HDOP value is greater than the maximum value, so The GPS receiver is not computing GPS positions.• Too few satellites The GPS receiver has acquired satellites, has not acquired enough satellites to compute a position.• Unavailable No position is available. For example, there may be no antenna connected to the receiver.

Receiver screen: Fields (Continued)

Field	Description
Carrier time	The time elapsed, in minutes and seconds, since the TerraSync software began logging the current block of carrier data. If TerraSync is not logging carrier phase data, this field shows N/A.
Almanac	The date of the almanac appears in this field.
Battery	The current level of charge in the GPS receiver's battery. This value appears as a percentage.
Receiver type	The name of the receiver model currently connected to the field computer. The TerraSync software shows the internal name supplied by the receiver, which may not exactly match the name you use for the receiver.
Navigation version	The version number of the navigation firmware that is installed in the connected GPS receiver.
Signal processor version	The version number of the signal processing firmware that is installed in the connected GPS receiver.
LandStar ID	<p>The activation code for the LandStar satellite differential service. You need this code when contacting your LandStar provider for activation.</p> <p>This field only appears if the connected receiver supports real-time corrections from a satellite differential service.</p>
OmniSTAR ID	<p>The activation code for the OmniSTAR satellite differential service. You need this code when contacting your OmniSTAR provider for activation.</p> <p>This field only appears if the connected receiver supports real-time corrections from a satellite differential service.</p>

Real-time

To view real-time information, tap the Subsection list button then select Real-time.

By default, the real-time screen that appears is the **Real-time Summary screen**. Depending on the real-time configuration, the following detailed status screens may also be available:

- **External Source Status screen**
- **BoB Status screen**
- **Integrated Beacon Status screen**
- **Integrated Satellite Status screen**
- **Integrated WAAS Status screen**
- **Integrated RTK Radio Status screen**

Use these screens to view information about the real-time correction sources you have set up.

Use the Status Mode button to move between the real-time status screens. When you tap the Status Mode button, a list of status screens appears. Select an option to open the corresponding screen.

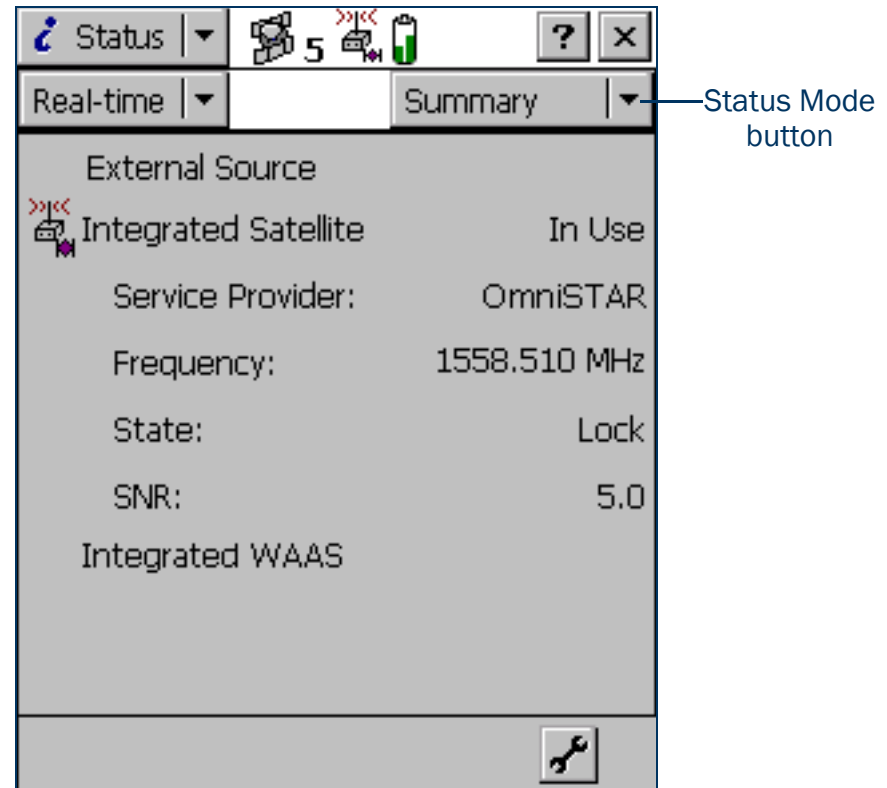

Real-time Summary screen

The Real-time Summary screen contains a heading for each real-time source you have set up. The heading shows the name of the source. The order of the real-time sources matches the order of your choices in the **Real-time Settings form** in the Setup section.

The real-time source currently in use for real-time corrections has an icon beside its name. The icon used matches the icon that appears in the status bar, to provide a quick indicator of the real-time source in use.

If no icon is shown, the TerraSync software is waiting for real-time corrections to resume, or it is logging uncorrected positions. The real-time icon in the status bar also flashes to indicate that real-time corrections are not available.

Brief summary information on each configured real-time source is included in this screen:

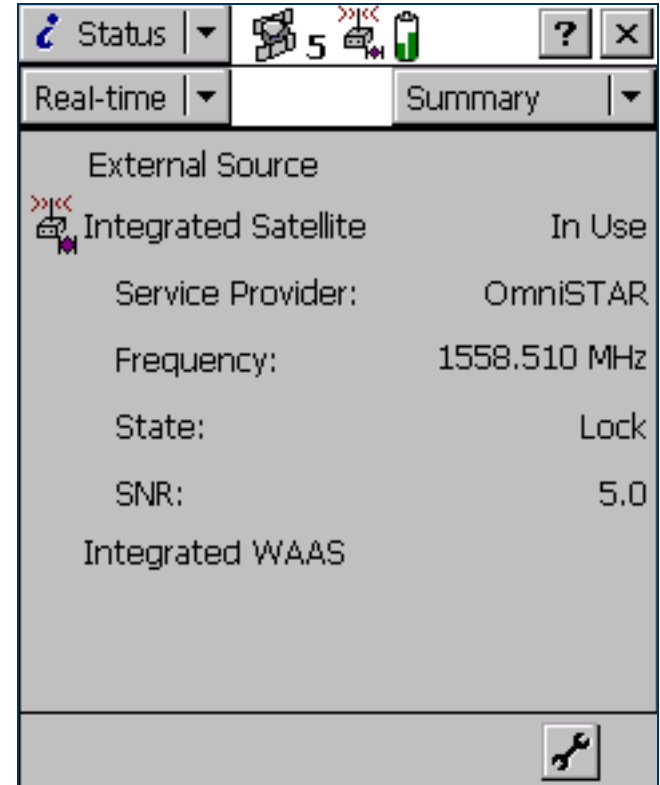

- **External Source summary fields**
- **BoB summary fields**
- **Integrated Beacon summary fields**
- **Integrated Satellite summary fields**
- **WAAS summary fields**
- **RTK Radio summary fields**
- **RTK summary fields**



For full status information on any source you have configured, tap the Status Mode list button and select the source name.

The screen also includes a **Setup area** for quick access to real-time settings.

Real-time Summary screen: External Source summary fields

Field	Description
External Source	<p>The status of the External Source real-time source. The options are:</p> <ul style="list-style-type: none"> • In use This source is being used for real-time corrections. • Waiting This source is configured but a lower-ranked choice is currently in use. The source's status is being monitored and the TerraSync software will switch to this source if it becomes available and is the highest-ranked available source. • (none) This source is configured but is not being monitored or used. <p>If External Source is the real-time source that is in use, the real-time External icon  (if the external source is a single base) or the real-time VRS icon  (if the external source is a virtual reference station) appears to the left of the field name.</p>

Real-time Summary screen: BoB summary fields

Field	Description
BoB	<p>The status of the Beacon-on-a-Belt (BoB™) receiver that is configured as an external source. The options are the same as the options for the External Source field.</p> <p>If BoB is the real-time source that is currently in use, the real-time BoB icon  appears to the left of the field name.</p>
Frequency	The current beacon frequency being tracked or locked on to by the BoB receiver.
State	The real-time operating status of the BoB receiver.
SNR	The signal-to-noise ratio of the beacon signal that is being monitored.

Real-time Summary screen: Integrated Beacon summary fields

Field	Description
Integrated Beacon	<p>The status of the Integrated Beacon real-time source. The options are the same as the options for the External Source field, with the addition of this option:</p> <ul style="list-style-type: none"> Not supported The connected GPS receiver does not support real-time corrections from this source. <p>If Integrated Beacon is the real-time source that is in use, the real-time beacon icon  appears to the left of the field name.</p>
Frequency	The current beacon frequency being tracked or locked on to.
State	The real-time operating status of the integrated beacon receiver.
SNR	The signal-to-noise ratio of the integrated beacon signal that is being monitored.

Real-time Summary screen: Integrated Satellite summary fields

Field	Description
Integrated Satellite	<p>The status of the Integrated Satellite real-time source. The options are the same as the options for the Integrated Beacon field.</p> <p>If Integrated Satellite is the real-time source that is in use, the real-time satellite icon  appears to the left of the field name.</p>
Service Provider	The name of the satellite differential service provider that the satellite in use belongs to.
Frequency	The current satellite frequency being tracked or locked on to.
State	The real-time operating status of the integrated satellite receiver.
SNR	The signal-to-noise ratio of the satellite signal that is being monitored.

Real-time Summary screen: WAAS summary fields

Field	Description
Integrated WAAS	<p>The status of the Integrated WAAS real-time source. The options are the same as the options for the Integrated Beacon field.</p> <p>If Integrated WAAS is the real-time source that is in use, the real-time WAAS icon  appears to the left of the field name.</p>
SNR	The signal-to-noise ratio of the WAAS/EGNOS satellite signal that is being monitored.

Real-time Summary screen: RTK Radio summary fields

Field	Description
RTK Radio	<p>The status of the Integrated RTK Radio real-time source. The options are the same as the options for the Integrated Beacon field.</p> <p>If RTK Radio is the real-time source that is in use, the RTK icon  appears to the left of the field name.</p>
Frequency	The frequency that the RTK radio is listening to.

Real-time Summary screen: RTK summary fields

Field	Description
Frequency	The frequency that the RTK radio is listening to.
State	<p>The RTK state. The options are:</p> <ul style="list-style-type: none">• Initializing• Initialized• Link down• Waiting for base info

Real-time Summary screen: RTK summary fields (Continued)

Field	Description
Position is	The type of RTK position being logged. The options are: <ul style="list-style-type: none"><li data-bbox="413 201 564 235">• Roving<li data-bbox="413 246 550 280">• Static

Setup area

There is a Setup area at the bottom of each screen in the Status section's Real-time subsection. The Setup area provides a shortcut to the Setup section's **Real-time Settings form**. To configure real-time settings, tap the Setup button  in the Setup area. The Real-time Settings form appears. Make any changes you require, and then tap **OK** to return to the real-time status screen.

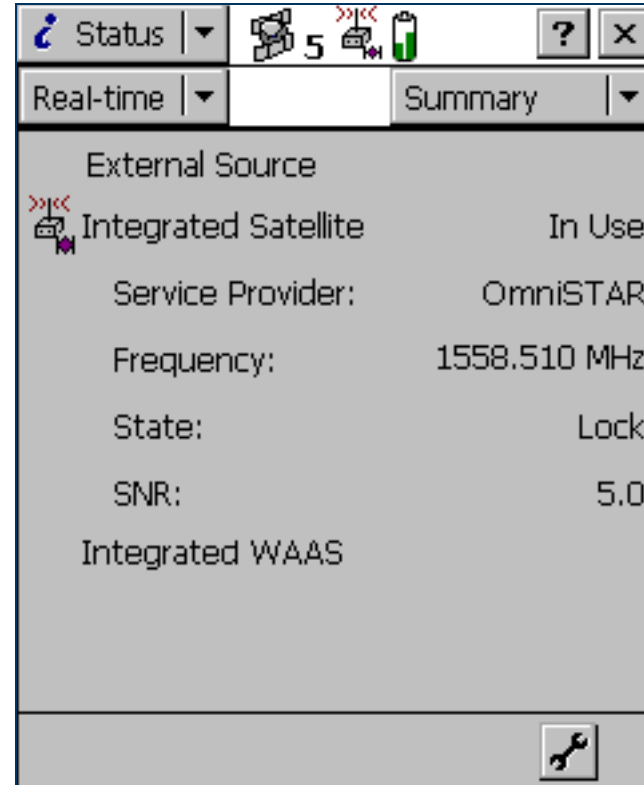

External Source Status screen

- Fields
- Setup area

To display the External Source Status screen, open the **Real-time subsection**, tap the Status Mode button, and select External Source. This screen shows detailed information about the external real-time correction source you have set up.

NOTE — If you have configured a BoB receiver as the external source, the **BoB Status screen** is available instead of the External Source screen.

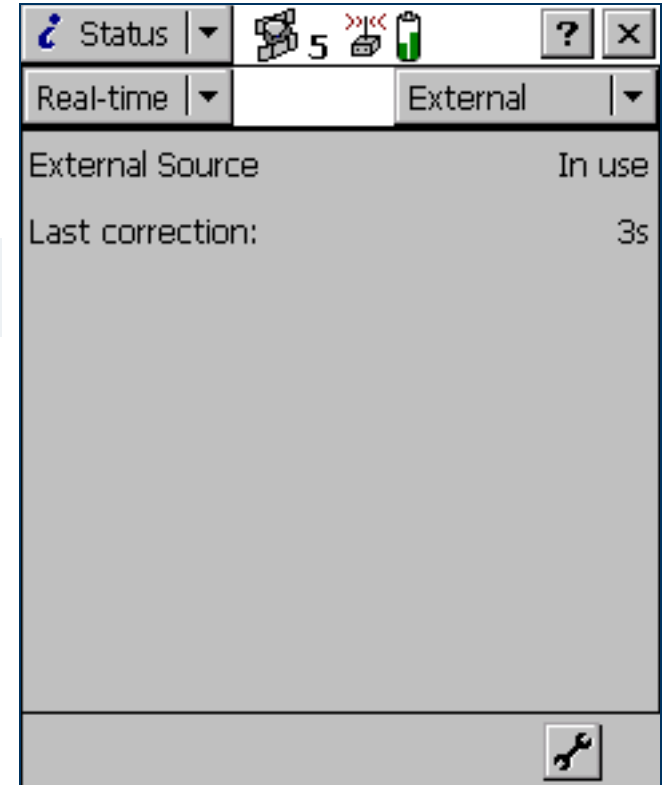

External Source Status screen: Fields

Field	Description
External Source	<p>The status of this real-time source. The options are:</p> <ul style="list-style-type: none">• In use The external real-time source is currently being used to correct positions in real time.• Waiting A lower-ranked choice is currently being used to correct positions in real time. The external source's status is being monitored and the TerraSync software will switch to the external source if it becomes available and it is the highest-ranked available source.• Not in use The external real-time source is set up but is not currently being used for real-time corrections.
Correction Type	<p>The type of VRS correction being received. The options are:</p> <ul style="list-style-type: none">• Network The VRS is providing a network solution, using corrections from more than one base station to calculate the position of the virtual reference station.• Single Station The VRS is operating in raw mode, and is using only one base station to provide RTCM corrections. <p>This field only appears if the external source is a virtual reference station (VRS).</p>
Connection Up-time	<p>The duration, in hours, minutes, and seconds, of the current VRS connection. This field only appears if the external source is a VRS.</p>
Data Received	<p>The amount of data, in megabytes, kilobytes, or bytes as appropriate, that has been sent and received since the connection was established. This field only appears if the external source is a VRS.</p>
Last correction	<p>The time, in seconds, since the last correction message from this source was received.</p>

BoB Status screen

- Fields
- Setup area

To display the BoB Status screen, open the **Real-time subsection**, tap the Status Mode button, and select BoB.

This screen shows detailed information about the BoB receiver you have set up as an external real-time correction source.

NOTE — If you have configured an external source that is not a BoB receiver, the **External Source Status screen** is available instead of the BoB Status screen.

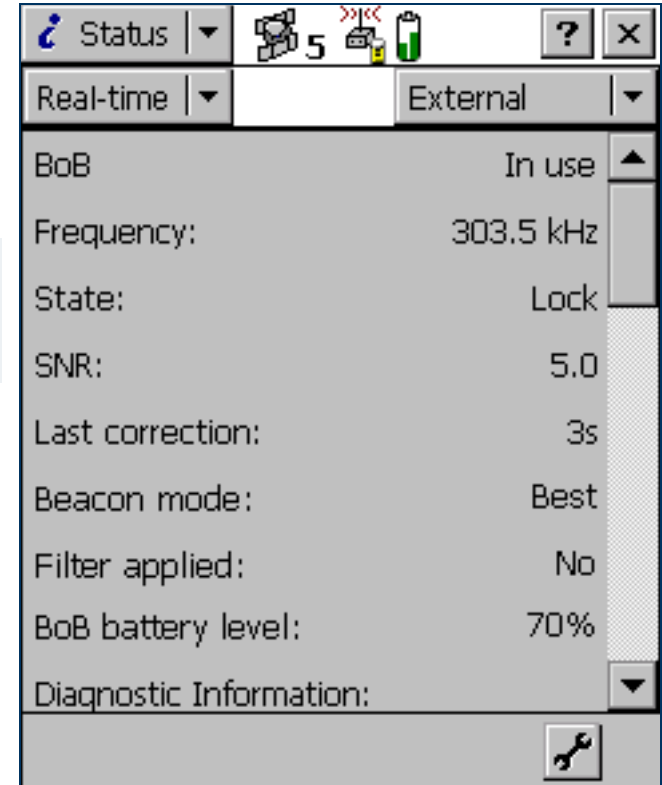

BoB Status screen: Fields

Field	Description
BoB	<p>The status of the BoB receiver. The options are:</p> <ul style="list-style-type: none">• In use The BoB receiver is currently being used to correct positions in real time.• Waiting A lower-ranked choice is currently being used to correct positions in real time. The BoB receiver status is being monitored and the TerraSync software will switch to BoB if it becomes available and it is the highest-ranked available source.• Not in use The BoB receiver is set up but is not currently being used for real-time corrections.• Not supported The connected GPS receiver does not support real-time corrections from a BoB receiver.
Frequency	<p>The current beacon station frequency being tracked or locked on to by the BoB receiver.</p> <p>TIP – Use the PC-BoB software to set the BoB frequency.</p>
State	<p>The state of the BoB receiver. The options are:</p> <ul style="list-style-type: none">• Search• Track• Lock• Idle• On• Off
SNR	<p>The signal-to-noise ratio, in decibels, of the beacon signal that the BoB receiver is monitoring.</p>
Last correction	<p>The time, in seconds, since the last correction message from this source was received by the GPS receiver.</p>

BoB Status screen: Fields (Continued)

Field	Description
Beacon mode	<p>The mode the BoB receiver is operating in. The options are:</p> <ul style="list-style-type: none">• Best The BoB receiver tracks the best frequency available and automatically switches frequency if a better signal is available.• Fixed The BoB receiver tracks only the frequency you specify in the PC-BoB software.
Filter applied	<p>This field specifies whether a filter has been applied to the list of frequencies the BoB receiver can track. The options are:</p> <ul style="list-style-type: none">• Yes• No
BoB battery level	<p>The remaining battery power of the BoB receiver, as a percentage.</p>
Diagnostic Information	<p>A heading used to group together fields that contain information for troubleshooting the BoB receiver signal.</p>
Error Rate	<p>The RTCM Word Error Rate, which shows the proportion of RTCM words that have parity errors. An error rate of less than 0.1 is acceptable.</p>
Input Level	<p>The intensity level of the electromagnetic field. This value should be between 10 and 100 dBuV/M.</p>
Data Rate	<p>The data modulation rate from the BoB receiver.</p>
Health	<p>The health of the BoB receiver signal. The options are:</p> <ul style="list-style-type: none">• Healthy• Unhealthy• Not tracked

Integrated Beacon Status screen

- Fields
- Setup area

To display the Integrated Beacon Status screen, open the **Real-time subsection**, tap the Status Mode button, and select Integrated Beacon.

This screen shows detailed information about the integrated beacon source you have set up.

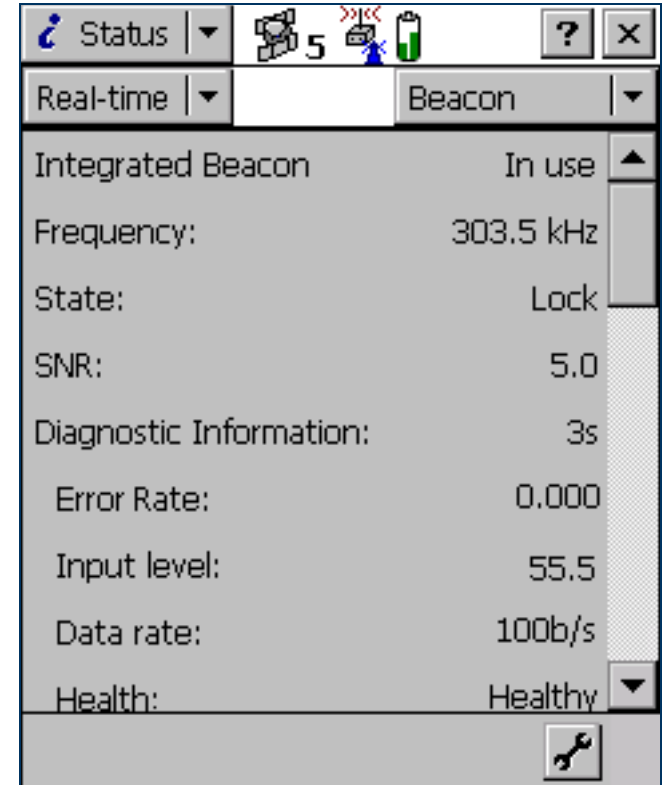

Integrated Beacon Status screen: Fields

Field	Description
Integrated Beacon	<p>The status of this real-time source. The options are:</p> <ul style="list-style-type: none"> • In use A beacon is currently being used to correct positions in real time. • Waiting A lower-ranked choice is currently being used to correct positions in real time. The beacon status is being monitored, and the TerraSync software will switch to the beacon source if it becomes available and it is the highest-ranked available source. • Not in use A beacon real-time source is set up but is not currently being used for real-time corrections. • Not supported The connected GPS receiver does not support real-time corrections from an integrated beacon receiver.
Frequency	The current beacon frequency being tracked or locked on to.
State	<p>The current state of the integrated beacon receiver. The options are:</p> <ul style="list-style-type: none"> • Search • Track • Lock • Idle • On • Off
SNR	The signal-to-noise ratio, in decibels, of the beacon station being tracked. An SNR above 6.0 dB indicates that the signal is usable.
Last correction	The time, in seconds, since the last correction message from this source was received by the GPS receiver.
Diagnostic Information	A heading used to group together fields that contain information for troubleshooting the beacon service.

Integrated Beacon Status screen: Fields (Continued)

Field	Description
Error Rate	The RTCM Word Error Rate, which shows the proportion of RTCM words that have parity errors. The error rate should be 0.1 or less.
Input Level	The intensity level of the electromagnetic field. This value should be between 10 and 100 dBuV/M.
Data Rate	The data modulation rate from the beacon.
Health	The health of the beacon signal. The options are: <ul style="list-style-type: none">• Healthy• Unhealthy• Not tracked

Integrated Satellite Status screen

- Fields
- Setup area

To display the Integrated Satellite Status screen, open the **Real-time subsection**, tap the Status Mode button, and select Integrated Satellite. This screen shows detailed information about the satellite differential service you have set up.

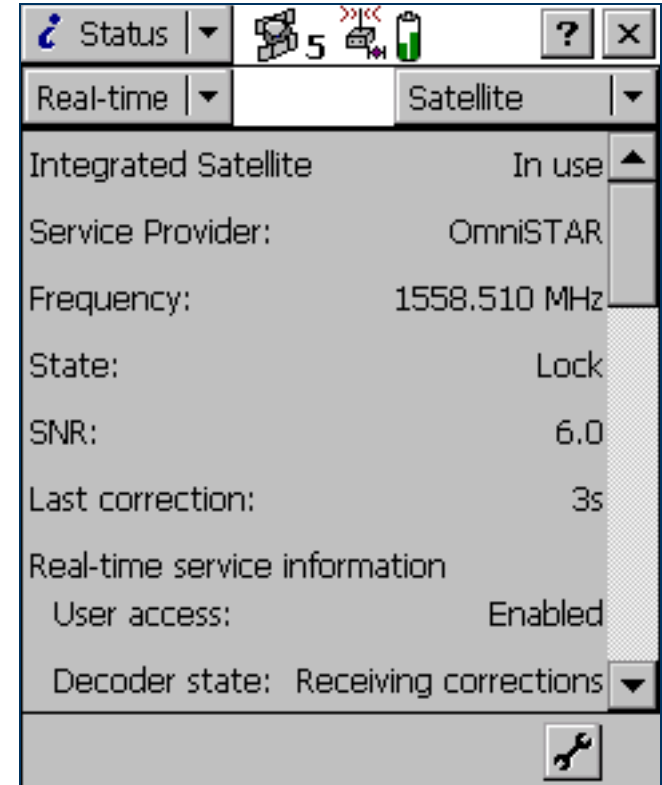

Integrated Satellite Status screen: Fields

Field	Description
Integrated Satellite	<p>The status of this real-time source. The options are:</p> <ul style="list-style-type: none">• In use The integrated satellite real-time source is being used to correct positions in real time.• Waiting A lower-ranked choice is currently being used to correct positions in real time. The satellite status is being monitored and the TerraSync software will switch to the satellite source if it becomes available.• Not in use An integrated satellite real-time source is set up but is not currently being used for real-time corrections.• Not supported The connected GPS receiver does not support corrections from an integrated satellite receiver.
Service Provider	<p>The name of the provider of the satellite differential service being used. The options are:</p> <ul style="list-style-type: none">• LandStar• OmniSTAR
Frequency	<p>The current satellite frequency being tracked or locked on to.</p>
State	<p>The current real-time state of the integrated satellite receiver. The options are:</p> <ul style="list-style-type: none">• Search• Track• Lock• Idle
SNR	<p>The signal-to-noise ratio, in decibels, of the selected satellite signal. An SNR above 3.0 dB indicates that the signal is usable.</p>
Last correction	<p>The time, in seconds, since the last correction message from this source was received by the GPS receiver.</p>

Integrated Satellite Status screen: Fields (Continued)

Field	Description
Real-time Service Information	A heading used to group together fields that contain information about the integrated satellite subscription.
User access	<p>This field specifies whether the selected correction service has been enabled for the GPS receiver. The options are:</p> <ul style="list-style-type: none"> • Enabled The service is enabled. • Disabled The activation has expired. • Unknown The service has not yet been activated on this receiver, or the receiver has not yet determined the activation status.
Decoder state	<p>The current status of the satellite activation. The options are:</p> <ul style="list-style-type: none"> • Initializing The real-time decoder is initializing. • Receiving corrections The decoder is providing corrections. • No recent data Real-time data has not been received from the decoder in the last 10 seconds. • Decoder unavailable The decoder is not available or is not operating correctly. • Decoder reset A reset has been detected in the decoder. • Invalid link The decoder is using a satellite link that is not valid for the subscription. • Invalid region The decoder is being used in a region that is not covered by the current subscription. • Update required The decoder requires an update from the master station before corrections can be provided. • No offshore The decoder is being used in a marine area but the current subscription does not provide for offshore operation.

Integrated Satellite Status screen: Fields (Continued)

Field	Description
Expiration	The date on which the satellite differential service subscription expires, or the time remaining until the subscription expires.
Diagnostic Information	A heading used to group together fields that contain information for troubleshooting the satellite service.
Quality figure	The percentage of error-free data received from the integrated satellite in the last data block. This value should be 90% or higher.
Age of sync	The number of seconds since the receiver decoded a data block from the satellite. If this value is greater than 3 seconds, the signal from the satellite may no longer be valid.
Decoder version	The version number of the satellite decoder in the GPS receiver.

Integrated WAAS Status screen

- Fields
- Setup area

To display the Integrated WAAS Status screen, open the **Real-time subsection**, tap the Status Mode button, and select Integrated WAAS.

This screen shows detailed information about the WAAS/EGNOS satellite differential service.

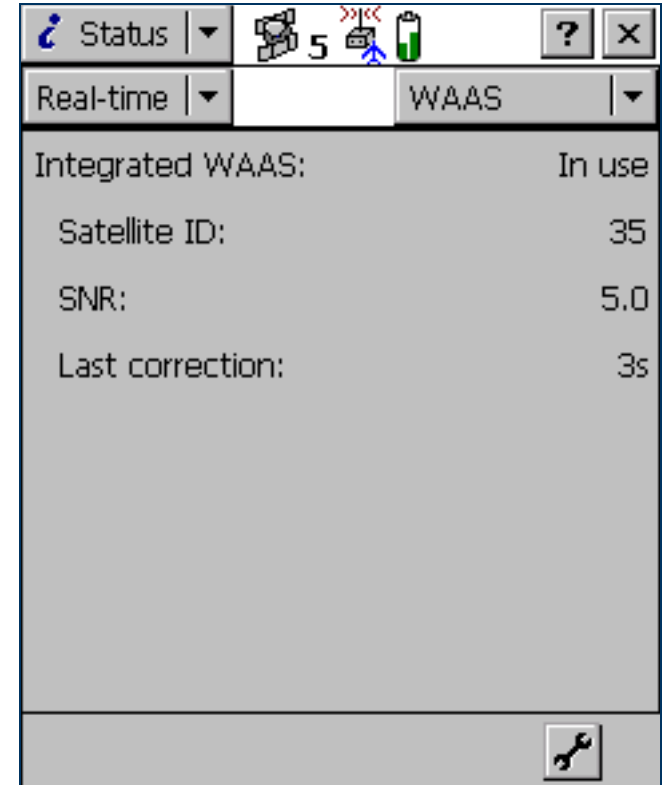

Integrated WAAS Status screen: Fields

Field	Description
Integrated WAAS	<p>The status of this real-time source. The options are:</p> <ul style="list-style-type: none">• In use The integrated WAAS real-time source is being used to correct positions in real time.• Waiting A lower-ranked choice is currently being used to correct positions in real time. The WAAS/EGNOS status is being monitored and the TerraSync software will switch to the WAAS/EGNOS source if it becomes available.• Not in use The integrated WAAS real-time source is set up but is not currently being used for real-time corrections.• Not supported The connected GPS receiver does not support corrections from an integrated WAAS/EGNOS receiver.
SNR	The signal-to-noise ratio, in decibels, of the selected WAAS/EGNOS satellite signal. An SNR above 3.0 dB indicates that the signal is usable.
Last correction	The time, in seconds, since the last correction message from this source was received by the GPS receiver.

Integrated RTK Radio Status screen

- Fields
- Setup area

To display the Integrated RTK Radio Status screen, open the **Real-time subsection**, tap the Status Mode button, and select RTK Radio.

This screen shows detailed information about the GPS receiver's internal RTK radio.

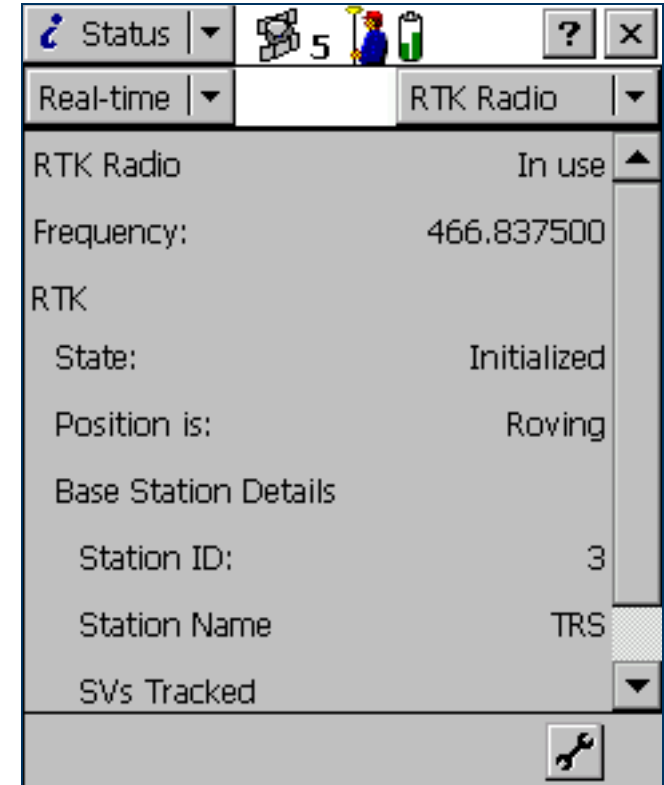

Integrated RTK Radio Status screen: Fields

Field	Description
RTK Radio	<p>The status of this real-time source. The options are:</p> <ul style="list-style-type: none"> • In use Data from the integrated RTK radio is being used to correct positions in real time. • Waiting The RTK radio is initializing. • Not supported The connected GPS receiver does not support corrections via an integrated RTK radio.
Frequency	The frequency that the RTK radio is listening to.
State	<p>The RTK state. The options are:</p> <ul style="list-style-type: none"> • No base station coordinates The integrated RTK radio has not yet received coordinate information from the base station. • Waiting for base info The integrated RTK radio is waiting for information from the base station radio. • Initializing The GPS receiver is performing RTK initialization. • Initialized RTK is initialized and in use. • Link down The integrated RTK radio is not receiving corrections from the base station radio.
Position is	<ul style="list-style-type: none"> • The type of RTK position being logged. The options are: • Roving A line or area feature is being logged. All positions that meet the required precision for roving mode are logged. • Static A point feature or vertex is being logged. Only the position with the best precision estimate is recorded. All other positions are discarded.
Station ID	The ID number that the base station uses to identify itself to rovers.
Station Name	The name of the base station.
SVs Tracked	The PRNs of the GPS satellites that the base station is tracking.

Sensor

- Fields

NOTE — The Sensor subsection does not appear in the **TerraSync Standard edition software**. The Standard edition software does not support external sensors.

To view sensor information, tap the Subsection list button and select Sensor.

There is a sensor status screen for each sensor that you can configure. Use these screens to view information about the external sensors that you have set up.

Use the Sensor Mode button to move between the sensor status screens. When you tap the Sensor Mode button, a list of sensors appears. Select an option to open the status screen for that sensor. If the sensor is not enabled or connected, the message **Sensor not active** appears instead of information fields.

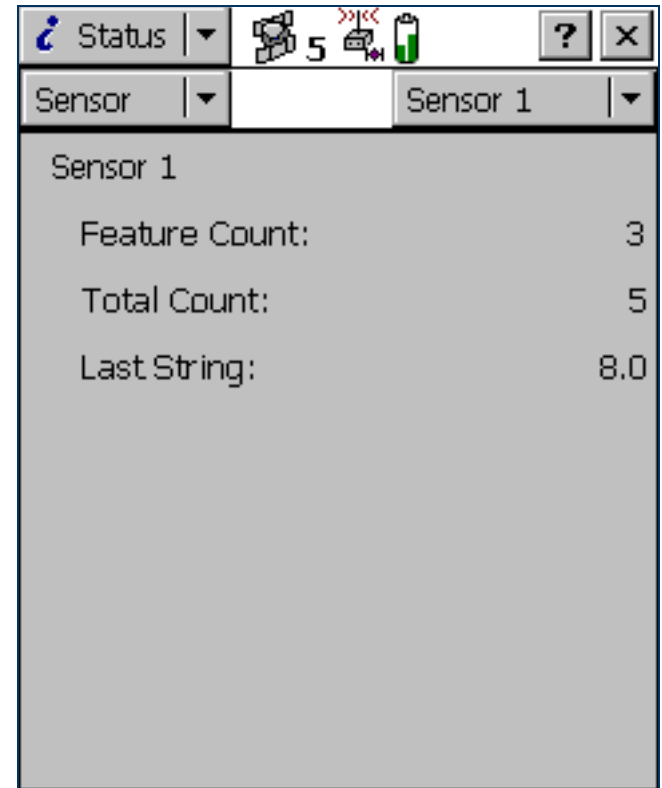

Sensor screen: Fields

Field	Description
<Sensor name>	The name of the sensor, as defined in the Sensor Properties form .
Feature Count	The number of messages received from the sensor since the start of the current feature. This field is only displayed if a feature is open.
Total Count	The total number of messages received from the sensor.
Last String	The last message string received from the sensor.

Comms

- **Fields**

To view communication port information, tap the Subsection list button and select Comms.

The Comms screen contains a field for each serial (COM) port that is available on the field computer. The value in each field is the name of the device that is connected to that port.

Comms screen: Fields

Value	Description
GPS	A GPS receiver is connected.
Laser	A laser rangefinder is connected.
<Sensor name>	An external sensor is connected.
Unknown Application	Another application is using the port.
None	No device is connected to the port.

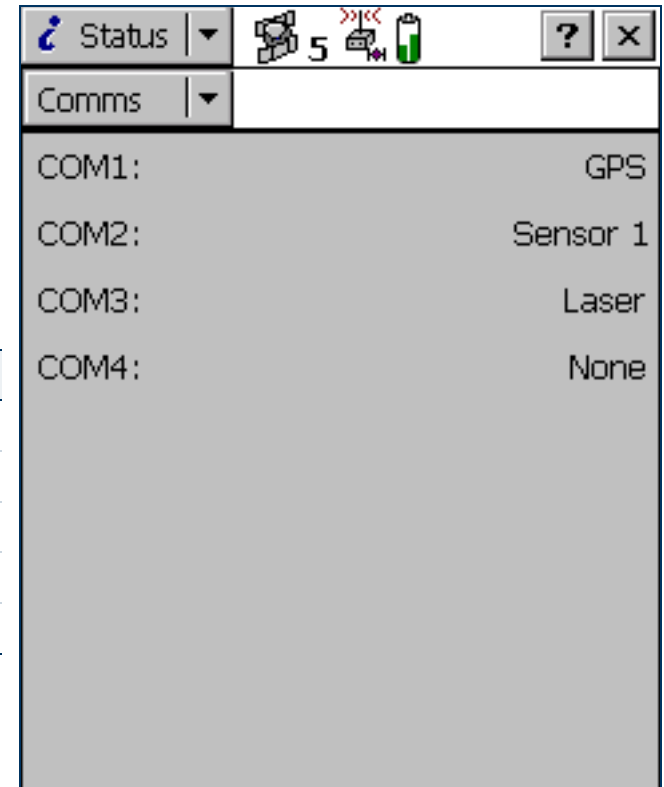

UTC Time

To display the UTC Time screen, tap the Subsection list button and select UTC Time. The UTC Time screen shows the current Universal Time Coordinated (**UTC**) time, calculated from the GPS time reported by the connected GPS receiver.

This screen is provided for use with the MediaMapper™ software. MediaMapper georeferences digital photographs to features collected in TerraSync or in other Trimble data collection software. To ensure that each photograph is georeferenced to the correct feature, you need to calibrate the digital camera's internal clock to UTC time. To do this, take a digital photograph of the UTC Time screen. MediaMapper compares the UTC time shown in the picture to the picture's time stamp, then calculates the offset between the camera's clock and UTC time.

To ensure an accurate calibration, it is important that the calibration photo displays the current UTC time. Whenever a GPS receiver is connected, TerraSync synchronizes its UTC time display every five seconds with the time reported by the GPS receiver. The UTC time is always up to date when TerraSync is connected to GPS.

If the receiver is disconnected, TerraSync uses the field computer's internal clock to update the UTC time display. However, the internal clock is not as accurate as the GPS time from the receiver, so the time displayed becomes less and less accurate. After 24 hours without synchronization (that is, without reconnecting to GPS), the UTC time displayed is no longer accurate enough to be used for calibration, so the UTC time display is replaced with the message **Time not available. Connect to GPS.**

NOTE — Before you take a calibration photograph, Trimble recommends that you connect to GPS and wait until the satellite icon with a number beside it  appears in the status bar.

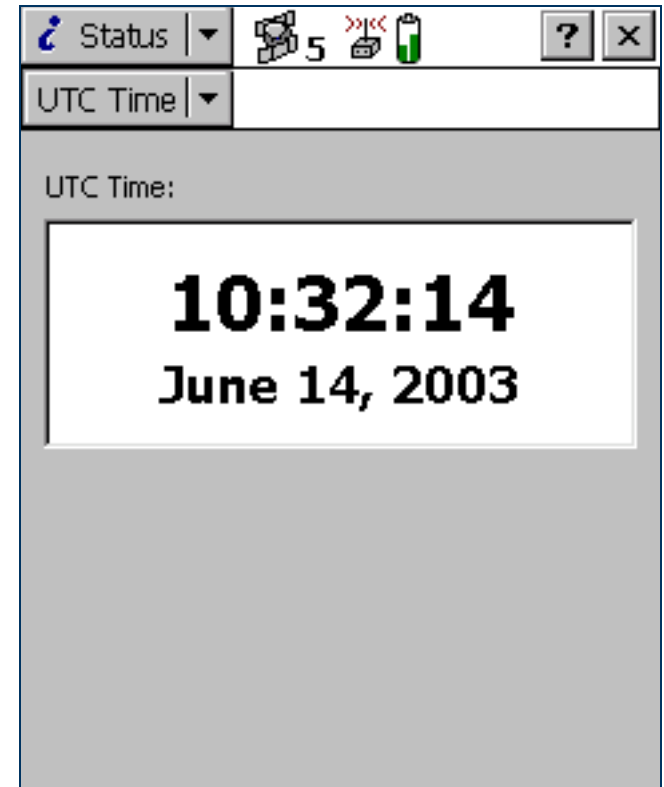

About

- **Fields**

To display the About screen, tap the Subsection list button and select About.

Use this screen to view information about the installed copy of the TerraSync software.

The About screen also contains the **System Report** button. It lets you create a text file describing the field computer's configuration. If you encounter a problem with the field computer or the TerraSync software, this file (Report.txt) may be requested by a technical support representative to assist with troubleshooting.

About screen: Fields

Field	Description
Version number	The version and edition of the TerraSync software that is installed.
Serial number	The serial number of this copy of the TerraSync software. This is the serial number you entered during installation.
Copyright	Copyright information.
Support Expiration Date	The date until which you are entitled to telephone support, e-mail support, and upgrades to later versions of the TerraSync software.
Acknowledgments	Acknowledgments for the parts of the TerraSync software that were developed by other companies.

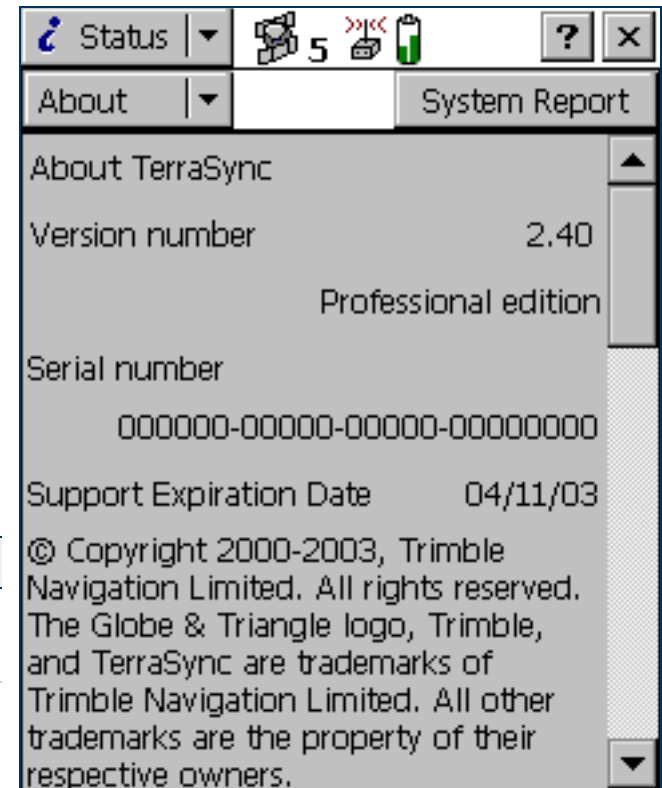

Setup section

- Buttons
- Fields
- Options

To open the Setup section, tap the Section list button and select Setup. The Setup screen appears.

Use the Setup section to configure the TerraSync software.

Use the Setup screen to perform common setup tasks, and to access the Setup section's six subsections:

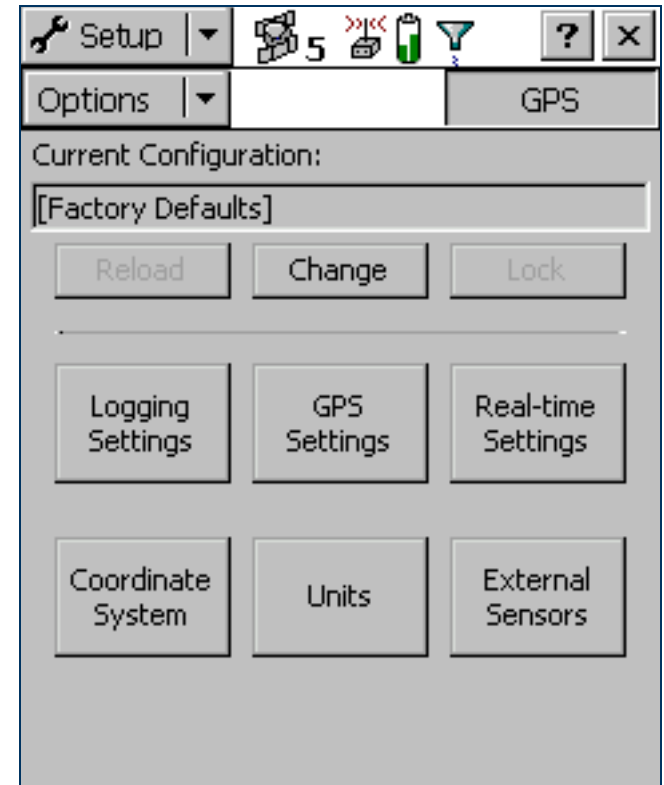

- Logging Settings
- GPS Settings
- Real-time Settings
- Coordinate System
- Units
- External Sensors



Setup screen: Buttons

Button	Description
Ext Source	Connects to or disconnects from an external VRS correction source. This button is a shortcut to the Connect to External Source and Disconnect from External Source options. This button only appears if you have configured a VRS External Source as the preferred real-time source, and TerraSync is connected to GPS.
GPS	Connects to or disconnects from the GPS receiver. This button is a shortcut to the Connect to GPS and Disconnect from GPS options.
Reload	Re-applies the settings from the selected configuration file. Any changes that you have made to the configuration will be lost.
Change	Opens the Choose Configuration form . Use this form to change to a different configuration file. If the current configuration file specifies that you cannot change configurations, this button is not available.
Lock	Locks the current configuration, or opens the Enter Password form . Use this form to unlock the current configuration. For more information, see Configuration files .
Logging Settings	Opens the Logging Settings form . If a base data file is open, this button is unavailable.
GPS Settings	Opens the GPS Settings form . If a base data file is open, this button is unavailable.
Real-time Settings	Opens the Real-time Settings form .
Coordinate System	Opens the Coordinate System form .
Units	Opens the Units form .
External Sensors	Opens the External Sensors form .

Setup screen: Fields

Field or icon	Description
Current Configuration	A read-only field that shows the name of the selected configuration file. If you have changed any settings since loading the configuration file, the text Based Upon is displayed in front of the filename. For more information, see Configuration files .
Lock icon	This icon indicates whether the loaded configuration file is locked () or unlocked ()

Setup screen: Options

Option	Description
Connect to GPS	Establishes a connection with the GPS receiver. If the GPS receiver is already connected, this option is not available.
Disconnect from GPS	Disconnects the TerraSync software from the GPS receiver. When you select this option, a message box appears, asking you to confirm that you want to disconnect from GPS. Tap Yes to disconnect. If the GPS receiver is already disconnected, this option is not available.
Reset GPS receiver	Resets the GPS receiver to its default settings. TIP – If the GPS receiver does not operate as expected after it has been connected to another field computer or another data collection application, reset the receiver. This clears any settings that may prevent it from working properly with the TerraSync software.
Activate Integrated Satellite	Lets you enter an activation code to enable your subscription to a satellite differential service. This option is only available if a satellite differential service has been set up as a real-time choice, and you are connected to a receiver that supports this service.
Connect to External Source	Establishes a connection with the configured VRS server. If TerraSync is already connected, this option is not available.
Disconnect from External Source	Disconnects the TerraSync software from the VRS server. If TerraSync is already disconnected, this option is not available.

Configuration files

A configuration file contains instructions that define, and optionally lock, the configuration of the TerraSync software. The configuration determines how data is collected, entered, and communicated with external devices. You can use configuration files to ensure that data collected by different field crews or on different days is collected in a consistent way.

To create a configuration file, use the Configuration Manager utility in the GPS Pathfinder Office software. You can specify a value for each setting, and you can specify whether each setting is password-locked. If a setting is password-locked, you cannot change it in TerraSync until you enter the correct password to unlock the configuration file.

In addition to configuring software settings, a configuration file can also be used to lock some tasks and options. You cannot use a locked option or perform a locked task until you unlock the configuration file.

A locked menu item or option appears grayed out, and has a locked icon (🔒) beside it. The same icon appears beside locked fields in the Setup section, which are read-only.

For more information on working with configuration files, see:

- [Reloading a configuration](#)
- [Resetting to factory defaults](#)

Changing configuration

Although you can send any number of configuration files to the TerraSync software, only one configuration can be loaded at a time. Provided the loaded configuration file has not locked changing configurations, you can load a different configuration file at any time. You do not have to close any open files or restart the software for the changes to take effect.

To load a different configuration file, tap **Change** in the main Setup screen, select a file in the **Choose Configuration form**, and tap **Load**.

If the **Change** button is not available, the current configuration file is locked and does not permit you to change configurations. You must unlock the current configuration file before you can load a different file, or edit password-locked settings. Tap **Unlock** and in the **Enter Password form** enter the configuration file's password. Once you have unlocked a configuration, you can edit all settings and access all menu items. You can leave the configuration unlocked, or tap **Lock** to lock it again.

If you have made changes to settings in the software, the name of the configuration file in the **Current Configuration** field is prefixed by **Based Upon**.

Reloading a configuration

Once you have changed settings from those defined in the selected configuration file, the configuration name in the main Setup screen's **Current Configuration** field is prefixed by **Based Upon**, and the **Reload** button becomes available.

You can reload a configuration at any time. Reloading returns all settings to the values defined in the selected configuration file. To reload a configuration, tap **Reload**. A message appears, asking you to confirm that you want to discard all changes to settings. Tap **Yes** to continue with reloading.

The Factory Defaults configuration is always available, even if you have not transferred any configuration files to the TerraSync software. Use the **Reload** button to reset the software to the factory default values.

Resetting to factory defaults

The Factory Defaults configuration file is always available. Provided the current configuration allows you to change configurations, you can reload the Factory Defaults configuration. This resets the software to the factory default settings.

The Factory Defaults configuration file is loaded in the same way as any other configuration file. For more information, see [Changing configuration](#) and [Reloading a configuration](#).

The factory default settings include:

- layer colors and any background file that is selected in the Map section
- filtering conditions and logging intervals in the Data section
- the default data dictionary for a new file (reset to Generic)
- options in the Navigation section
- all settings in the Setup section
- window size and pane layout, if the field computer displays [Panels](#)

Resetting does not delete data dictionaries, data files, or coordinate systems.

Choose Configuration form

- **Buttons**
- **Fields**

To open the Choose Configuration form, tap **Change** in the Setup screen.

To load a configuration from the list, highlight it and tap **Load**. The Choose Configuration form closes and the settings in the selected configuration file are applied.

TIP — The Factory Defaults configuration file is always available. Load it to reset the software to the factory default settings.

Choose Configuration form: Buttons

Button	Description
Load	Loads the settings in the selected configuration file.
Cancel	Returns to the Setup screen without changing the current configuration.

Choose Configuration form: Fields

Field	Description
List of files	A list of all of the configuration files loaded in TerraSync. To load a configuration file, select it from this list and then tap Load .

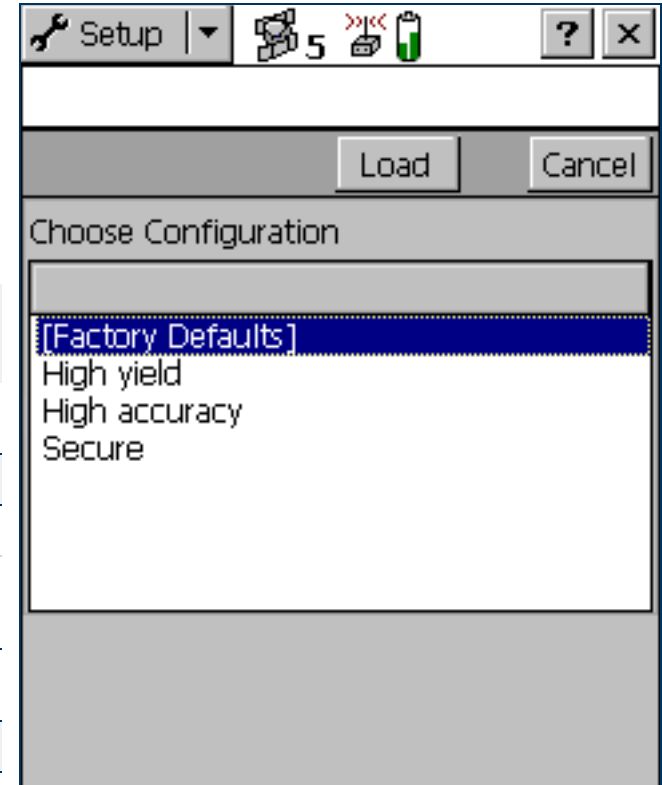

Enter Password form

- **Fields**

To open the Enter Password form, tap **Unlock** in the Setup screen. Use this form to unlock the current configuration file. Once you have entered the correct password, you can change settings and use options that are locked in this configuration.

NOTE — Passwords are case-sensitive.

If you have forgotten the password, see [You cannot unlock a configuration file](#).

Enter Password form: Fields

Field	Description
Enter Password	The password for the current locked configuration file.



Logging Settings

- **Fields**

To open the Logging Settings form, tap **Logging Settings** in the Setup screen. Use this form to configure settings that control what data is stored, and how.

Setup | [Signal] 5 [Battery] [Close]

Logging Settings [OK] [Cancel]

Log Velocity Data: [No]

Log SuperCorrect Data: [Yes]

Log QA/QC Data: [No]

Antenna Height: 2.000 m [Wrench]

Allow Position Update: [Confirm]

Confirm End Feature: [No]

Logging Settings form: Fields

Field	Description	Default
Log Velocity Data	<p>This field specifies whether to log velocity records as well as GPS position records. If you log velocity records, you can use velocity filtering in the GPS Pathfinder Office software to reduce any “spikes” in data that were caused by poor autonomous GPS conditions.</p> <p>TIP — If you log SuperCorrect records, you do not have to log velocity records as well.</p>	No
Log SuperCorrect Data	<p>This field specifies whether to log SuperCorrect records as well as GPS position records. If you log SuperCorrect records, you can use the SuperCorrect option in the GPS Pathfinder Office software to process the data using different GPS settings from those used in TerraSync, and you can use velocity filtering in GPS Pathfinder Office to reduce spikes in the data.</p>	Yes
Log QA/QC Data	<p>This field specifies whether to log any quality assurance/quality control (QA/QC) records that the GPS receiver generates. You can use QA/QC data to filter positions in the GPS Pathfinder Office software before you export the positions to a GIS. Some GPS receivers and versions of receiver firmware do not support logging of QA/QC records. If you have enabled QA/QC logging, then connect to a receiver that does not support this option, a message appears warning you that the current logging settings are not supported. If you open this form while connected to such a receiver, the only option in this field is No.</p>	No
Antenna Height	<p>The height of the GPS antenna. This field is read-only. To specify antenna details, tap the Setup button beside this field. The Antenna Settings form opens.</p>	0.00 m

Logging Settings form: Fields (Continued)

Field	Description	Default
Allow Position Update	<p>The conditions under which updating of feature position information is allowed. The options are:</p> <ul style="list-style-type: none"> • Yes Position information for existing features can always be updated. • No Positions cannot be updated. • Confirm Confirmation is required before you are allowed to update the position. 	Confirm
Confirm End Feature	<p>Select the Yes option to display a confirmation message when you close an updated feature. The message asks you to confirm that you want to end the current feature and save any changes to the feature's attributes or position information. Select the No option to disable the confirmation message.</p>	No
Filename Prefix	<p>The prefix to be included at the beginning of the default name of each new data file. The prefix may be any alphanumeric string between 1 and 30 characters long.</p> <p>NOTE – The prefix that you define in this field is for rover files only. The default filename prefix for base files is Base. You cannot change this default prefix. However, when you create a new base file, you can edit the default filename.</p>	R
Style	<p>The method of measurement for between feature positions. The options are:</p> <ul style="list-style-type: none"> • Time A position is logged after a specified time has elapsed since the last position logged. • Distance A position is logged once you have traveled a specified distance from the last position logged. 	Time

Logging Settings form: Fields (Continued)

Field	Description	Default
Interval	<p>The logging interval for the between feature positions:</p> <ul style="list-style-type: none"> • If you selected Distance from the Style list, enter the number of meters between logging positions, or select an existing value from the list. • If you selected Time from the Style list, enter the number of seconds between logging positions, or select an existing value from the list. • Select Off to turn off between feature logging. 	Off
Style	<p>The method of measurement for the specified feature type. The options are as for Style above.</p> <p>This field only appears if a data file is open. It is repeated for each feature type in the file.</p> <p>NOTE — If the feature is a point feature, this field is set to Time and cannot be changed.</p>	Time
Interval	<p>The logging interval for the specified feature type. The options are as for Interval above.</p> <p>This field only appears if a data file is open. It is repeated for each feature type in the file.</p>	Off
Accuracy	<p>This field specifies whether to log the usual code phase data from the GPS receiver, or to log more detailed but more accurate carrier phase data.</p> <p>This field only appears if a data file is open. It is repeated for each feature type in the file.</p>	Code

Antenna Settings form

- **Fields**

To open the Antenna Settings form, tap the Setup button beside the Antenna Height field on the **Logging Settings form**. Use this form to specify the antenna type you want to use, and the height of the antenna.

The screenshot shows the 'Antenna Settings' form on a handheld device. The title bar at the top contains a 'Setup' button with a dropdown arrow, and icons for signal strength (5 bars), battery level, and a close button. The form itself has a title bar with 'Antenna Settings', 'OK', and 'Cancel' buttons. The form contains the following fields:

- Height: 0.000 m
- Confirm: Per File
- Type: Zephyr
- Part Number: 39105-00
- Measure Height To: Bottom of antenna mount

Antenna Settings form: Fields

Field	Description	Default
Height	The height of the GPS antenna that is connected to the GPS receiver. This is used as a vertical offset on each position.	0.00 m
Confirm	<p>How often the software asks you to confirm the configured antenna height during data collection. The options are:</p> <ul style="list-style-type: none">• Never Do not confirm the antenna height before logging positions.• Per File Display the Confirm Antenna Height form whenever you open a new or existing data file.• Per Feature Display the Confirm Antenna Height form when you start a new feature, or when you update an existing feature's position information.	Per File
Type	<p>The type of antenna that is connected to the GPS receiver. If TerraSync is connected to a GPS Pathfinder Power, GPS Pathfinder Pocket, or 5800 receiver, or is running on a GeoExplorer CE series handheld, this field automatically shows the correct antenna type.</p> <p>To specify the antenna that you are using, either select an option from this field, or select the correct part number in the Part Number field. Whenever you change a value in one of these two fields, the other field updates accordingly.</p>	Unknown External

Antenna Settings form: Fields (Continued)

Field	Description	Default
Part Number	<p>The part number of the antenna that is connected to the GPS receiver. If TerraSync is connected to a GPS Pathfinder Power or Pocket receiver, or is running on a GeoExplorer CE series handheld, this field automatically shows the correct part number if applicable.</p> <p>To specify the antenna that you are using, either select an option from this field, or select the correct antenna type in the Type field. When you change a value in one of these two fields, the other field updates accordingly.</p>	n/a
Measure Height To	<p>The point on the antenna that you have measured to. For accurate altitude measurements, the antenna height must be measured to the electronic center of the antenna (its Antenna Phase Center, or APC). For some antenna types, the APC is not accessible. To accurately measure the antenna height, measure to another location, then select that location from this field. TerraSync automatically adjusts the antenna height by the distance between the measurement location and the APC.</p> <p>The options in this field vary depending on the selected antenna type. If the selected antenna type does not allow alternative measurement locations (for example, if you are using the internal antenna in a GeoExplorer CE series handheld), this field does not appear.</p>	(none)

GPS Settings

- **Fields**

To open the GPS Settings form, tap GPS Settings in the Setup screen. Alternatively, tap the Setup button  at the bottom of the **Skyplot screen**, or at the bottom of the **Satellite information screen**, in the **Status section**.

Use this form to control the precision you require for GPS positions, and to specify which port on the field computer the GPS receiver is connected to. There are two configuration modes: Slider and Custom. To change modes, select or clear the check box beside the GPS slider.

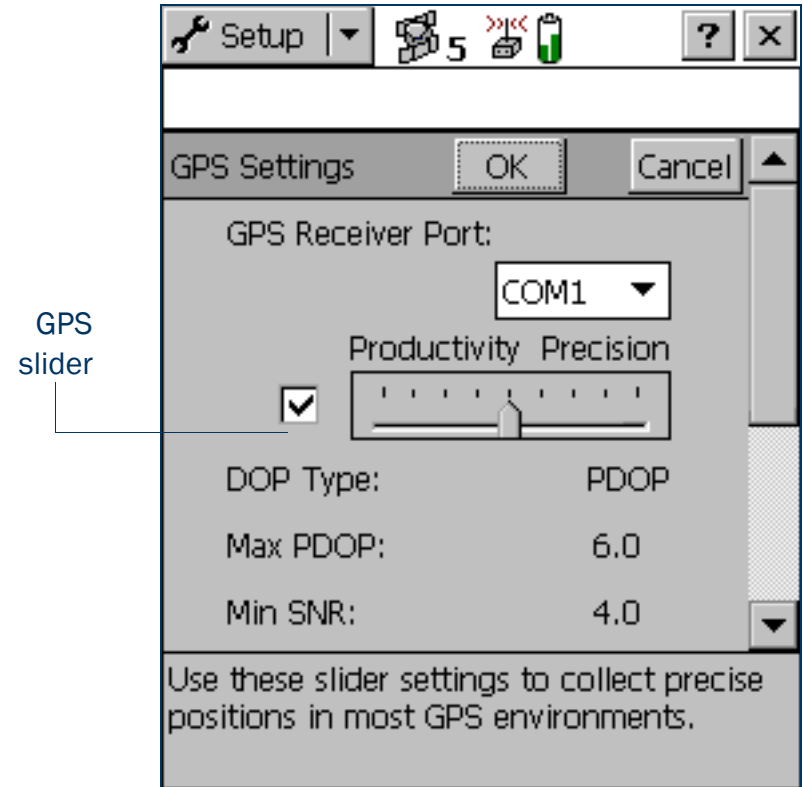

GPS Settings form: Fields

Field	Description	Default
GPS Receiver Port	The port on the field computer that the receiver is connected to.	COM1
Slider check box	<p>This field specifies whether the GPS settings are configured using Slider mode or Custom mode.</p> <p>To configure GPS settings in Slider mode, select the Slider check box. The slider control appears on the GPS slider, and the other fields in the form become read-only. The values in these fields change as the slider position changes.</p> <p>To configure GPS settings in Custom mode, clear the Slider check box. The slider control disappears from the GPS slider, and the remaining fields change to editable numeric fields. Enter values in these fields to specify the GPS settings you require.</p>	Selected
GPS slider	<p>The GPS slider makes it easy for you to change the level of accuracy without needing to know the best values for each precision setting.</p> <p>The GPS slider is a scale from Low to High. Drag the slider control to the <i>left</i> to decrease the GPS precision. Drag it to the <i>right</i> to increase the GPS precision and exclude positions that do not meet the precision requirements.</p> <p>TIP — The GPS slider is the same as the slider in the Setup area in the Skyplot and Satellite information screens. If you change the slider position in the GPS Settings form, it changes in the Setup areas.</p>	

GPS Settings form: Fields (Continued)

Field	Description	Default
DOP Type	<p>The type of maximum DOP value to use. The options are:</p> <ul style="list-style-type: none"> • PDOP Set a maximum PDOP. When you select this option, the Max PDOP field appears. • HDOP Set a maximum HDOP. When you select this option, the Max HDOP field appears. <p>A low DOP value indicates that the visible satellites are widely separated in the sky, which gives better position information. When the DOP value rises above the maximum value, the TerraSync software stops logging GPS positions. This field does not appear in Slider mode.</p>	PDOP
Max PDOP	<p>The maximum PDOP value. In Slider mode, this field is read-only, and its value is the maximum PDOP value for the current slider position.</p> <p>A low PDOP value indicates that the visible satellites are widely separated in the sky, which gives better position information. When the PDOP value rises above the maximum value, the GPS receiver stops logging GPS positions. Specify a lower maximum PDOP to collect fewer, more precise positions. Specify a higher maximum PDOP to collect more, less precise positions.</p>	6.0

GPS Settings form: Fields (Continued)

Field	Description	Default
Max HDOP	<p>The maximum HDOP value. Specifying a maximum HDOP can give greater productivity than filtering the solutions with a maximum PDOP. Setting a maximum PDOP rejects some positions that have an acceptable HDOP value, because their VDOP value is unacceptable. When you use a maximum HDOP, these positions are accepted.</p> <p>Use a maximum HDOP value when vertical precision is not particularly important, and productivity would be decreased by excluding positions with a high vertical component in the PDOP value (for example, if you are collecting data under canopy). This field does not appear in Slider mode. In Slider mode, you can only change the maximum PDOP. To set a maximum HDOP, use Custom mode.</p> <p>TIP — To achieve the same precision horizontally as you would achieve with a given maximum PDOP, set this value to two-thirds of the maximum PDOP.</p>	4.0
Min SNR	<p>The minimum SNR value. In Slider mode, this field is read-only, and its value is the minimum SNR value for the current slider position.</p> <p>The SNR is a measure of the quality of the signal from a satellite. When a satellite's SNR falls below the minimum value, the TerraSync software stops using that satellite to calculate your GPS position.</p>	4.0
Min Elevation	<p>The minimum elevation. In Slider mode, this field is read-only, and its value is the minimum elevation value for the current slider position.</p> <p>Signals from satellites that have a low elevation from the horizon can be of poor quality. The TerraSync software does not use any satellite that is below the minimum value to calculate your GPS position.</p> <p>NOTE — The minimum elevation that you specify in this field applies to code phase data only. To ensure that you collect high quality carrier phase data, the minimum elevation during carrier phase data collection is always 15°.</p>	15°

GPS Settings form: Fields (Continued)

Field	Description	Default
Velocity Filter	<p>This field specifies whether to apply velocity filtering to GPS positions. Velocity filtering reduces “spikes” in GPS data that are caused by poor GPS conditions. The options are:</p> <ul style="list-style-type: none"> • Auto Apply velocity filtering if either of the following is true: <ul style="list-style-type: none"> • The Log SuperCorrect Data option is enabled (all positions are filtered). • At least one valid real-time correction source is selected in the Choice fields, and the last Choice field is set to Wait for Real-time (only real-time positions are filtered). • Off Do not apply velocity filtering to any positions. <p>NOTE — Trimble recommends that you do <i>not</i> use velocity filtering in good GPS conditions.</p>	Off
NMEA Output	<p>Specifies whether the GPS receiver will output NMEA messages. Tap the Setup button beside this field to open the NMEA Output Settings form, where you can configure NMEA communication settings and the messages that will be generated.</p>	Off
RTK Precisions	<p>Summarizes the required precisions for RTK-corrected positions. When you log data using RTK corrections, each position generated has precision estimates associated with it. You can use these estimates to filter out positions that do not meet your accuracy requirements.</p> <p>The four values represent the horizontal and vertical precisions for static positions, and the horizontal and vertical precisions for roving positions.</p> <p>To change the configured precision values, tap the Setup button beside this field. The RTK Precision Settings form appears.</p>	5 cm, 5 cm, 10 cm, 15 cm

As you move the slider control left or right, the values in these fields change accordingly. The values associated with each slider value are as follows:

Position on slider bar	Max PDOP	Min SNR	Min Elevation
1 (Low – far left)	20.0	2.0	5°
2	12.0	2.5	10°
3	8.0	3.0	12°
4	7.0	3.5	14°
5	6.0	4.0	15°
6	5.5	4.5	15°
7	5.0	5.0	15°
8	4.5	5.5	15°
9 (High – far right)	4.0	6.0	15°

NOTE — The minimum elevation applies to code phase data only. To ensure that you collect high quality carrier phase data, the minimum elevation during carrier phase data collection is always 15°.

NMEA Output Settings form

- **Fields**

To open the NMEA Output Settings form, in the Real-time Settings screen tap the Setup button  beside the NMEA Output field.

Use this form to specify which NMEA messages the GPS receiver will generate, and the communication settings for the GPS receiver port that the messages are output on.

NOTE — The GeoExplorer CE series handheld does not output NMEA messages until you connect the virtual COM2 port (NMEA out) to the serial clip (COM1). To do this, use the GPS Connector utility.

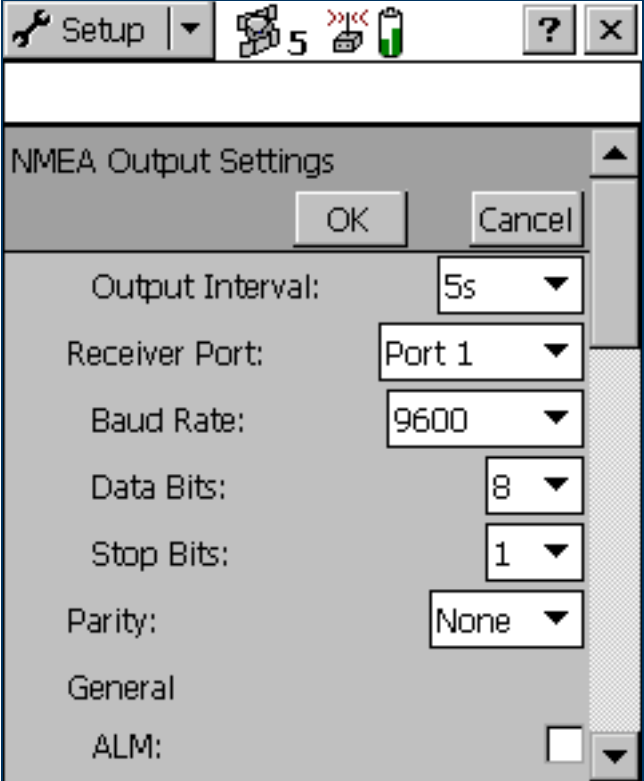

The screenshot shows the 'NMEA Output Settings' dialog box. At the top, there is a 'Setup' button with a wrench icon, a signal strength indicator showing '5', a battery level indicator, and a help icon. Below the title bar, there are 'OK' and 'Cancel' buttons. The settings are as follows:

Output Interval:	5s
Receiver Port:	Port 1
Baud Rate:	9600
Data Bits:	8
Stop Bits:	1
Parity:	None
General	
ALM:	<input type="checkbox"/>

NMEA Output Settings form: Fields

Field	Description	Default
Output Interval	The interval at which NMEA messages are output. The options are: <ul style="list-style-type: none">• Off• 1s• 5s	5s
Receiver Port	The port on the GPS receiver that NMEA messages are output on. This field only appears if the connected GPS receiver is a 5700 or 5800 receiver.	Port 1
Baud Rate	The baud rate that the GPS receiver and external device communicate at. The options are: <ul style="list-style-type: none">• 115K• 58K• 38K• 19K• 9600• 4800• 2400• 1200• 600• 300	9600
Data Bits	The number of data bits used when the GPS receiver and external device communicate. The options are: <ul style="list-style-type: none">• 7• 8	8

NMEA Output Settings form: Fields (Continued)

Field	Description	Default
Stop Bits	<p>The number of stop bits used when the GPS receiver and external device communicate.</p> <p>The options are:</p> <ul style="list-style-type: none"> • 1 • 2 	1
Parity	<p>The parity setting used when the GPS receiver and external device communicate.</p> <p>The options are:</p> <ul style="list-style-type: none"> • None • Odd • Even 	None
General	<p>Below this heading is a check box for each general NMEA message type. To output a message type, select the corresponding check box. The general message types that can be generated are:</p> <ul style="list-style-type: none"> • ALM • GGA • GLL • GSA • GSV • RMC • VTG • ZDA 	(none)

NMEA Output Settings form: Fields (Continued)

Field	Description	Default
Survey	<p>Below this heading is a check box for each NMEA message type that is used by 5700 and 5800 receivers. To output a message type, select the corresponding check box. The general message types that can be generated are:</p> <ul style="list-style-type: none">• AVR• GGK• GST• HDT• PJK• PJT• ROT• SYNC• VGK• VHD <p>These fields only appear if a 5700 or 5800 receiver is connected.</p>	(none)

RTK Precision Settings form

- **Fields**

To open the RTK Precision Settings form, in the Real-time Settings screen tap the Setup button  beside the RTK Precisions field.

Use this form to specify the minimum precision estimates for GPS positions corrected using RTK measurements. Positions that do not meet the specified precisions are not logged.

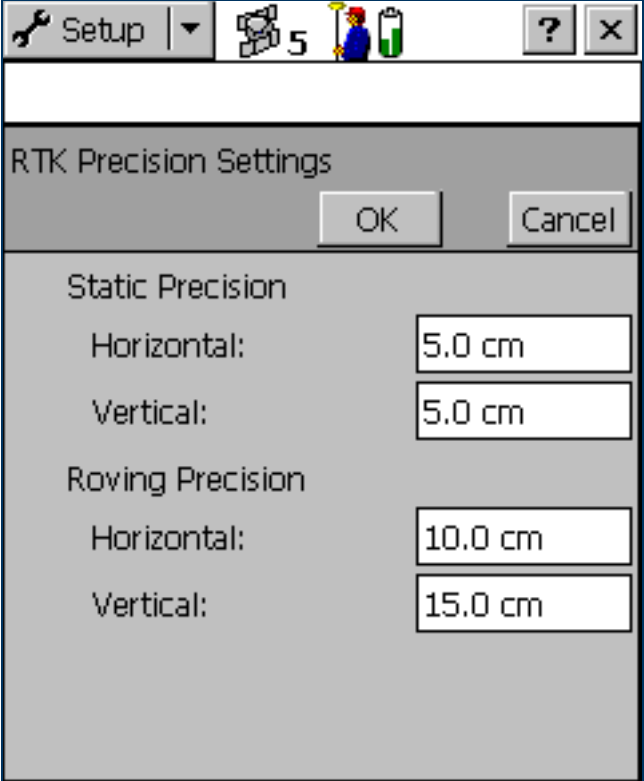

Section	Horizontal Precision	Vertical Precision
Static Precision	5.0 cm	5.0 cm
Roving Precision	10.0 cm	15.0 cm

RTK Precision Settings form: Fields

Field	Description	Default
Static Precision	Use the fields in this group to specify the required precision for positions in static mode. Static mode is used when collecting point features, or vertices for line or area features. In static mode, only the position with the best precision estimate is logged. All other positions are discarded.	(none)
Horizontal	The minimum horizontal precision for positions collected in static mode.	5.0 cm
Vertical	The minimum vertical precision for positions collected in static mode.	5.0 cm
Roving Precision	Use the fields in this group to specify the required precision for positions in roving mode. Roving mode is used when collecting line and area features. In roving mode, all positions that meet the required precision are logged.	(none)
Horizontal	The minimum horizontal precision for positions collected in roving mode.	10.0 cm
Vertical	The minimum vertical precision for positions collected in roving mode.	15.0 cm

Real-time Settings

- **Fields**

To open the Real-time Settings form, in the Setup screen tap **Real-time Settings**. Alternatively, tap the Setup button  at the bottom of any real-time status screen in the **Status section**.

Use this form to configure the **real-time differential GPS** sources that you use, if any, and to configure how the system communicates with each source.

If you set a Choice field to External Source, Integrated Beacon, Integrated Satellite, or Integrated RTK Radio, a Setup button  appears beside that field. Tap the Setup button to open the settings form for the selected source. Use the settings form to set configuration options that are specific to that choice:

- **External Source Settings form**
- **Integrated Beacon Settings form**
- **Integrated Satellite Settings form**
- **RTK Radio Settings form**

NOTE — No Setup button appears for the Use Uncorrected GPS, Wait for Real-time, or Integrated WAAS selections. There are no settings to configure for these selections.

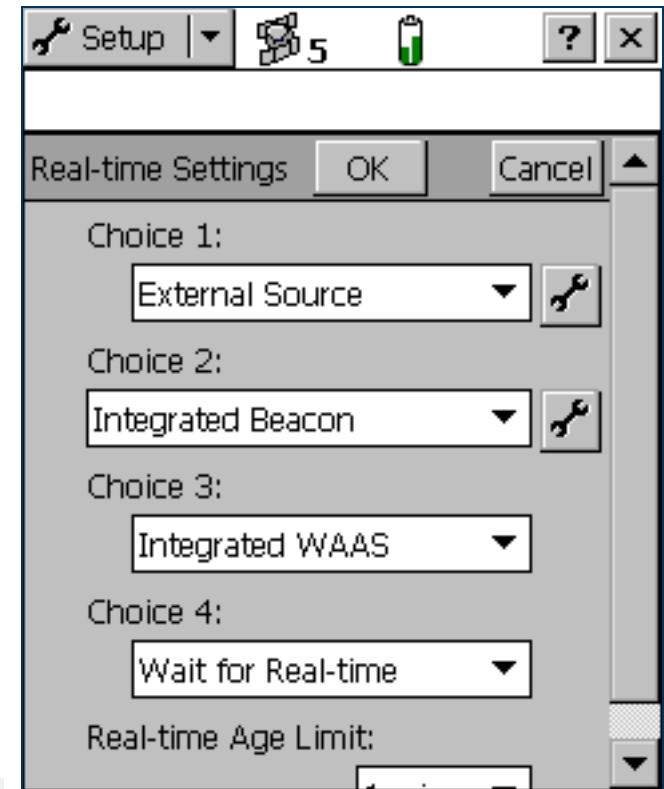

It is important that you set up all of the choices correctly, so that when the TerraSync software switches between choices it can continue to receive corrections.

NOTE — The Choice 2, Choice 3, and Choice 4 fields only appear if there are further options to choose from. For example, if you choose Use Uncorrected GPS in the Choice 1 field, there are no further valid choices, and the Choice 2, Choice 3, and Choice 4 fields do not appear.

The TerraSync software always uses the highest priority real-time source available, according to your list of preferences. If the source it is currently using becomes unavailable, TerraSync switches to the next choice. Whenever the TerraSync software acquires a higher priority real-time source, it switches back to this source. For example, TerraSync will not use your third choice if your first choice is available.

The Choice fields let you select up to four options for real-time corrections. However, there are restrictions on the correction combinations you can select. For example, External Source can only ever be selected in the Choice 1 field. Also, the last (least preferred) choice you make must be either Use Uncorrected GPS or Wait for Real-time. Once you select either of these options in a Choice field, there are no further logical choices you can make, so the subsequent Choice fields disappear.

NOTE — To record uncorrected GPS positions only, without using any real-time corrections, select Use Uncorrected GPS in the Choice 1 field. You can correct these positions back in the office using the GPS Pathfinder Office software, or you can correct them online using the GPS Pathfinder Express service.

Real-time Settings form: Fields

Field	Description	Default
Choice 1	<p>Your preferred source of real-time corrections. The options are:</p> <ul style="list-style-type: none"> • External Source Use an external correction source such as a virtual reference station (VRS), radio, or Beacon-on-a-Belt (BoB) receiver. • Integrated Beacon Use corrections from an integrated beacon receiver (Pro XR and Pro XRS receivers only). • Integrated Satellite Use corrections from an integrated satellite receiver (Pro XRS and Power receivers only). • Integrated WAAS Use corrections from the WAAS satellite differential service. If your location is between the longitudes of 30° West and 90° East, the GPS receiver tracks and uses EGNOS satellites instead of WAAS satellites. The following receivers support WAAS/EGNOS corrections: <ul style="list-style-type: none"> • GeoExplorer CE series handhelds (GPS firmware version 1.03 or later is required for EGNOS) • Pro XR, Pro XRS, and Power receivers with firmware version 1.50 or later (firmware version 1.70 or later is required for EGNOS) and the WAAS option enabled • Integrated RTK Radio Use RTK corrections from an integrated data radio in the GPS receiver (5700 and 5800 receivers only). To use RTK data with a 5800 receiver that does not have the optional internal radio, use the External Source option instead. • Use Uncorrected GPS Log autonomous GPS positions without applying real-time corrections. 	Integrated Beacon

Real-time Settings form: Fields (Continued)

Field	Description	Default
Choice 2	<p>The source of real-time corrections that you want to use when your first choice is not available. The options are as for the Choice 1 field except that External Source is not available, and the following additional option is available:</p> <ul style="list-style-type: none">• Wait for Real-time Suspend logging until a real-time correction source becomes available.	Use Uncorrected GPS
Choice 3	<p>What the TerraSync software should do when your first and second choices are not available. The options are:</p> <ul style="list-style-type: none">• Use Uncorrected GPS• Wait for Real-time• Integrated WAAS	(not displayed)
Choice 4	<p>What the TerraSync software should do when none of your other preferred real-time correction sources are available. The options are:</p> <ul style="list-style-type: none">• Use Uncorrected GPS• Wait for Real-time	(not displayed)

Real-time Settings form: Fields (Continued)

Field	Description	Default
Real-time Age Limit	<p>The maximum age at which a correction message will be used. A message's age is the time that has elapsed since it was received. The options are:</p> <ul style="list-style-type: none">• 15 seconds• 20 seconds• 25 seconds• 1 min• 2 min• 4 min <p>NOTE — If you are using a GPS Pathfinder Pro XL receiver, or a GPS Pathfinder Pro XR, Pro XRS, or Power receiver with an earlier firmware version than version 1.50 installed, the maximum age limit is 1 minute.</p>	50 seconds

The following table summarizes the valid combinations of real-time correction sources.

Real-time Settings form: Valid real-time correction choices

Choice 1	Choice 2	Choice 3	Choice 4	
External Source	Integrated Beacon	Integrated WAAS	Use Uncorrected GPS	
			Wait for Real-time	
		Use Uncorrected GPS	-	
		Wait for Real-time	-	
	Integrated Satellite	Integrated WAAS	Integrated WAAS	Use Uncorrected GPS
				Wait for Real-time
		Use Uncorrected GPS		-
				-
		Integrated WAAS	Use Uncorrected GPS	-
			Wait for Real-time	-
	Integrated Beacon	Integrated WAAS	Use Uncorrected GPS	-
			Wait for Real-time	-
		Use Uncorrected GPS		-
			Wait for Real-time	-
Integrated Satellite	Integrated WAAS	Use Uncorrected GPS	-	
		Wait for Real-time	-	
	Use Uncorrected GPS		-	
		Wait for Real-time	-	
Integrated WAAS	Use Uncorrected GPS	-		
	Wait for Real-time	-		
Integrated RTK Radio	Wait for Real-time	-		
Use Uncorrected GPS	-	-		

You do not have to remember which combinations are valid; the TerraSync software manages this for you by hiding invalid options or Choice fields depending on your previous choices. For example, with a GPS Pathfinder Pro XRS receiver, you cannot use Integrated Satellite if you have already selected Integrated Beacon for a higher choice. When you select Integrated Beacon in the Choice 2 field, Integrated Satellite is removed from the options for the Choice 3 field.

The software also ensures that you do not select choices that are not valid for the connected GPS receiver. For example, if the connected receiver is a GeoExplorer CE series handheld, only the External Source, Integrated WAAS, and Use Uncorrected GPS options are available in the Choice 1 field. If you then select Integrated WAAS in the Choice 1 field, the only options available in the Choice 2 field are Use Uncorrected GPS and Wait for Real-time. If you have configured an invalid real-time combination before connecting the GPS receiver, a warning message appears when you connect to GPS, telling you to check your real-time settings. When you open the Real-time Settings form, the only changes you can make to your real-time settings are those that are compatible with the connected receiver.

External Source Settings form

- **Fields**

To open the External Source Settings form, in the Real-time Settings form select External Source in the Choice 1 field. Then tap the Setup button  beside the Choice 1 field.

Use this form to configure settings specific to an external real-time source, such as a virtual reference station (VRS).

For more information on connecting to a VRS, see [Using corrections from a VRS](#).

TIP — You cannot use the settings in this form to change settings on the Beacon-on-a-Belt (BoB) receiver. To change BoB receiver settings, use the PC-BoB software that is supplied with the receiver.

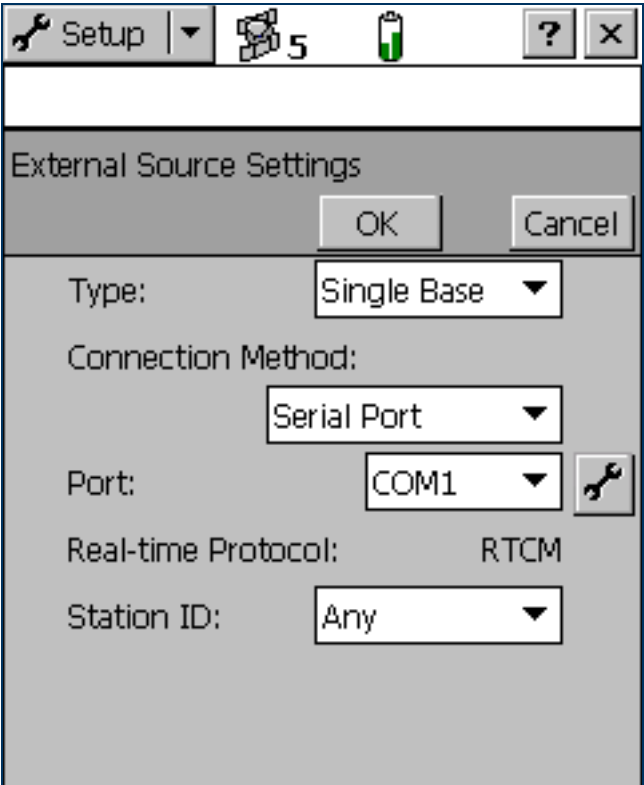

External Source Settings

OK Cancel

Type: Single Base ▼

Connection Method: Serial Port ▼

Port: COM1 ▼ 

Real-time Protocol: RTCM

Station ID: Any ▼

External Source Settings form: Fields

Field	Description	Default
Type	<p>The type of source. The options are:</p> <ul style="list-style-type: none"> • Single Base Corrections are sent by a single base station. • VRS Corrections are sent by a virtual reference station (VRS) server, which uses corrections from several base stations to compute corrections for a virtual base station at your location. 	Single Base
Connection Method	<p>How TerraSync connects to the external correction source. The options are:</p> <ul style="list-style-type: none"> • Internet TerraSync communicates with a VRS server over a TCP/IP connection, for example using a GSM or GPRS cellphone. The connection must be configured and made outside TerraSync. • Direct Dial TerraSync communicates with a VRS server using a dial-up modem connection. • Serial Port RTCM corrections are received by a data radio, such as a BoB receiver or TRIMTALK™ radio, connected to a serial port on the field computer. • Receiver Port Corrections are received by a data radio that is connected to the GPS receiver. This option is only available if the Type field is set to Single Base. To configure communication settings for the port, tap the Setup button  beside this field. The Receiver Port Settings form appears. 	Serial Port

External Source Settings form: Fields (Continued)

Field	Description	Default
Address	<p>The IP address (for example, 255.255.255.255) or URL (for example, vrs.seaview.gov) of the VRS server or broadcast server that is supplying the VRS corrections. A broadcast server manages authentication and password control for a network of VRS servers, and relays VRS corrections from the selected VRS server to TerraSync.</p> <p>This field only appears if the Connection Method field is set to Internet.</p>	(blank)
Port	<p>When the Connection Method field is set to Serial Port, this field specifies the serial (COM) port on the field computer that the external correction source is connected to.</p> <p>When the Connection Method field is set to Internet, this field specifies the port on the VRS server to connect to.</p> <p>Tap the Setup button  beside the Port field to open the Serial Port Settings form, where you can configure the serial port settings.</p> <p>This field only appears if the Connection Method field is set to Serial Port or Internet.</p>	COM1 (Serial Port) or 80 (Internet)
Modem Type	<p>The type of modem you are using to connect to the VRS server.</p> <p>This field only appears if the Connection Method field is set to Direct Dial.</p>	(blank)
Phone Number	<p>The VRS server's telephone number.</p> <p>This field only appears if the Connection Method field is set to Direct Dial.</p>	(blank)

External Source Settings form: Fields (Continued)

Field	Description	Default
Source	<p>If you are connecting to a VRS server through a broadcast server, this read-only field shows the selected VRS server. If you are connecting directly to a VRS server, or have not yet selected a VRS server, this field shows the text Not Applicable. To select a VRS server, tap the Setup button  beside the Source field. TerraSync attempts to establish a connection to the broadcast server. If the connection is successful, the Select Server form appears. Select the VRS server that you want to use and tap OK to return to the External Source Settings form. This field only appears if the Connection Method field is set to Internet.</p>	Not Applicable
User name	<p>The username that you use to log on to the broadcast server. This field only appears if the VRS server you want to use requires authentication.</p>	(blank)
Password	<p>The password that you use to log on to the broadcast server. This field only appears if the VRS server you want to use requires authentication.</p>	(blank)
Connection Control	<p>This field specifies whether communication with the server is controlled automatically by TerraSync, or is controlled manually. The options are:</p> <ul style="list-style-type: none"> • Auto TerraSync automatically establishes a connection when it is needed, and re-connects if an existing connection is lost. • Manual You must manually connect to the VRS server whenever you want to use real-time VRS corrections. To connect or disconnect, tap the Ext Source button in the main screen of the Setup section. <p>This field only appears if the Connection Method field is set to Internet or Direct Dial.</p>	Auto

External Source Settings form: Fields (Continued)

Field	Description	Default
Real-time Protocol	The type of real-time correction messages that the external source is transmitting. Currently only RTCM messages are supported, so this field displays RTCM, and is read-only.	RTCM
Station ID	The reference station that you want to use real-time corrections from. Select Any to use any available station, or enter a station ID number between 0 and 1023. This field is only displayed if the Type field is set to Single Base.	Any
Receiver Power Output	<p>This field specifies whether the connected receiver outputs power. If the connected GPS receiver can be configured to supply power, you can use this field to enable power output for an external device such as a DGPS radio. The options are:</p> <ul style="list-style-type: none"> • Auto Corresponds to the On option for a GPS Pathfinder Power, 5700, or 5800 receiver; corresponds to Off for all others. • On Enable power output. • Off Disable power output. <p>WARNING — Enabling power output can damage some field computers. Trimble recommends that you always select the Auto option unless you require power to another external device <i>and</i> have protected the field computer from power that is supplied by the GPS receiver.</p> <p>This field only appears if the Connection Method field is set to Receiver Port. For more information, see Receiver power output.</p>	Auto

Receiver power output

Trimble 5700 and 5800 receivers, and some GPS Pathfinder receivers, can output power on their serial ports. This can be useful if you want to supply power to an external device, such as an external radio for real-time differential corrections. However, some field computers cannot accept power supplied on a serial port by a GPS receiver. Supplying power can cause problems with, or even permanent damage to, the field computer.

If you enable power output, power is supplied to all of the GPS receiver's ports. When you select the Auto or On option in the **Receiver Power Output** field, TerraSync displays a warning message to remind you that power will be supplied to the field computer and to the external device.

If you want to supply power from the GPS receiver to an external device, you must:

- check that the GPS receiver is capable of power output on its serial ports (see the table below).
- enable power output in the **Serial Port Settings form**.
- connect the device to the GPS receiver using a *non-powered* connection. Either use the curly straight-through cable PN 45052, or connect a null modem adaptor (PN 43197) to a powered cable.
- connect the external device to the GPS receiver using a *powered* connection such as the curly straight-through cable PN 30236.

The following table shows the GPS receivers that are supported by TerraSync and indicates their power output behavior:

GPS receiver	Outputs power	Auto option corresponds to	Comments
GPS Pathfinder Power 5700 5800	Always	On	Power output cannot be disabled, even if you select the Off option. <i>Always</i> protect the field computer using the data/power cable with PN 45052, or a null modem adaptor.
GPS Pathfinder Pro XRS GPS Pathfinder Pro XR GPS Pathfinder Pro XL	Configurable	Off	If power output is required, select On and protect the field computer using the data/power cable with PN 45052, or a null modem adaptor.
GPS Pathfinder Pocket GeoExplorer CE series handheld (GeoXT or GeoXM)	Never	Off	These GPS receivers do not output power. When one of these receivers is connected, you cannot select the On option.

Receiver Port Settings form

- **Fields**

To open the Receiver Port Settings form, in the **External Source Settings form** tap the Setup button  beside the Connection Method field.

Use this form to configure communication settings when an external correction source is connected to a port on the receiver.

This form is also used to configure communication settings when you choose to output corrections while collecting base station data. In this case, access the form from the **Base Station Setup wizard** in the Data section.

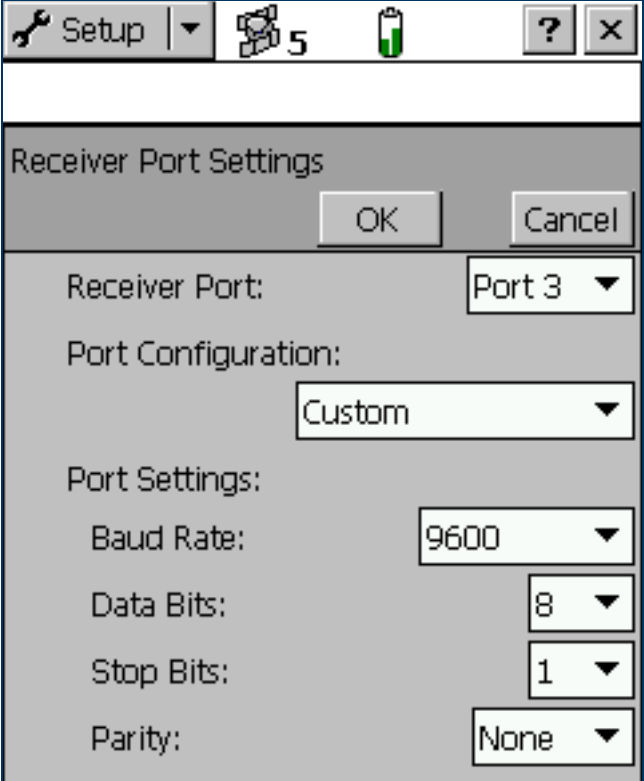

Receiver Port Settings

OK Cancel

Receiver Port: Port 3

Port Configuration: Custom

Port Settings:

Baud Rate: 9600

Data Bits: 8

Stop Bits: 1

Parity: None

Receiver Port Settings form: Fields

Field	Description	Default
Receiver Port	The port on the GPS receiver that the external device is connected to. On a 5700 receiver, external devices can only be connected to Port 3. When a 5700 receiver is connected, the only option available for this field is Port 3.	Port 3 (5700) or Port 1 (other receivers)
Port Configuration	The communication settings for the port. There is an option for each communications protocol (NMEA, RTCM, and TSIP), and an option for each type of radio supported. These options define preset values that match the radio's <i>default</i> settings. The values defined for each option appear in this form in read-only fields. If the external device allows you to configure port settings, the preset values may not match the device's current settings. If this is the case, or if the device you want to use is not listed, select the Custom option. The remaining fields become available and you can select customized port settings.	Custom

Receiver Port Settings form: Fields (Continued)

Field	Description	Default
Baud Rate	<p>The baud rate the GPS receiver and external source communicate at. The options are:</p> <ul style="list-style-type: none">• 115K• 58K• 38K• 19K• 9600• 4800• 2400• 1200• 600• 300 <p>This field is read-only unless you select Custom in the Type field.</p>	9600
Data Bits	<p>The number of data bits used when the external correction source and GPS receiver communicate. The options are:</p> <ul style="list-style-type: none">• 7• 8 <p>This field is read-only unless you select Custom in the Type field.</p>	8

Receiver Port Settings form: Fields (Continued)

Field	Description	Default
Stop Bits	<p>The number of stop bits used when the external correction source and GPS receiver communicate. The options are:</p> <ul style="list-style-type: none">• 1• 2 <p>This field is read-only unless you select Custom in the Type field.</p>	1
Parity	<p>The parity setting used when the GPS receiver and external source communicate. The options are:</p> <ul style="list-style-type: none">• None• Odd• Even <p>This field is read-only unless you select Custom in the Type field.</p>	None

Serial Port Settings form

- Fields

To open the Serial Port Settings form, in the **External Source Settings form** tap the Setup button  beside the Port field.

Use this form to configure communication settings when an external correction source is connected to an external COM port.

NOTE — When an application opens the serial port, it controls that port. You cannot access the port or change its settings from another application until the port is closed again. Settings that you define in this form are only applied if the port is not in use by another application.

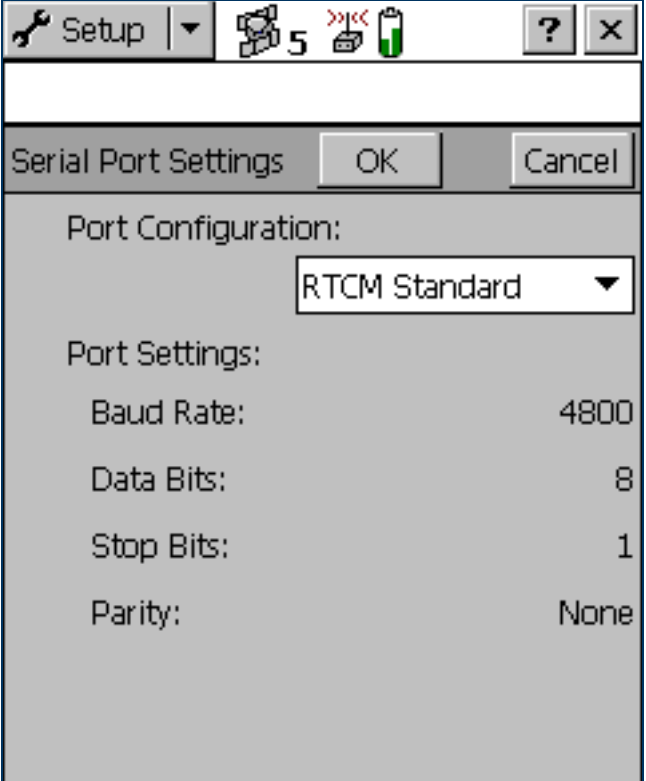

Serial Port Settings

Port Configuration:
RTCM Standard

Port Settings:

Baud Rate:	4800
Data Bits:	8
Stop Bits:	1
Parity:	None

Serial Port Settings form: Fields

Field	Description	Default
Port Configuration	<p>The communication settings for the port. There is an option for each communications protocol (NMEA, RTCM, and TSIP), and an option for each type of radio supported. These options define preset values which match the radio's <i>default</i> settings. The values defined for each option appear in this form in read-only fields.</p> <p>If the external device allows you to configure port settings, the preset values may not match the device's current settings. If this is the case, or if the device you want to use is not listed, select the Custom option. The remaining fields become available and you can select customized port settings.</p>	Custom
Baud Rate	<p>The baud rate the GPS receiver and external source communicate at. The options are:</p> <ul style="list-style-type: none">• 115K• 58K• 38K• 19K• 9600• 4800• 2400• 1200• 600• 300 <p>This field is read-only unless you select Custom in the Type field.</p>	9600

Serial Port Settings form: Fields (Continued)

Field	Description	Default
Data Bits	<p>The number of data bits used when the external correction source and GPS receiver communicate. The options are:</p> <ul style="list-style-type: none">• 7• 8 <p>This field is read-only unless you select Custom in the Type field.</p>	8
Stop Bits	<p>The number of stop bits used when the external correction source and GPS receiver communicate. The options are:</p> <ul style="list-style-type: none">• 1• 2 <p>This field is read-only unless you select Custom in the Type field.</p>	1
Parity	<p>The parity setting used when the GPS receiver and external source communicate. The options are:</p> <ul style="list-style-type: none">• None• Odd• Even <p>This field is read-only unless you select Custom in the Type field.</p>	None

Select Server form

- **Fields**

To open the Select Server form, do one of the following in the **External Source Settings form**:

- tap the Setup button  beside the Source field
- change the value in the Address field or the Port field, and then move to another field.

If the specified Internet address is a VRS **broadcast server**, the Select Server form appears, listing the VRS servers that are available through the selected broadcast server. Use this form to select the VRS server that you want to receive corrections from.

TIP — If you cannot find a server on the list, return to the External Source Settings form and make sure that the option that you require (VRS or Single Base) is selected in the Type field.

The form contains a table of information about the available VRS servers. You can drag each column heading to resize the column, or tap a column heading to sort by that column. If the list is already sorted by the column you tap, the sort order is reversed.

To select a VRS server, highlight it in the list and then tap **OK**. You are returned to the External Source Settings form, where the selected server name is displayed in the Source field.

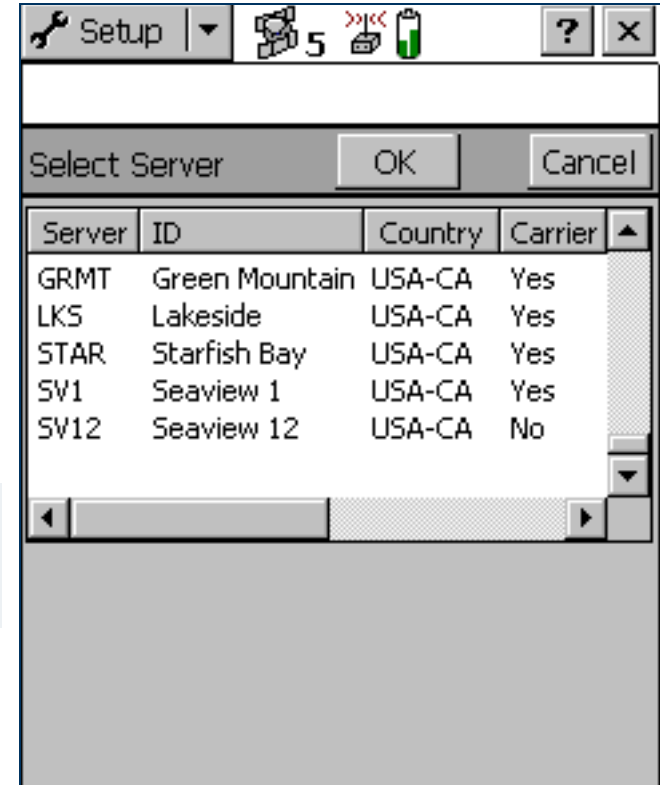

Select Server form: Fields

Field	Description
Server	The identification code of the VRS server.
Name	A description of the VRS server.
Country	The three-letter code for the country where the VRS server is located.
Carrier	This field specifies whether the VRS data stream includes carrier phase data.
Format	The format of the data stream, such as RTCM, raw data, or CMR. NOTE — Currently, TerraSync does not support VRS data in CMR format.
Details	Details of the message format, such as the RTCM message types generated.
Network	The network or VRS service provider.
Generator	The hardware or software used to generate the data stream.
Solution	This field specifies whether the data stream is generated from a single base station (Single Base) or a network of base stations (Network Solution).
Fee	This field specifies whether there is a charge for use of the correction data.
Rate	The bit rate of the data stream, in bits per second.
Misc	Miscellaneous notes about the VRS server.

Integrated Beacon Settings form

- **Fields**

To open the Integrated Beacon Settings form, in the Real-time Settings form select Integrated Beacon from a Choice field. Then tap the Setup button  beside the Choice field.

Use this form to configure settings that are specific to an integrated beacon real-time source.

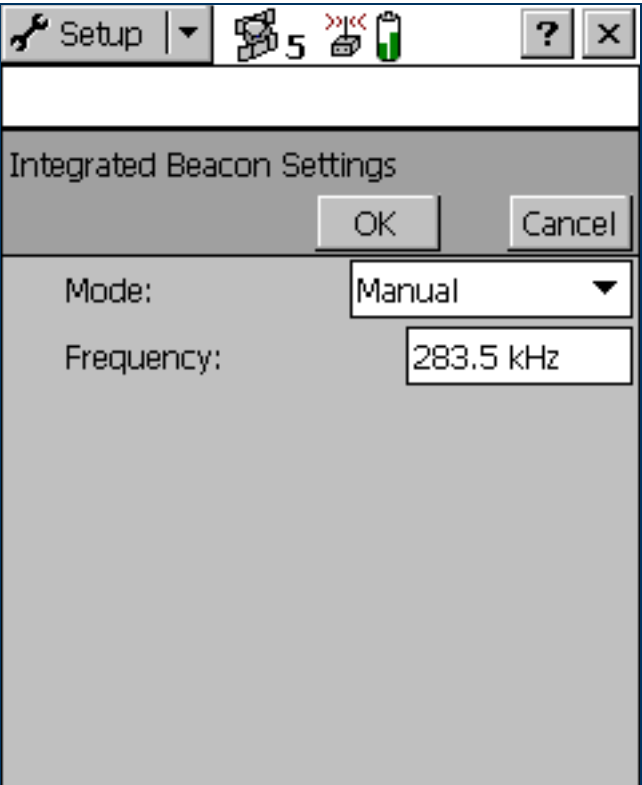

Setup | ▾

5 >><< 🔋

?

X

Integrated Beacon Settings

OK Cancel

Mode: Manual ▾

Frequency: 283.5 kHz

Integrated Beacon Settings form: Fields

Field	Description	Default
Mode	<p>The radiobeacon signal tracking mode to operate the integrated beacon in. The options are:</p> <ul style="list-style-type: none">• Auto Power The receiver tracks and locks on to the most powerful radiobeacon signal.• Auto Range The receiver tracks and locks on to the nearest radiobeacon signal.• Manual The receiver tracks only the frequency you specify in the Frequency field.	Auto Range
Frequency	The frequency used when you select Manual in the Mode field.	283.5 kHz

Integrated Satellite Settings form

- **Fields**

To open the Integrated Satellite Settings form, in the Real-time Settings form select Integrated Satellite from a Choice field. Then tap the Setup button  beside the Choice field.

Use this form to configure settings that are specific to an integrated satellite real-time source.

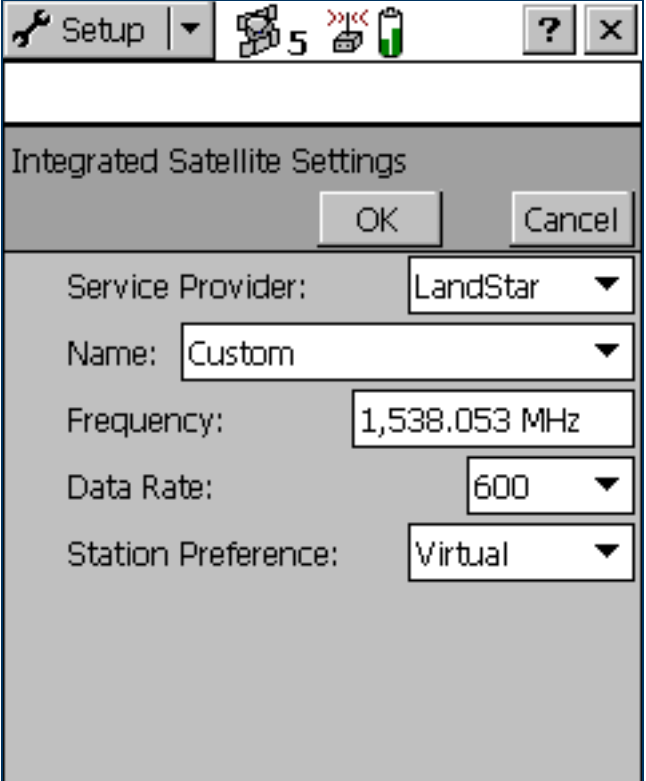

Setup | [Signal] 5 [Red X] [Battery]

Integrated Satellite Settings

OK Cancel

Service Provider: LandStar ▼

Name: Custom ▼

Frequency: 1,538.053 MHz

Data Rate: 600 ▼

Station Preference: Virtual ▼

Integrated Satellite Settings form: Fields

Field	Description	Default
Service Provider	The satellite differential service provider. The options are: <ul style="list-style-type: none"> • OmniSTAR • LandStar • (blank) 	(blank)
Name	The satellite used for satellite differential corrections. The options in this list depend on the satellite differential service provider that is selected.	Custom
Frequency	The frequency used when you select Custom in the Name field.	1538.053 MHz
Data Rate	The data rate used when you select Custom in the Name field. The options are: <ul style="list-style-type: none"> • 600 • 1200 • 2400 • 4800 	
Station Preference	Your preferred reference station type when you select Custom in the Name field and LandStar in the Service Provider field. The options are: <ul style="list-style-type: none"> • Virtual A position that is calculated from the center of the reference station network. This provides a reference position based on the approximate position of the roving receiver. • Closest The nearest reference station position. This may be an actual reference station, a calculated reference position (a “cell”), or the center of the reference station network. 	Virtual

RTK Radio Settings form

- **Fields**

To open the RTK Radio Settings form, in the Real-time Settings form select Integrated RTK Radio from a Choice field. Then tap the Setup button  beside the Choice field.

Use this form to configure communication settings between the integrated RTK data radio of a 5700 or 5800 receiver, and a data radio that is transmitting RTK corrections from a base station.

TIP — To receive RTK corrections on a 5700 or 5800 receiver that does not have an internal RTK radio, connect the receiver to an external radio instead. Use the **External Source Settings form** to configure communication between the external data radio and the receiver.



The screenshot shows the RTK Radio Settings form. At the top, there is a title bar with a 'Setup' button and a dropdown arrow, and icons for signal strength (5), RTK status, and battery. Below the title bar are 'OK' and 'Cancel' buttons. The main content area has two dropdown menus: 'Channel:' with the value '1 - 466.726 kHz' and 'Base Type:' with the value 'TrimTalk450s 4800'.

RTK Radio Settings form: Fields

Field	Description	Default
Channel	The channel that the integrated RTK radio is receiving RTK messages on. If a receiver with an integrated RTK radio is connected, this field lists the radio's channels and their frequencies. If no receiver is connected, the frequencies are listed as Unknown.	1 - Unknown
Base Type	The type of RTK radio and the wireless rate that the base station is using. The options are: <ul style="list-style-type: none">• TRIMTALK 450S 4800• TRIMTALK 450S 9600• TRIMMARK II 4800	TRIMTALK 450S 4800

Coordinate System

- **Fields**

To open the Coordinate System form, in the Setup screen tap **Coordinate System**.

Use this form to specify the coordinate system that you want the TerraSync software to use to display foreground and background files.

NOTE — Data files are stored using the current coordinate system. If you change coordinate system, the current data file's coordinates are recalculated, which may take some time.

NOTE — A background image is referenced to a particular coordinate system and can only be opened in that coordinate system. If you change coordinate system, any open background image is unloaded.

The screenshot shows a mobile application interface for setting the coordinate system. At the top, there is a status bar with a 'Setup' dropdown, a camera icon, the number '5', a battery icon, and a signal strength icon. Below the status bar is a title bar with 'Coordinate System', 'OK', and 'Cancel' buttons. The main form area contains the following fields:

- Select By:** A dropdown menu set to 'Coordinate System and Zone'.
- System:** A dropdown menu set to 'UTM'.
- Zone:** A dropdown menu set to '1 North'.
- Datum:** A dropdown menu set to 'WGS 1984'.
- Altitude Reference:** A dropdown menu set to 'Height Above Ellipsoid (HAE)'.

Coordinate System form: Fields

Field	Description	Default
Select By	<p>How the coordinate system is selected. By default this field is read-only. If you have transferred sites to the TerraSync software, the options are:</p> <ul style="list-style-type: none"> • Coordinate system and zone A coordinate system and a zone within that system. • Site A named site. Each site is associated with a coordinate system and zone that you cannot change. 	Coordinate system and zone
Site	<p>If you selected Site in the Select By field, this field shows the site name. This field does not appear if you have not transferred sites to the TerraSync software.</p>	(none)
System	<p>The coordinate system to be used in the TerraSync software. If you selected Site in the Select By field, this field is read-only.</p>	Latitude/ Longitude
Zone	<p>The zone in the coordinate system. This field does not appear if the selected coordinate system does not have zones. If you selected Site in the Select By field, this field appears but is read-only.</p>	(none)
Datum	<p>The datum that the selected coordinate system and zone are associated with. If the system can be associated with only one datum, this field is read-only.</p>	WGS 1984
Altitude Reference	<p>This field specifies whether to display height values relative to the geoid (mean sea level, or MSL) or relative to the ellipsoid (height above ellipsoid, or HAE).</p>	Height Above Ellipsoid (HAE)

Coordinate System form: Fields (Continued)

Field	Description	Default
Coordinate Units	<p>Select the unit of measurement to be used for coordinate values. Options in the drop-down list are:</p> <ul style="list-style-type: none">• Meters• Feet• Inches• Yards• Kilometers• Miles• Nautical Miles• US Survey Feet• Millimeters• Namibian Meters• Chains• Links• Centimeters <p>NOTE — This setting is for Northing and Easting distances only. Units for direct measures of distance are controlled by the Distance Units field on the Units form.</p>	(none)

Coordinate System form: Fields (Continued)

Field	Description	Default
Altitude Units	The unit of measurement to be used for altitude values. Options in the drop-down list are as for the Coordinate Units field.	Meters
Display USNG	<p>The level of precision for northing and easting values when displaying U.S. National Grid (USNG) coordinates. The options are:</p> <ul style="list-style-type: none">• Off Disable the display of USNG values, and display coordinates to 2 decimal places• 10,000 m Display USNG coordinates to 2 digits• 1,000 m Display USNG coordinates to 4 digits• 100 m Display USNG coordinates to 6 digits• 10 m Display USNG coordinates to 8 digits• 1 m Display USNG coordinates to 10 digits	Off

Units

- **Fields**

To open the Units form, in the Setup screen tap **Units**.

Use this form to specify the units used for measurements and display.

The screenshot shows a mobile application interface for setting units. At the top, there is a 'Setup' menu with a wrench icon, a signal strength indicator showing '5', a battery icon, and a close button. Below this is a dialog box titled 'Units' with 'OK' and 'Cancel' buttons. The dialog contains five sections, each with a label and a dropdown menu:

- Distance Units:** Meters
- Area Units:** Square Meters
- Velocity Units:** Kilometers per Hour
- Angle Units:** Degrees
- Lat/Long Format:** DD°MM'SS.ss"

Units form: Fields

Field	Description	Default
Distance Units	<p>The unit that distances are measured and displayed in. Options in the drop-down list are:</p> <ul style="list-style-type: none">• Meters• Feet• Inches• Yards• Kilometers• Miles• Nautical Miles• US Survey Feet• Millimeters• Namibian Meters• Chains• Links• Centimeters <p>NOTE — This setting is for direct measures of distance only. Units for Northing and Easting distances are controlled by the Coordinate Units field on the Coordinate System form.</p>	Meters

Units form: Fields (Continued)

Field	Description	Default
Area Units	<p>The unit that areas are measured and displayed in. Options in the drop-down list are:</p> <ul style="list-style-type: none">• Square Meters• Acres• Square Feet• Hectares• Square Kilometers• Square Miles	Square Meters
Velocity Units	<p>The unit that velocities are measured and displayed in. Options in the drop-down list are:</p> <ul style="list-style-type: none">• Meters per Second• Feet per Second• Kilometers per Hour• Miles per Hour• Knots	Kilometers per Hour
Angle Units	<p>The unit that angles are measured and displayed in. Options in the drop-down list are:</p> <ul style="list-style-type: none">• Degrees• Gradians• Mils	Degrees

Units form: Fields (Continued)

Field	Description	Default
Lat/Long Format	<p>The format that latitude and longitude values are displayed in. You can enter values in a different format, but they are converted to the selected format. Options in the drop-down list are:</p> <ul style="list-style-type: none"> • DD°MM'SS.ss" • DD°MM.mmm' • DD.ddd° 	DD°MM'SS.ss"
Offset Format	<p>How offset distances are measured. The options are:</p> <ul style="list-style-type: none"> • Horizontal/Vertical The offset is defined as the two-dimensional distance and vertical distance to the feature. • Slope/Inclination The offset is defined as the three-dimensional distance to the feature and the inclination of the slope. 	Horizontal/Vertical
North Reference	This field specifies whether north references are relative to true north or magnetic north.	True
Magnetic Declination	<p>The magnetic declination, in degrees. Select Auto or enter a number in the field. The number must be between -90° and 90°.</p> <p>This field is only available if you have selected Magnetic in the North reference field.</p>	Auto

External Sensors

- Buttons
- Fields

NOTE – The External Sensors form does not appear in the **TerraSync Standard edition software**. The Standard edition software does not support external sensors.

To open the External Sensors form, in the Setup screen tap **External Sensors**. Use this form to enable and configure external sensors, such as laser rangefinders and geiger counters.

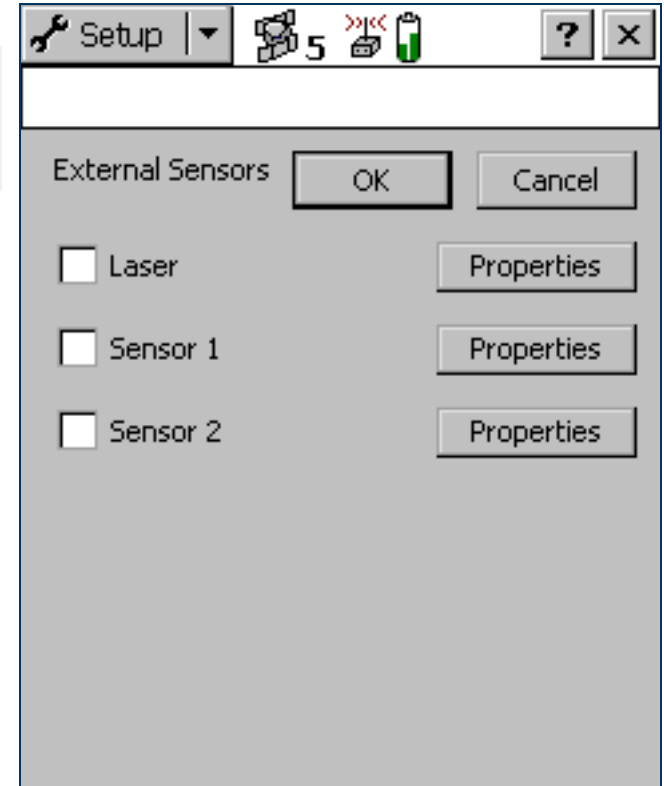

External Sensors form: Buttons

Button	Description
Properties	Opens the Sensor Properties form for the selected sensor or laser rangefinder, where you can configure communication, data, and logging properties. This button is repeated for each sensor.

External Sensors form: Fields

Field	Description	Default
Check box	Use this check box to enable or disable input from the selected sensor or laser rangefinder. When this check box is cleared, any data received from the configured sensor is ignored by TerraSync.	(cleared)
<Sensor name>	<p>The configured sensor. You cannot change the name of the Laser sensor. This is a predefined sensor for recording feature offsets.</p> <p>You can change the names of the other two sensors in the Sensor Properties form.</p> <p>TIP — To use a laser rangefinder to record attribute values instead of offsets (for example, to record the heights of trees), configure it using Sensor 1 or Sensor 2.</p>	Laser <i>or</i> Sensor #

Sensor Properties form

- **Fields**

To open the Sensor Properties form, in the **External Sensors form** tap a **Properties** button.

The image shows a screenshot of a mobile application interface. At the top, there is a status bar with a 'Setup' menu, a signal strength indicator, the number '5', a battery icon, and a close button. Below this is a dialog box titled 'Sensor Properties' with 'OK' and 'Cancel' buttons. The form contains the following fields:

- Name:** A text input field containing 'Sensor 1'.
- Communications:** A section containing several dropdown menus:
 - Port:** Set to 'None'.
 - Baud Rate:** Set to '9600'.
 - Data Bits:** Set to '8'.
 - Stop Bits:** Set to '1'.
 - Parity:** Set to 'None'.
- Data Identification:** A dropdown menu at the bottom of the form.

Sensor Properties form: Fields

Field	Description	Default
Name	The name of the sensor.	(none)
Port	The serial (COM) port that the sensor is connected to.	None
Baud Rate	<p>The baud rate the field computer and external sensor communicate at. The options are:</p> <ul style="list-style-type: none"> • 115K • 58K • 38K • 19K • 9600 • 4800 • 2400 • 1200 • 600 • 300 <p>If the selected sensor is the Laser sensor, the only options are 4800 and 9600.</p>	<p>9600 (external sensor) <i>or</i> 4800 (laser)</p>

The following fields do not appear if the Laser sensor is selected:

Data Bits	<p>The number of data bits used when the field computer and external sensor communicate. The options are:</p> <ul style="list-style-type: none"> • 7 • 8 	8
Stop Bits	<p>The number of stop bits used when the field computer and external sensor communicate. The options are:</p> <ul style="list-style-type: none"> • 1 • 2 	1

Sensor Properties form: Fields (Continued)

Field	Description	Default
Parity	<p>The parity setting used when the field computer and external sensor communicate. The options are:</p> <ul style="list-style-type: none"> • None • Odd • Even 	None
Prefix String	<p>The static sequence of characters that begins each message. The prefix is used to specify when to start recording the incoming data stream. The prefix may be up to 30 characters in length. If you do not want to specify a prefix, leave this field blank.</p> <p>For example, all NMEA-compliant sensors output messages that begin with a \$ character, followed by one or more characters identifying the specific sensor.</p> <p>NOTE — TerraSync strips off the prefix characters before it stores the message. For example, if you specify a prefix of ABC, and the message is ABC12345, only 12345 is stored.</p>	(none)
Suffix String	<p>The static sequence of characters that ends each message. The suffix is used to specify when to stop recording the incoming data stream. The suffix may be up to 30 characters in length. If you do not want to specify a suffix, leave this field blank.</p> <p>For example, all NMEA-compliant sensors output messages that are terminated with a carriage return and line feed characters.</p> <p>NOTE — TerraSync strips off the suffix characters, and any characters after the suffix, before it stores the message. For example, if you specify a suffix of XYZ, and the message is 12345XYZ17, only 12345 is stored.</p>	(none)

Sensor Properties form: Fields (Continued)

Field	Description	Default
Max Bytes	<p>Limits the length of each message to a specific number of bytes. This value includes the prefix and suffix strings, if they are defined. You cannot enter a value in this field that is less than the combined length of the prefix and suffix strings.</p> <p>If you do not want to specify a maximum number of bytes, leave this field blank. Do not enter 0.</p> <p>The maximum value for the Max Bytes field is 242. This is the maximum length for UNINTERPRETED_SENSOR_DATA SSF records.</p>	(none)
Time Out	<p>The maximum time that may elapse between receiving characters of the same message. If a character is received after the timeout period has elapsed, it is considered to be the start of a new message. The timeout value may be between 0 and 0.5 seconds.</p>	0.10s
Receive Mode	<p>How the TerraSync software receives data from the sensor. The options are:</p> <ul style="list-style-type: none"> • Unsolicited The sensor emits data continuously. Positions are logged at the configured interval for the current feature type, and whenever a sensor record is received. • Requested Data is only logged from the sensor when it is requested by TerraSync. You can configure request intervals for each feature type, or use the Trigger <sensor name> option in the Data section to request data when you need it. 	Unsolicited

Sensor Properties form: Fields (Continued)

Field	Description	Default
Request String	<p>The string that TerraSync sends to the sensor to request data. This field only appears if the Receive Mode field is set to Requested.</p> <p>TIP — You can include non-printable characters (for example, line feeds) and system commands in the request string. For more information, see Request Codes.</p>	(none)
Point Feature	<p>The interval at which data is requested or read from the sensor for point features. The options are:</p> <ul style="list-style-type: none"> • Off Data from this sensor is not recorded for point features. • 5s Data from this sensor is requested or read every five seconds. • All All data sent by the sensor is read. This option is only available if the Receive Mode field is set to Unsolicited. • Trigger Data is requested when the Trigger <sensor name> option is selected in the Data section. This option is only available if the Receive Mode field is set to Requested. <p>You can also enter an interval, in seconds, in this field.</p>	All
Line/Area Feature	<p>The interval at which data is requested or read from the sensor for line and area features. The options are as for Point Feature above.</p>	All
Not in Feature	<p>The interval at which data is requested or read from the sensor for between feature positions. The options are as for Point Feature above.</p>	All

Sensor Properties form: Fields (Continued)

Field	Description	Default
Data Destination	<p>How the sensor data should be saved in the data file. The options are:</p> <ul style="list-style-type: none">• Uninterpreted The data is stored in the data file in independent UNINTERPRETED_SENSOR_DATA records.• As attribute The data is stored in an attribute of the current feature. Use the Attribute Name field to specify which attribute to use.	Uninterpreted
Attribute Name	<p>The name of the attribute that the sensor data is to be saved in. If the feature does not contain an attribute with this name, the data is ignored.</p> <p>TIP — You can store sensor data in a text or numeric attribute. However, if you use a numeric attribute, any data that cannot be interpreted as a number or that is not in the attribute's value range will be ignored. To ensure that no data is lost, use a text attribute that is as long as the longest possible message from the sensor.</p>	(not displayed)

Request Codes

To include a non-printable character (for example, a line feed) or a system command in a sensor request string, enter a backslash (\) followed by a hexadecimal code. The following codes are supported:

Code	Value	Code	Value
\00	nul	\10	dle
\01	soh	\11	dc1
\02	stx	\12	dc2
\03	etx	\13	dc3
\04	eot	\14	dc4
\05	enq	\15	nak
\06	ack	\16	syn
\07	bel	\17	etb
\08	bs	\18	can
\09	tab	\19	em
\0a	lf	\1a	sub
\0b	vt	\1b	ec
\0c	ff	\1c	fs
\0d	cr	\1d	gs
\0e	so	\1e	rs
\0f	si	\1f	us

TIP — If you enter a single backslash, TerraSync treats the next two characters as hexadecimal. To include a backslash character, enter `\\`.

TROUBLESHOOTING

This section lists potential problems and describes how to solve them. They are grouped into the following categories:

- Communications
- Field computer
- GPS
- Real-time
- Using the TerraSync software
- Position accuracy

Communications

This section lists possible causes of, and solutions to, the following communication problems:

- ActiveSync does not connect to the CE device
- Data transfer is slow
- TerraSync does not list the COM port that you want to use
- The desktop computer does not connect to the CE device
- You cannot send or receive data files by e-mail from within TerraSync

ActiveSync does not connect to the CE device

Possible cause	Solution
The CE device is not connected securely to the cradle or data cable.	Check cabling and then try to connect again.
ActiveSync has timed out.	Lift the CE device out of the cradle and then replace it. Unplug the CE device's data cable and then plug it in again.
The TerraSync software is trying to connect to the GPS receiver using the COM port that ActiveSync is using.	Disconnect from GPS , or exit the TerraSync software.
The serial (COM) port is configured in the TerraSync software for use with a laser rangefinder.	Exit the TerraSync software. Change the selected port in the Laser port field on the Logging Settings form .
An ActiveSync partnership with another CE device is interfering with connection to the device.	In ActiveSync, delete any partnerships with other CE devices. Use a guest relationship, not a partnership.

Data transfer is slow

Possible cause	Solution
The CE device is not configured to connect at the maximum baud rate available.	Increase the connection speed. For more information, see ActiveSync .

TerraSync does not list the COM port that you want to use

Possible cause	Solution
You added the COM port after you started TerraSync. For example, you inserted a PC card adaptor into a PCMCIA or CompactFlash slot on the field computer.	TerraSync only checks which COM ports are defined when it starts up. To force the software to check for new COM ports, exit and then restart TerraSync. NOTE — On a GeoExplorer CE series handheld, the COM1 serial port is always defined, even if the serial clip is not connected to the handheld.
The port is a Bluetooth port that is no longer available.	Re-enable Bluetooth to re-configure the COM port.

The desktop computer does not connect to the CE device

Possible cause	Solution
The CE device is not set up to establish a PC connection.	Open the Communications Properties dialog on the CE device. For information on how to do this, refer to the documentation for the CE device. Select the PC Connection tab and check that the Allow connection with desktop computer when device is attached check box is selected.
Another application is using the COM port.	Exit the other application, or disconnect it from the COM port.

You cannot send or receive data files by e-mail from within TerraSync

Possible cause	Solution
TerraSync cannot connect to your ISP because it does not have your account login details.	In the settings for the e-mail service that you are using, specify the login details for connecting to your ISP.
The data files attached to e-mails are not being downloaded from the mail server.	Configure the e-mail service that you are using to download the entire message and any attachments, not just the message header.
The field computer does not support e-mail.	Use the Trimble Data Transfer utility to transfer files to or from TerraSync.

Field computer

This section lists possible causes of, and solutions to, the following field computer problems:

- The field computer does not turn on, or turns off immediately after being turned on
- The message **Not enough memory** appears
- The screen is not visible outdoors or in bright light
- A file attached to a filename field does not open or play on a desktop computer
- A TerraSync data file has been corrupted

The field computer does not turn on, or turns off immediately after being turned on

Possible cause	Solution
The field computer's batteries are dead.	Replace or recharge the field computer batteries.
	Connect to an external power source.

The message **Not enough memory** appears

Possible cause	Solution
Not enough memory on the CE device is allocated to programs, because too much is allocated for storage.	Adjust memory allocation. For more information, see Changing memory allocation .
There is not enough free memory on the field computer.	Delete unwanted files.

The screen is not visible outdoors or in bright light

Possible cause	Solution
The screen contrast is too low.	Adjust the screen contrast. For more information, see Adjusting the screen contrast .

A file attached to a filename field does not open or play on a desktop computer

Possible cause	Solution
The file has been recorded in a special file format that is used only under Windows CE or on a specific brand of CE device. For example, there are a number of ways of encoding WAV (.wav) audio files that are specific to one brand of device.	In the software that you use to record or create the file, change the settings to record files in a format that can be read on a desktop computer.

A TerraSync data file has been corrupted

Possible cause	Solution
The field computer was reset or the batteries were removed while the software was logging data.	Open the file in the TerraSync software. The software automatically repairs and rebuilds the file. NOTE — If you suspect that a file is corrupted, rebuild it <i>before</i> transferring it to the office computer or sending it by e-mail.

GPS

This section lists possible causes of, and solutions to, the following problems with GPS or a GPS receiver:

- The message **No GPS detected** appears
- The receiver has not acquired a satellite within three minutes of starting the TerraSync software
- The receiver is not able to compute a GPS position within one minute of starting the TerraSync software

The message **No GPS detected** appears

Possible cause	Solution
The cable connecting the field computer to the GPS receiver has not been connected, has been connected incorrectly, or is faulty.	Check that the cable is connected correctly. If it appears to be correct and all other equipment appears to be correct, the cable may require servicing.
The COM port on the field computer is faulty.	Check that the COM port is undamaged. If it appears to be damaged, the field computer may require servicing.
The GPS receiver's battery has not been connected correctly.	Check that the battery is correctly connected.
The GPS receiver's battery is dead.	Recharge the GPS receiver's battery. Connect to an external power source.

The receiver has not acquired a satellite within three minutes of starting the TerraSync software

Possible cause	Solution
The receiver is still looking for satellites.	Check the Satellite information screen to see how many satellites are being tracked by the receiver.
The expected satellites are being obstructed.	The obstruction may be a building, a tree, or a large vehicle. Identify the obstruction and move away from it. <i>GPS does not work indoors.</i>
The GPS receiver's external antenna (or antenna cable) has not been connected, has been connected incorrectly, or is faulty.	Check that the external antenna is connected correctly. If the receiver still fails to acquire signals from a satellite, then the antenna and/or antenna cable may require servicing.
The receiver has not been used for a very long time, and the almanac stored in the receiver is outdated.	Wait for up to 15 minutes until a new almanac has been recorded. Subsequent restarts should then be rapid.

The receiver has not acquired a satellite within three minutes of starting the TerraSync software

Possible cause	Solution
The receiver has been set to Base mode by another application.	Reset the GPS receiver. To do this, in Setup section , tap Options and select Reset GPS receiver .

The receiver is not able to compute a GPS position within one minute of starting the TerraSync software

Possible cause	Solution
There are not enough satellites available. Four SVs are required to compute a position.	Use mission planning to check that there are sufficient satellites visible at this time.
	In the GPS Settings form , check that the minimum elevation value is not too high.
	In the GPS Settings form , check that the minimum SNR value is not too high.
The current DOP value is too high.	Use mission planning to check for times when the PDOP or HDOP value will be below the configured maximum value.
	In the GPS Settings form , check that the configured maximum DOP value (PDOP or HDOP) is not too low.

Real-time

This section lists possible causes of, and solutions to, the following problems with real-time corrections or correction sources:

- Not all positions are corrected in real time
- The TerraSync software is not using your first choice real-time correction source
- The integrated beacon component (Pro XR or XRS receiver only) does not appear to work
- The integrated satellite component (Pro XRS or Power receiver only) does not appear to work
- The real-time differential correction link does not appear to work

Not all positions are corrected in real time

Possible cause	Solution
You have chosen to use uncorrected GPS if no real-time corrections are available.	In the last Choice field on the Real-time Settings form , select Wait for real-time.

The TerraSync software is not using your first choice real-time correction source

Possible cause	Solution
Your first choice correction source is not available, so your second or third choice is being used.	In the Real-time screen , check the status of your preferred correction source. Change the configuration in the Real-time Settings form if necessary, or wait until this source is available again.
The correction source you expected is not set up as your preferred source.	In the Real-time Settings form , select your preferred real-time correction source in the Choice 1 field.

The integrated beacon component (Pro XR or XRS receiver only) does not appear to work

Possible cause	Solution
You have set the real-time source incorrectly.	In the Real-time Settings form , set one of the Choice fields to Integrated Beacon. If integrated beacon is your preferred correction source, set the Choice 1 field to Integrated Beacon.
You have set the mode or frequency incorrectly.	In the Real-time Settings form , select appropriate options in the Mode and Frequency fields.

The integrated satellite component (Pro XRS or Power receiver only) does not appear to work

Possible cause	Solution
You have set the real-time source incorrectly.	In the Real-time Settings form , set one of the Choice fields to Integrated Satellite. If integrated beacon is your preferred correction source, set the Choice 1 field to Integrated Satellite.
You have not enabled the integrated satellite component of the receiver.	For information on how to enable the integrated satellite component, refer to the GPS Pathfinder Systems Receiver Manual.
You have entered the incorrect provider, satellite, and/or frequency.	In the Real-time Settings form , select appropriate options in the Service Provider, Name, and Frequency fields.
Your satellite differential subscription has expired or has not yet been activated.	In the Integrated Satellite Status screen , check the expiry date of the satellite differential subscription. For information on how to renew or acquire a subscription, refer to the GPS Pathfinder Systems Receiver Manual.

The real-time differential correction link does not appear to work

Possible cause	Solution
The telemetry link has been incorrectly installed, powered, cabled or configured.	Install the telemetry link as specified by the supplier. Consult the supplier if necessary.
You have set the station ID incorrectly.	In the Real-time Settings form , check that you have set the Station ID field correctly.
You have configured the real-time settings incorrectly.	In the Real-time Settings form , check that the settings under the External Source heading match the telemetry link and the transmitted RTCM data stream.

Using the TerraSync software

This section lists possible causes of, and solutions to, the following operational problems:

- You cannot update a feature, add new features, or open a data file
- You cannot change settings or use some menu items
- You cannot unlock a configuration file
- Automatically generated time attributes are incorrect
- File dates are incorrect
- Some or all features are missing from the Update Features screen or the Map section
- The coordinates displayed by the TerraSync software seem to be incorrect
- You cannot select some coordinate system datums, zones, or ellipsoids
- The target icon is not at the location of the feature you selected as the navigation target
- The message `The system time of this device does not match GPS time` appears

You cannot update a feature, add new features, or open a data file

Possible cause	Solution
You are using the TerraSync Standard edition software , which does not allow you to open imported files. In this edition of the software, any file that you transfer from the office computer, create from Shapefiles, or receive by e-mail is marked Not Usable.	Upgrade to the fully functional TerraSync Professional edition.
The file is already open in the background of the Map section.	Set the map background file to None. Select another file for the map background.
Position updates are not allowed.	Set the Allow Position Update field on the Logging Settings form to Yes or Confirm.

You cannot change settings or use some menu items

Possible cause	Solution
The setting or menu item is locked by the current configuration. A locked icon (🔒) appears beside locked settings and menu items.	Unlock the configuration file.

You cannot unlock a configuration file

Possible cause	Solution
You have forgotten the configuration file's password.	Use the manager's password, TrimbleTerraSync .

Automatically generated time attributes are incorrect

Possible cause	Solution
The field computer's internal clock has been set incorrectly, or the selected time zone is incorrect.	Before you open any data files, use the World Clock utility on the field computer to set the local time and time zone correctly. For more information, refer to the documentation for the field computer.

File dates are incorrect

Possible cause	Solution
The field computer's internal clock has been set incorrectly, or the selected time zone is incorrect.	Before you open any data files, use the World Clock utility on the field computer to set the local time and time zone correctly. For more information, refer to the documentation for the field computer.

Some or all features are missing from the Update Features screen or the Map section

Possible cause	Solution
There is no data file open.	Use the New File form to create a new file, or the Existing File screen to open an existing file.
There are no features in the file to display.	Open the Collect Features screen and collect some features.
The layer in the Map section that the features belong to has been turned off, or the group in the Data section that the features belong to has been hidden.	In the Map section , tap Layers and select Filtered Features, or Unfiltered Features, to display the appropriate layer. In the Update Features screen , tap Options and select Show Filtered Features, or Show Unfiltered Features, to display the appropriate group.
The background file in the Map section is turned off or has not been selected.	If the data you want to see is in a background file, use the Background File form to check that the map is set to display this file. Then tap Layers and make sure that the Background option has a check mark beside it.

Some or all features are missing from the Update Features screen or the Map section (Continued)

Possible cause	Solution
The zoom scale is incorrect.	Check that you are not zoomed in too close or out too far to see the data. If you have distant items to display, the zoom extents of the map will be at a more distant scale.
You are viewing the wrong area in the Map screen.	Use the Pan map tool or the Pan button on the Command bar to pan the display to the appropriate area.
	Use the Zoom Extents option or the Zoom Extents button on the Command bar to zoom to a scale where all features are visible.
The features have been filtered out.	Check the Status bar to see if a filter is active. If the filter icon  is visible, open the Filter By form where you can disable or change the criteria for filters.
The features have been deleted.	Deleted features are never shown in the Map section. In the Update Features screen , highlight a deleted feature (a feature with a line through it), tap Options , and select Undelete.

The coordinates displayed by the TerraSync software seem to be incorrect

Possible cause	Solution
You have selected the wrong coordinate system or zone.	In the Coordinate System form , select the correct coordinate system and zone.
You have selected the wrong coordinate units.	In the Coordinate System form , select the coordinate system, then select the correct coordinate units.
You are using the Latitude/Longitude coordinate system and have selected the wrong datum.	In the System field on the Coordinate System form , select Latitude/Longitude and specify the correct datum.

The coordinates displayed by the TerraSync software seem to be incorrect (Continued)

Possible cause	Solution
You are using the UTM coordinate system and have selected the wrong UTM zone or datum.	In the System field on the Coordinate System form , select UTM, then specify the correct zone and datum. The traditional UTM datum for the U.S.A. is NAD-27.
You have defined a custom coordinate system, datum and/or zone incorrectly in the Coordinate System Manager utility in the GPS Pathfinder Office software.	Check the definition of the coordinate system, datum and/or zone carefully.

You cannot select some coordinate system datums, zones, or ellipsoids

Possible cause	Solution
You transferred a single coordinate system to TerraSync, or a coordinate system export file that did not include all the coordinate systems you want. When you transfer coordinate systems to TerraSync, the transferred data overwrites the existing data, so you must make sure that you transfer all the coordinate systems you require.	Create a coordinate system export file that contains all the coordinate systems that you want to use, and transfer this file to TerraSync.
The required coordinate system files have been deleted from the field computer.	Transfer the files from the GPS Pathfinder Office software again.
	To restore default coordinate systems, re-install TerraSync.

The target icon is not at the location of the feature you selected as the navigation target

Possible cause	Solution
You re-recorded the GPS position of the feature, or digitized its position. The navigation target remains at the feature's old position.	Reselect the feature as the navigation target.

The message `The system time of this device does not match GPS time` appears

Possible cause	Solution
The field computer's selected time zone is incorrect.	Before you open any data files, use the World Clock utility on the field computer to set the local time zone correctly. For more information, refer to the documentation for the field computer.

Position accuracy

This section lists possible causes of, and solutions to, the following problems with positional accuracy:

- The accuracy of recorded GPS positions is not as good as you expect
- You are unable to differentially correct GPS positions (either in real time or in postprocessing)

The accuracy of recorded GPS positions is not as good as you expect

Possible cause	Solution
You did not record sufficient positions to achieve the required accuracy.	<p>In the GPS Pathfinder Office Data Dictionary Editor utility, increase the value in the Minimum Positions field to make sure that the TerraSync software records enough positions.</p> <p>Collect more positions at each point feature.</p>
The maximum DOP value was too high. If you record positions when the DOP is high, this has a detrimental effect on the accuracy of these positions.	In the GPS Settings form , lower the maximum PDOP or HDOP value to make sure that the TerraSync software only logs accurate positions.
The minimum SNR or elevation value was too low. If you let the receiver use satellites with a low SNR or elevation, this may have a detrimental effect on the accuracy of positions calculated by the receiver.	In the GPS Settings form , raise the minimum SNR and/or elevation value to make sure that the receiver uses satellites with a strong signal.

The accuracy of recorded GPS positions is not as good as you expect (Continued)

Possible cause	Solution
You are operating in an area of high multipath.	<p>Move to an area with better GPS coverage and use offsets.</p> <p>Apply velocity filtering:</p> <ul style="list-style-type: none">• Set the Velocity Filter field on the GPS Settings form to Auto to apply velocity filtering to positions as they are recorded. If the Log SuperCorrect Data option is enabled, all positions are filtered. If at least one valid real-time correction source is selected in the Real-time Settings form, and the last Choice field is set to Wait for Real-time, then only real-time positions are filtered.• If you intend to postprocess the data, set the Log Velocity Data field or the Log SuperCorrect Data field on the Logging Settings form to On. Then, when you differentially correct the data in the GPS Pathfinder Office software, use the velocity filtering option to smooth uncorrected positions.
No configured real-time source is available, so TerraSync is using uncorrected positions.	In the last Choice field on the Real-time Settings form , select Wait for Real-time, to use differentially corrected positions only.

You are unable to differentially correct GPS positions (either in real time or in postprocessing)

Possible cause	Solution
The TerraSync software used satellites that were not visible to the GPS base station.	If the Log SuperCorrect Data option was enabled when the data was collected, use the SuperCorrect feature in the Differential Correction utility to postprocess the data using only those satellites that were common to the rover and base station.
	Make sure that the minimum elevation value in the TerraSync software is set sufficiently high that the software only uses satellites which are also visible to the GPS base station.
	Try correcting the data using another base station file.
You reset the receiver and began logging data before a new almanac was collected, causing TerraSync to use satellites that were not visible to the base station.	Wait until the receiver has collected a new almanac before you log data.
	If the Log SuperCorrect Data option was enabled when the data was collected, use the SuperCorrect feature in the Differential Correction utility to postprocess the data using only those satellites that were common to the rover and base station. This option is enabled by default.

GLOSSARY

almanac	An almanac is data, transmitted by a GPS satellite, which includes orbit information on all the satellites, clock corrections, and atmospheric delay parameters. The almanac is stored on the CE device. It is used to facilitate rapid acquisition of GPS signals when you turn on the TerraSync software, or when you have lost track of satellites and are trying to regain GPS signals.
attributes	<p>Attributes are the characteristics of a feature in a Geographic Information System (GIS). For example, a road may have a name, surface type, or a number of lanes. Each of these factors are attributes of the road feature and could have a range of possible values.</p> <p>The value chosen to describe a particular feature is called the attribute value. In our example of a road feature, Main Street could be the value of the name attribute and 4 could be the value of the number of lanes attribute.</p>
base station	A base station is a GPS antenna and receiver positioned on a known location specifically to collect data for differential correction . Base data needs to be collected at the same time as you collect data on a rover unit. A base station can be a permanent station that collects base data for provision to multiple users, or a rover unit that you locate on known coordinates for the duration of the datalogging session.
baud rate	A baud is a unit used to measure the speed of electronic code transmissions, generally one bit per second. The higher the baud rate, the faster the transfer of data. However, both the input and output device must be configured to the same baud rate for data to be successfully transferred.

bearing	A bearing is the direction from one point to another, usually measured clockwise from north. In the TerraSync software, the bearing indicates the direction from your current position to the target.
broadcast server	An Internet server that manages authentication and password control for a network of VRS servers, and relays VRS corrections from the VRS server that you select to TerraSync.
C/A code	See code phase .
carrier phase	The time taken for the L1 or L2 carrier signal generated by the satellite to reach the GPS receiver. Measuring the number of carrier waves between the satellite and receiver is a very accurate method of calculating the distance between them.
CE device	A small, usually palm-size or handheld, computer that is capable of running the Microsoft Windows CE operating system. A CE device usually has a small screen, and limited memory and storage space.
centroid	The calculated center of an area feature.
CMR	(Compact Measurement Record) A real-time message format developed by Trimble for broadcasting corrections to other Trimble receivers. CMR is a more efficient alternative to RTCM , but is not supported by all non-Trimble receivers.
Coarse Acquisition code	See code phase .
code phase	(also known as Coarse Acquisition code, or C/A code) The difference between the pseudorandom number code generated by the TerraSync software and the pseudorandom number code coming in from the satellite. The code phase data is used to quickly compute the distance to a satellite and therefore calculate your position.

cross-track error
cross-track line
data dictionary

The amount and direction by which your current **heading** differs from the **cross-track line**.

The shortest direct path from the navigation start to the navigation target.

A data dictionary is a description of the objects to be collected for a particular project or job. It is used in the field to control the collection of the spatial and attribute information about these objects. The elements of a data dictionary could include point, line, and area **features**.

datum

A datum is a mathematical model of the earth's surface. World geodetic datums are typically defined by the size and shape of an **ellipsoid** and the relationship between the center of the ellipsoid and the center of the earth.

Because the earth is not a perfect ellipsoid, any single datum will provide a better model in some locations than others. Therefore, various datums have been established to suit particular regions.

For example, maps in Europe are often based on the European datum of 1950 (ED-50). Maps in the United States are often based on the North American datum of 1927 (**NAD-27**) or 1983 (**NAD-83**).

All GPS coordinates are based on the **WGS-84** datum surface.

For more information, see **Coordinate systems**.

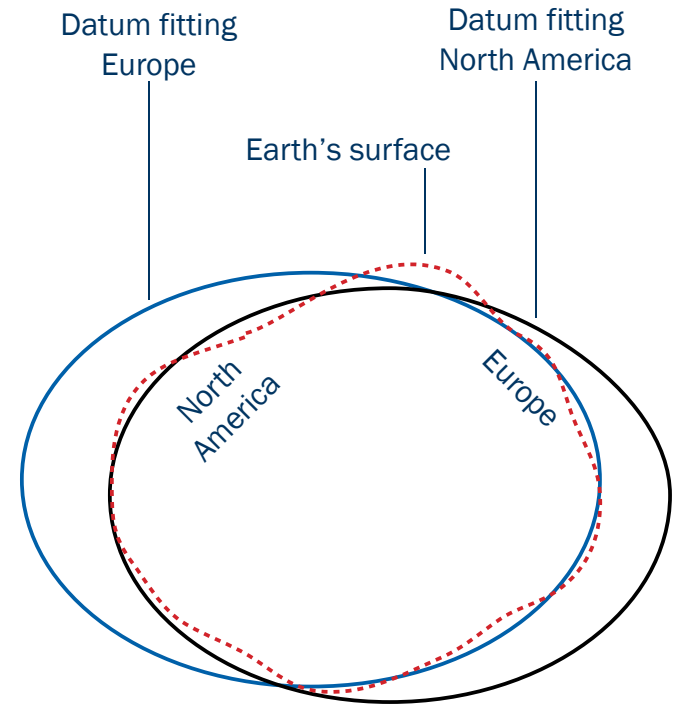

declination	See magnetic declination .
DGPS	See real-time differential GPS .
differential correction	Differential correction is the process of correcting GPS data collected on a rover with data collected simultaneously at a base station . Because it is on a known location, any errors in data collected at the base station can be measured, and the necessary corrections applied to the rover data. Differential correction can be done in real time, or after the data has been collected by postprocessing .
differential GPS	See real-time differential GPS .
digitizing	The process of creating positions manually by selecting a point on a map.
Dilution of Precision (DOP)	A measure of the quality of GPS positions, based on the geometry of the satellites used to compute the positions. When satellites are widely spaced relative to each other, the DOP value is lower, and position accuracy is greater. When satellites are close together in the sky, the DOP is higher and GPS positions may contain a greater level of error. PDOP (Position DOP) indicates the three-dimensional geometry of the satellites. Other DOP values include HDOP (Horizontal DOP) and VDOP (Vertical DOP), which indicate the accuracy of horizontal measurements (latitude and longitude) and vertical measurements respectively. PDOP is related to HDOP and VDOP as follows: $PDOP^2 = HDOP^2 + VDOP^2$
DOP	See Dilution of Precision .

EGNOS

(European Geostationary Navigation Overlay Service)

A satellite-based augmentation system that provides a free-to-air differential correction service for GPS. EGNOS is the European equivalent of **WAAS**, which is available in the United States.

ellipsoid

An ellipsoid is the three-dimensional shape that is used as the basis for mathematically modeling the earth's surface. The ellipsoid is defined by the lengths of the minor and major axes. The earth's minor axis is the polar axis and the major axis is the equatorial axis.

For more information, see **Coordinate systems**.

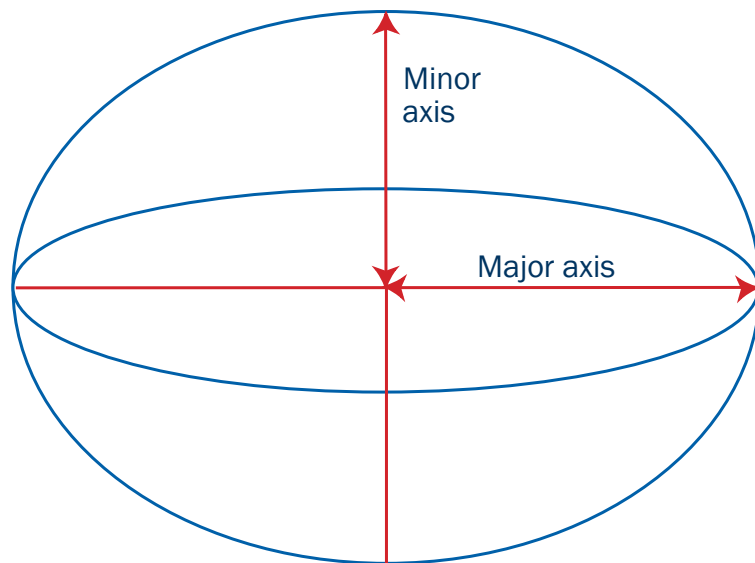

feature

A feature is a physical object or event that has a location in the real world, which you want to collect position and/or descriptive information (**attributes**) about. Features can be classified as points, lines, or areas. For example, a road sign is a point feature, a road is a line feature, and a park is an area feature.

Features are defined in a **data dictionary**.

field computer

In TerraSync documentation, a field computer is any computer that has the TerraSync software installed. The computer must either be a PC running a supported Windows desktop operating system (for example, a tablet PC, laptop, or notebook computer running Windows 2000), or be a supported **CE device**.

geoid

A geoid is a 3D surface representing **Mean Sea Level** (MSL) if it was projected to extend through the continents. Unlike an **ellipsoid** or **datum**, which have a symmetrical surface, the geoid undulates perpendicular to the force of gravity. For more information, see **Coordinate systems**.

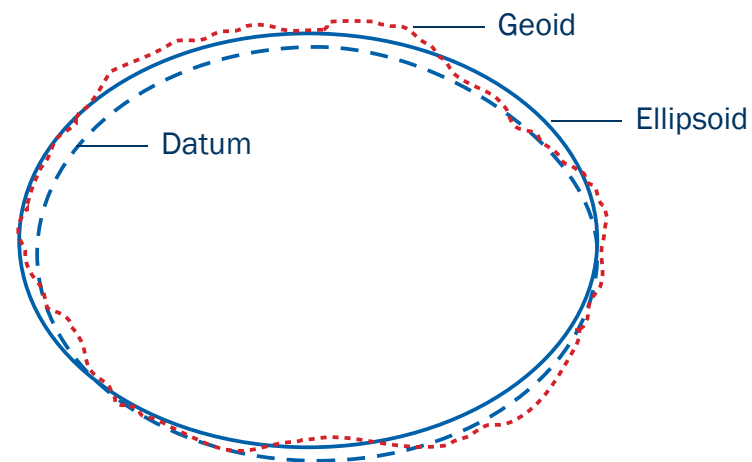

great-circle distance

The great-circle distance is the shortest distance between two points on the surface of a sphere.

guest	<p>A guest connection lets a CE device exchange and share information with a desktop computer. You need a guest connection or a partnership to transfer data between the TerraSync software on the CE device and the GPS Pathfinder Office software on the desktop computer.</p> <p>When you connect as a guest, you can:</p> <ul style="list-style-type: none"> • move or copy files between the two computers • back up files on the CE device • install or uninstall programs on the CE device <p>However, you cannot synchronize data between the two computers when you connect as a guest. To synchronize data you must set up a partnership.</p> <p>A guest connection is temporary. When the guest CE device is disconnected from the desktop computer, any settings for the guest connection are lost. The next time you connect the CE device to the desktop computer, you must set the guest connection again.</p> <p>For more information, refer to the ActiveSync Help.</p>
H/PC 2000	See Handheld PC 2000 .
HAE	See Height Above Ellipsoid .
Handheld PC 2000	<p>(H/PC 2000)</p> <p>A lightweight personal computer that is small enough to be carried. H/PC 2000 devices use either the Windows CE 3.0 or Windows CE 4.x (Windows CE .NET) operating system. These operating systems are based on the Windows operating system, but customized for computers with a limited screen size and memory.</p>
HDOP	See Horizontal Dilution of Precision .
heading	The heading is the direction you are facing or traveling, usually measured clockwise from north.

Height Above Ellipsoid (HAE)

HAE is a method for referencing altitude. Altitudes expressed in HAE are actually giving the height above the **datum**, not the **ellipsoid**. GPS uses the **WGS-84** datum and all heights are collected in relation to this surface. It is important to use the same datum when comparing altitudes in HAE.

horizon

The line at which the earth and sky seem to meet.

Horizontal Dilution of Precision (HDOP)

Dilution of Precision (DOP) is a measure of the quality of GPS positions, based on the geometry of the satellites used to compute the positions. When satellites are widely spaced relative to each other, the DOP value is lower, and position accuracy is greater. When satellites are close together in the sky, the DOP is higher and GPS positions may contain a greater level of error.

HDOP is a DOP value that indicates the accuracy of horizontal measurements. Other DOP values include VDOP (vertical DOP) and **PDOP** (Position DOP).

The TerraSync software lets you specify either a maximum HDOP value or a maximum PDOP. It uses this maximum value as an upper bound on DOP values. You can configure the desired level of accuracy, and make sure that the positions logged are of a certain quality. When the DOP exceeds this maximum, the TerraSync software stops computing GPS positions.

Using a maximum HDOP is ideal for situations where vertical precision is not particularly important, and your position yield would be decreased by the vertical component of the **PDOP** (for example, if you are collecting data under canopy).

IMS

See **Web map server**.

Internet Map Server (IMS)

See **Web map server**.

ionospheric noise	The effects that the ionosphere has on GPS signals. The ionosphere is the band of charged particles 100 to 200 kilometers (60 to 125 miles approximately) above the surface of the earth.
laser rangefinder	An instrument that uses a laser beam to accurately measure the distance to a target. Some rangefinders also measure the bearing to the target. Use a laser rangefinder to measure offsets when you are unable to record positions at the exact location of the feature.
latitude	Latitude is an angular measurement made from the center of the earth to north or south of the equator. It comprises the north/south component of the latitude/longitude coordinate system, which is used in GPS data collection. Traditionally, north is considered positive, and south is considered negative.
longitude	Longitude is an angular measurement made from the center of the earth to the east or west of the Greenwich meridian (London, England). It comprises the east/west component of the latitude/longitude coordinate system, which is used in GPS data collection. Traditionally, east is considered positive, and west is considered negative.
magnetic declination	Magnetic declination is the difference between magnetic north and true north . Declination is expressed as an angle and differs between locations.
magnetic north	A bearing that is relative to magnetic north uses the north magnetic pole as its north reference.

Mean Sea Level	(MSL) Mean Sea Level is a method of altitude reference. Altitudes expressed in relation to MSL actually give a height above the geoid . It is important to use the same geoid when comparing altitudes in MSL.
MSL	See Mean Sea Level .
multipath	Multipath occurs when GPS signals arrive at the receiver having traveled different paths. For example, this may happen if some signals are reflected off a building before reaching the receiver. If a signal takes a longer path it will show a larger distance to the satellite and therefore decrease position accuracy.
NAD-27	North American Datum of 1927. A horizontal datum employing the Clarke 1866 ellipsoid . Height values of this era are expressed in NGVD (National Geodetic Vertical Datum) of 1929.
NAD-83	North American Datum of 1983. A horizontal datum employing the GRS-80 ellipsoid . Its geometric definition is almost identical to the WGS-84 datum. For GPS purposes, the NAD-83 and WGS-84 datums are identical.
P/PC	See Pocket PC .
parity	A digital message is composed of 0's and 1's. Parity is a form of error checking that sums the 0's and 1's of the digital message. A parity error results when one of the bits is changed so that the parity calculated at message reception is not the same as it was at message transmission. Options for parity checking include even, odd, and none. Typically you should have the same parity setting on the CE device as on the external device you are communicating with.

partnership

A partnership lets a **CE device** exchange and share information with a desktop computer. You need a partnership or a **guest** connection to transfer data between the TerraSync software on the CE device and the GPS Pathfinder Office software on the desktop computer.

A partnership stores information about:

- how to connect to the device
- what types of files you can send and receive
- what files you can **synchronize**, and how to manage synchronization
- how to convert files for transfer

Unlike a guest connection, a partnership is stored on the desktop computer and remains when the CE device is disconnected from the desktop computer.

For more information, refer to the ActiveSync Help.

PC

In TerraSync documentation, a field computer that is running a supported Windows desktop operating system.

PDOP

See **Position Dilution of Precision**.

Pocket PC

(P/PC)

A lightweight personal computer that is small enough to fit in your hand or pocket. Pocket PCs use the Windows CE 3.0 operating system, which is based on the Windows operating system but is customized for computers with a limited screen size and memory.

Position Dilution of Precision

(PDOP)

Dilution of Precision (DOP) is a measure of the quality of GPS positions, based on the geometry of the satellites used to compute the positions. When satellites are widely spaced relative to each other, the DOP value is lower, and position accuracy is greater. When satellites are close together in the sky, the DOP is higher and GPS positions may contain a greater level of error.

PDOP is a DOP value that indicates the accuracy of three-dimensional measurements. Other DOP values include VDOP (vertical DOP) and **HDOP** (Horizontal DOP).

The TerraSync software lets you specify either a maximum HDOP value or a maximum PDOP. It uses this maximum value as an upper bound on DOP values. You can configure the desired level of accuracy, and make sure that the positions logged are of a certain quality. When the DOP exceeds this maximum, the TerraSync software stops computing GPS positions.

Using a maximum PDOP value is ideal for situations where both vertical and horizontal precision are important.

postprocessing

Postprocessing is the processing of satellite data after it has been collected in order to eliminate error. This involves using PC software to compare data from the rover to data collected at the base station.

Because the base station is on a known location, any errors can be determined and removed from the rover data.

PRN

See **pseudorandom number**.

pseudorandom number	<p>(PRN)</p> <p>The pseudorandom number is the code of 0's and 1's transmitted by GPS satellites, which appears to be random “noise”, but is actually a complex pattern that can be exactly reproduced.</p> <p>Each satellite has its own unique PRN code, which together are used by the GPS receiver to calculate code phase positions.</p>
raster	<p>A raster graphic is a graphical image consisting of rows and columns of dots. The color of each dot is represented by the value of one or more data bits in the image file. A bitmap (.bmp file) is a type of raster image.</p>
real-time differential GPS	<p>(also known as real-time differential correction, DGPS)</p> <p>Real-time differential GPS is the process of correcting GPS data as you collect it. This is achieved by having corrections calculated at a base station sent to the receiver via a radio link. As the rover receives the position it applies the corrections to give you a very accurate position in the field.</p> <p>Most real-time differential correction methods apply corrections to code phase positions. RTK uses carrier phase measurements.</p>
real-time kinematic rover	<p>See RTK.</p> <p>A rover is any mobile GPS datalogger collecting or updating data in the field, typically at an unknown location. Data collected on a rover can be differentially corrected relative to base station data.</p>
roving mode	<p>During RTK data collection, TerraSync logs line and area features, and between feature positions, in roving mode. Point features and vertices are logged in static mode.</p> <p>In roving mode, TerraSync records all RTK-corrected positions that meet the precision tolerances you have specified. All other positions are discarded.</p>

RTCM	<p>(Radio Technical Commission for Maritime Services)</p> <p>A commission established to define a differential data link for the real-time differential correction of roving GPS receivers. There are two types of RTCM differential correction message. However, all Trimble GPS receivers use the newer version 2 RTCM protocol.</p>
RTK	<p>(real-time kinematic)</p> <p>A real-time differential GPS method that uses carrier phase measurements for greater accuracy.</p>
signal-to-noise ratio	<p>(SNR)</p> <p>The signal strength of a satellite is a measure of the information content of the signal, relative to the signal's noise. The typical SNR of a satellite at 30° elevation is between 10.0 and 15.0. The quality of a GPS position is degraded if the SNR of one or more satellites in the constellation falls below 4.0.</p> <p>The TerraSync software lets you set a minimum SNR value. This value is used to determine whether the signal strength of a satellite is sufficient for that satellite to be used by the GPS receiver. If a satellite's SNR is below the configured minimum SNR, that satellite is not used to compute positions.</p>
site	<p>A site consists of an existing coordinate system plus an extra set of parameters for horizontal and vertical adjustments. Together these provide the best fit of GPS data to a specific area or site. Because the additional corrections are only valid for a limited area, that area is called a <i>site</i>, or <i>local site</i>.</p> <p>A coordinate system is designed to apply over a large area and does not provide for variations that occur in local coordinates. When you create a site, you shift coordinates obtained using GPS so that they better fit coordinates in the existing map grid that were obtained using traditional surveying methods.</p>

SNR	See signal-to-noise ratio .
SSF	(Standard Storage Format) A Trimble file format. SSF files store GPS data from a Trimble GPS receiver. Usually these files have the filename extension .ssf. A corrected SSF file has a .cor or .phs extension; an SSF file created by importing data has the extension .imp.
static mode	During RTK data collection, TerraSync logs point features and vertices in static mode. Line features, area features, and between feature positions are logged in roving mode . In static mode, TerraSync records only the RTK-corrected position with the best precision. All other positions are discarded.
synchronize	Synchronization is the process where ActiveSync compares information on the CE device with the corresponding information on the desktop computer, and then updates either computer with the latest information. The data stored by the TerraSync software is not synchronized by ActiveSync. Use the Trimble Data Transfer utility in the GPS Pathfinder Office software to transfer data to and from the TerraSync software. For more information, refer to the ActiveSync Help.
true north	A bearing that is relative to true north uses the north celestial pole as its north reference.
UTC	Universal Time Coordinated. UTC is a time standard based closely on local solar meantime at the Greenwich meridian (GMT). GPS time is directly related to UTC.

UTM	<p>Universal Transverse Mercator Map Projection.</p> <p>A special case of the Transverse Mercator projection. Abbreviated as UTM, it consists of 60 north/south zones, each 6 degrees wide in longitude.</p>
vector	<p>A vector graphic is a graphical image consisting of mathematical descriptions of lines, points, and areas.</p> <p>When you transfer an SSF data file to the TerraSync software as a <i>background file</i>, its attribute information is removed, leaving only the vector information. You can view the features in the map, but you cannot select them, view their attributes, or edit them.</p>
velocity	<p>Velocity is essentially a measure of speed that takes into account direction of travel as well as the distance traveled over a period of time.</p>
vertex	<p>A point on a line or area feature where two adjacent segments of the feature join. Each position that you collect for a line or area feature is a vertex of that feature.</p>
VRS	<p>(Virtual Reference Station)</p> <p>A VRS system consists of GPS hardware, software, and communication links. It uses data from a network of base stations to provide corrections to each rover that are more accurate than corrections from a single base station.</p> <p>To start using VRS corrections, the rover sends its position to the VRS server. The VRS server uses the base station data to model systematic errors (such as ionospheric noise) at the rover position. It then sends RTCM correction messages back to the rover.</p>

WAAS	<p>(Wide Area Augmentation System)</p> <p>WAAS was established by the Federal Aviation Administration (FAA) for flight and approach navigation for civil aviation. WAAS improves the accuracy and availability of the basic GPS signals over its coverage area, which includes the continental United States and outlying parts of Canada and Mexico.</p> <p>The WAAS system provides correction data for visible satellites. Corrections are computed from ground station observations and then uploaded to two geostationary satellites. This data is then broadcast on the L1 frequency, and is tracked using a channel on the GPS receiver, exactly like a GPS satellite.</p> <p>Use WAAS when other correction sources are unavailable, to obtain greater accuracy than autonomous positions. For more information on WAAS, refer to the FAA website at http://gps.faa.gov.</p> <p>The EGNOS service is the European equivalent of WAAS.</p>
waypoint	<p>A waypoint is a geographical point that, unlike a feature, holds no attribute information beyond a name and location. Typically, waypoints are used to denote objects whose locations are of primary interest, such as a survey mark. Waypoints are most often used for navigation.</p> <p>NOTE — The TerraSync software does not support waypoints explicitly. However, if you transfer a waypoint file to a CE device running the TerraSync software, it is converted during transfer into a data file which contains only Waypoint point features. You can open this file as a data file or as a background file.</p>
Web map server	<p>An Internet site that lets users download GIS data, background, and other files for a specified geographical area. TerraSync can download raster background files from a Web map server.</p>
WGS-84	<p>WGS-84 is an abbreviation for World Geodetic System 1984. WGS-84 has superseded WGS-72 as the datum used by GPS since January 1987.</p> <p>The WGS-84 datum is based on the ellipsoid of the same name.</p>

INDEX

Symbols

- .bmp files
 - managing
 - using as background files
- .cor files
- .cse files
- .imp files
- .jpg files
 - managing
 - using as background files
- .phs files
- .shp files
 - reading from
 - using as background files
 - writing to
- .sid files
 - managing
 - using as background files
- .ssf files
 - managing
 - overview

- .tcf files
 - managing
 - overview
 - troubleshooting
- .tif files
 - managing
 - using as background files
- .wav files
 - customizing
 - managing
- .wld files

Numerics

- 3D GPS position
- 5700 receiver
 - cabling diagrams
 - overview
 - power output

- 5800 receiver
 - cabling diagrams
 - overview
 - power output
- 802.11b wireless LAN, using for Internet connection to VRS server

A

- About screen
- accelerator keys
- ActiveSync. *See* Microsoft ActiveSync
- advanced logging options
- almanac
 - date
 - definition
- Altitude (Alt.) information field
- always-on Internet connection
- animated skyplot, in Plan screen

- antenna height
 - confirming
 - setting
- antenna icon
- Antenna is not connected to GPS
 - receiver message
- Antenna Settings step
- ArcIMS protocol
- area features
 - collecting
 - collecting point features as well
 - continuing
 - offsets
 - offsets, setting
- areas, measuring
- associating data dictionary with new data file
- Attempting to connect to GPS receiver message
- attribute entry form
 - for existing feature
 - for new feature
- attribute values
 - auto-generating
 - editing
 - entering
 - filling in from external sensor

- filtering by
 - filtering by (tutorial)
 - updating
- attributes
 - adding to data dictionary
 - auto-incrementing
 - auto-incrementing options
 - definition
 - deleting from data dictionary
 - editing in data dictionary
 - menu values
 - naming
 - storing filenames in
 - types
- authenticating
 - dial-up VRS connection
 - Internet VRS connection
- authorization key, using to upgrade TerraSync
- auto-generating
 - attributes
 - feature labels
- auto-incrementing attributes
 - overview
 - setting options
- automatically panning in Map screen

- averaged vertices
 - overview
 - recording

B

- background file
 - creating from Shapefiles
 - downloading from map server
 - selecting
 - transferring SSF file to TerraSync as
- Background File form
- Background map layer
- backlight
- Base file logging settings form
- base files
 - logging
 - selecting for postprocessing
- base logging icon
- base station
 - definition
 - receiver port settings
 - using TerraSync to set up

Base Station Setup wizard
 Antenna Settings step
 Logging and GPS Settings step
 overview
 Real-Time Output step
 Reference Position step
 Batch Processor utility
 battery icon
 baud rate
 communicating with ActiveSync
 definition
 for external real-time source
 connected to field computer
 for external real-time source
 connected to GPS receiver
 for external sensor
 for NMEA output
 for real-time correction output from
 base station
 for serial port connection to VRS
 server
 Beacon-on-a-Belt receiver
 configuring
 status
 troubleshooting
 Bearing information field
 bearing to go arrow

bearing to satellite
 bearing, definition
 Bearing-Bearing Offset form
 bearing-bearing offsets
 creating
 overview
 Between Feature GPS map layer
 between feature GPS positions
 displaying on map
 recording
 bitmap files
 managing
 using as background files
 blocks of data
 Bluetooth, using for Internet connection
 to VRS server
 BoB Status screen
 BoB. *See* Beacon-on-a-Belt receiver
 Br(M)
 Br(T)
 broadcast server
 definition
 overview
 selecting VRS server from
 broadcasting real-time corrections
 bull's-eye in Close-up screen
 buttons

C
 C/A code, definition
 cabling diagrams
 calibrating digital camera to UTC
 calibration photograph
 carrier phase data collection
 blocks
 configuring accuracy
 logging settings
 minimum number of satellites
 overview
 carrier phase measurements
 collecting for postprocessing
 definition
 overview
 using in RTK data collection
 carrier time
 in Receiver status screen
 in status bar
 CDMA connection to Internet
 CE device
 battery level
 changing memory allocation
 changing screen contrast
 connecting to desktop computer

#	A	B	C	D	E	F	G	H	I	J	K	L	M	N	O	P	Q	R	S	T	U	V	W	X	Y	Z
command bar										integrated beacon								coordinate system								
overview										integrated RTK radio									changing							
panning										integrated satellite									configuring							
zooming										Confirm Antenna Height form									Coordinate System Manager utility							
Comms screen										connect icon									datum transformation							
communications										connecting TerraSync to GPS receiver									datums							
problems										connecting TerraSync to VRS server									default geoid in TerraSync							
status										connection between CE device and office computer									geoid							
complex offsets										establishing									map projection							
bearing-bearing										troubleshooting									problems with							
distance-distance										connection between PC and office computer									selecting for import							
overview										Connection Manager utility									selecting when reading from Shapefiles							
triple bearing										connection speed									transferring							
triple distance										Construct Target Offset form									coordinate system export files							
configuration										context-sensitive help, accessing									creating							
changing										Continue feature form									transferring							
reloading										continuing line and area features									Coordinate System form							
configuration files										how to									Coordinate System Manager utility							
managing										overview									coordinate systems supplied with TerraSync							
overview										contrast, changing on CE device									copying files							
troubleshooting										controlling logging from the Map section									copyright							
Configuration Manager utility										coordinate geometry, for complex offsets									corrupted data files, repairing							
configuring																			Create Feature button							
Beacon-on-a-Belt receiver																										
carrier phase data collection																										
coordinate system																										
external correction source																										

creating

- features from the Map section
- manual positions
- new data file
- new data file (tutorial)
- project using GPS Pathfinder Office

criteria for filtering

cross-track error

- definition
- representing in lightbar

Cross-track information field

cross-track line

- definition
- in Map section
- navigating along

current configuration file

current GPS position

- icon in Map section
- in Navigation section

Custom mode, configuring GPS settings

in

customizing sounds

D

data

- collecting new features
- differentially correcting
- updating existing features

data collection, planning

data dictionary

- adding attributes
- adding features
- auto-generating labels
- creating
- creating from data files
- creating from Shapefiles
- definition
- deleting attributes
- deleting features
- editing
- editing attributes
- editing features
- overview
- resetting to default
- selecting (tutorial)
- transferring to TerraSync
- unique feature names

Data Dictionary Editor utility

data entry

- date fields
- filename fields
- menu fields
- overview
- text fields
- time fields

data files

- corrupted
- creating
- creating data dictionary from
- creating from Shapefiles
- creating Shapefiles from
- exporting to GIS
- opening
- receiving by e-mail
- sending by e-mail
- transferring from the field computer
- using as background files
- viewing in GPS Pathfinder Office

Data section

- attribute entry form
- clearing navigation start and target
- continuing features
- creating a new file
- e-mailing files
- filtering

#	A	B	C	D	E	F	G	H	I	J	K	L	M	N	O	P	Q	R	S	T	U	V	W	X	Y	Z
	Target field								downloading									e-mail								
	tutorial									background file from map server									receiving files by							
	using									documentation									sending files by							
disconnecting										language files									End Feature button							
	from GPS receiver									software updates									Enter Coordinates form							
	from VRS server																		Enter Password form							
Disk																			entering manual coordinates for a							
	on GeoExplorer CE series handheld																		position							
	on TSCe field device																		equipment							
display, refreshing (Map screen)																			checking before going into the field							
displaying all map layers																			required for installation on CE							
Distance (Dist.) information field																			device							
Distance-Bearing Offset form																			required for installation on different							
distance-bearing offsets, creating																			PC							
Distance-Distance Offset form																			required for installation on PC							
distance-distance offsets																			error messages							
	creating																		ESRI Shapefiles							
	overview																		reading from							
documentation, downloading																			using as background files							
DOP																			writing to							
	definition																		ETA information field							
	graph in Plan screen																		existing file							
DOP type																			opening							
	selecting for base station																		opening (tutorial)							
	selecting for rover																		Existing File screen							
																			exiting the TerraSync software							
																			Export utility							

exporting data to a GIS
 extents, zooming to
 external correction source
 configuring
 troubleshooting
 external real-time icon
 external RTK icon
 external sensor
 External Sensors form
 External Source Status screen

F

F1 button
 factory defaults
 resetting GPS receiver to
 resetting TerraSync to
 Factory Defaults configuration file
 feature types
 filtering by
 filtering by (tutorial)
 list of

features
 adding to data dictionary
 attaching files to
 attribute entry form
 auto-generating labels
 automatically panning to
 collecting (Data section)
 collecting (Map section)
 continuing
 definition
 deleting (Data section)
 deleting from data dictionary
 editing in data dictionary
 filtering
 filtering (tutorial)
 logging immediately
 logging interval
 logging later
 marking as updated
 missing
 offsets
 opening for update (Map section)
 opening for update (Navigation section)
 repeating
 segmenting
 selecting in Map screen

sorting
 troubleshooting
 undeleting
 unique names
 update status
 updating
 updating positions
 field computer
 battery level
 definition
 specifications
 troubleshooting
 See also CE device
 See also PC
 fields, moving between
 file management
 File Manager screen
 file status
 filename attributes, filling in
 filename, default
 for data file created from Shapefile
 for new data file
 files
 attaching to features
 copying to memory
 copying to storage card
 corrupted

#	A	B	C	D	E	F	G	H	I	J	K	L	M	N	O	P	Q	R	S	T	U	V	W	X	Y	Z
	creating									resetting criteria to defaults									overview							
	deleting									setting criteria (Data section)									power output							
	deleting after e-mailing									setting criteria (Map section)									supported							
	moving									setting criteria (tutorial)									TSIP output							
	naming									tutorial									geoid							
	naming converted files									flashing number below satellite icon									default							
	naming data dictionary files									flashing satellite icon									definition							
	opening									fonts, installing									overview							
	receiving by e-mail									formatting of map layers									geoid files							
	renaming									forms									georeferencing digital photographs							
	sending by e-mail									data entry									GeoXM handheld. <i>See</i> GeoExplorer CE							
	troubleshooting									moving between fields									series handheld							
	<i>See also</i> data files									overview									GeoXT handheld. <i>See</i> GeoExplorer CE							
	Filter By form									frontlight									series handheld							
	filter icon																		GIS data							
	filtered features																		converting to SSF format							
	showing or hiding																		exporting to a GIS							
	tutorial																		transferring to TerraSync							
	Filtered Features map layer																		viewing							
	filtered group, dividing features into																		global shortcuts							
	filtering																		Go East (Go E) information field							
	by attribute values																		Go North (Go N) information field							
	by deletion status																		Go Up/Go Down (Up/Down) information							
	by feature type																		field							
	by update status																		GPRS connection to Internet							
	overview																									

G

general NMEA message types
generating real-time corrections
Generic data dictionary
GeoExplorer CE series handheld
enabling output on COM1
installing to
integrated GPS receiver
NMEA output

GPS
 connecting to
 logging options
 status (tutorial)
 troubleshooting

GPS disconnected message

GPS Pathfinder Office software
 using with the TerraSync software
 version required
 viewing data files in

GPS Pathfinder Office utilities
 Batch Processor
 Connection Manager
 Coordinate System Manager
 Data Dictionary Editor
 Data Transfer
 Export

GPS Pathfinder receivers
 cabling diagrams
 power output
 supported

GPS position information field in Skyplot
 screen

GPS position, current
 automatically panning to
 in Navigation section
 updating in feature with

GPS positions
 precision settings
 recording uncorrected
 updating

GPS receiver
 battery level
 connecting to
 power output
 resetting to factory defaults
 supported
 troubleshooting

GPS settings
 displayed in Satellite information
 screen
 displayed in Skyplot
 for base station
 for rover

GPS Settings form

GPS slider
 in Setup area
 precision settings
 setting (tutorial)

GPS trail

GPS Trail map layer

GPS-centered close-up style

GPSNet VRS software

graphical screens, overview

great-circle distance, definition

GSM connection to Internet

guest connection
 definition
 for CE device

H

handheld PC 2000
 definition
 GeoExplorer CE series handheld
 specifications
 Trimble Recon handheld
 TSCe field device

HDOP
 definition
 graph in Plan screen
 setting maximum value

HDOP information field

heading
 definition
 direction of travel
 showing on Direction Dial
 using lightbar to correct

Heading (Head) information field

heading arrow		
Heading locked message		
in Navigation section		
in Status section		
Heading not available message		
Height Above Ellipsoid, definition		
height of antenna		
help		
Help button		
hiding		
between feature positions		
filtered features (Data section)		
filtered features (Map section)		
GPS trail		
map background		
map layers		
unfiltered features (Data section)		
unfiltered features (Map section)		
high-accuracy data collection		
horizon, definition		
Horizontal Dilution of Precision, definition		
	I	
	icons in map section	
	icons in status bar	
	antenna	
	base logging	
	battery	
	connect	
	digitizing	
	external RTK	
	filter	
	integrated RTK radio	
	logging	
	logging carrier	
	logging static	
	logging vertex	
	memory	
	pause	
	real-time beacon	
	real-time BoB	
	real-time external	
	real-time satellite	
	real-time VRS	
	real-time WAAS	
	RTK VRS	
	satellite	
		R
		import (.imp) file
		Import utility
		Imported file status
		Imported update status
		IMS. <i>See</i> Web map server
		Inbox, on CE device
		incrementing attribute values
		information fields
		Altitude
		Bearing
		Cross-track
		Distance
		ETA
		Go East
		Go North
		Go Up/Go Down
		GPS position
		HDOP (Satellite Information screen)
		HDOP (Skyplot screen)
		Heading
		in Navigation section
		in Satellite information screen
		in Skyplot screen
		PDOP (Satellite Information screen)
		PDOP (Skyplot screen)
		Time to Go
		TTG

- Turn
- Up/Down
- Velocity
- X-Tk
- infrared, using for Internet connection to VRS server
- installing TerraSync
 - equipment required
 - installing fonts
 - on a CE device
 - on a different PC
 - on a PC
 - registering
- integrated beacon
 - configuring
 - status
 - troubleshooting
- Integrated Beacon Status screen
- integrated GPS receiver, on GeoExplorer
 - CE series handheld
- integrated RTK icon
- integrated RTK radio
 - configuring
 - status
 - using to receive RTK corrections
- Integrated RTK Radio Status screen

- integrated satellite
 - configuring
 - status
 - troubleshooting
- Integrated Satellite Status screen
- integrated WAAS
 - configuring
 - status
 - troubleshooting
- Integrated WAAS Status screen
- internal flash memory in Trimble Recon handheld
- internal RTK radio in 5700 or 5800 receiver
- internal storage card in TSCe field device
- Internet
 - always-on connection
 - connection to VRS server
 - downloading background files from
- Internet Map Server. *See* Web map server
- introduction to the TerraSync software
- ionospheric noise, definition

J

- Japanese font
- JPEG files
 - managing
 - using as background files
- Juniper Systems Allegro, installing onto

K

- keyboard
 - on Recon
 - on TSCe
 - on-screen
 - Trimble numeric
- keyboard accelerators
- keyboard shortcuts
- Korean font

L

L1 SNR
 L2 SNR
 labels
 auto-generating in data dictionary
 in Data section
 in forms
 in Map section
 LAN, using for Internet connection to VRS server
 landscape orientation
 LandStar ID
 language files
 downloading
 installing on CE device
 installing on PC
 laptop computer. *See* PC
 large screen, appearance on
 laser rangefinder
 definition
 using to record offsets
 latitude
 definition
 entering for manual position
 Layer Formatting form

Layers menu button
 layers. *See* map layers
 lightbar
 Center mode
 Chase mode
 in Map section
 in Navigation section
 line features
 collecting
 collecting point features as well
 continuing
 offsets
 offsets, setting
 segmenting
 line thickness, in Map section
 list buttons
 lists
 overview
 sorting
 sorting (overview)
 loading configuration
 local shortcuts
 locked icon
 locking configurations
 locking device screen
 Log button, in Map section

Log Later
 overview
 using to record only averaged vertices
 Log Now
 logging
 advanced options
 base data to file
 immediately
 later
 pausing and resuming (Data section)
 pausing and resuming (Map section)
 pausing and resuming (tutorial)
 uncorrected GPS positions
 Logging and GPS Settings step
 logging carrier icon
 logging carrier phase data
 overview
 settings (Data section)
 settings (Setup section)
 logging code phase data
 settings (Data section)
 settings (Setup section)
 logging icon
 behavior in static mode
 overview

Logging interval form	map display, refreshing	scale
logging intervals	map layers	selecting features
for base data	colors	selecting map points
resetting to defaults	displaying all	setting and clearing navigation start
setting (Data Dictionary Editor)	formatting	setting and clearing navigation
setting (Data section)	showing or hiding	target
setting (Setup section)	map points	zooming
setting default for data dictionary	appearance	Map section
Logging Settings form	automatically panning to	controlling logging from
logging static icon	measuring between	creating features from
logging vertex icon	selecting	options
longitude	map projection	overview
definition	Map screen	panning
entering for manual position	background file	updating features from
	command bar	map server
	current position	definition
	filtering	downloading background files from
	icons	map tools
	lightbar	Digitize
magnetic declination	map layers	Measure
definition	map tools	overview
setting	measurement information	Pan
magnetic north, definition	missing features	Select
main memory, of GeoExplorer CE series	navigating in	Zoom In
handheld	north arrow	Zoom Out
managing files	reference position	Map Tools list button
manual positions, creating		

Map window (in GPS Pathfinder Office)	message line	Microsoft ActiveSync
displaying attributes in	Navigation section	connection speed
viewing data in	Plan screen	guest connection
marking features as updated	Satellite information screen	installing
overview	Skyplot screen	overview
tutorial	message types for NMEA output	partnership
maximum HDOP, setting	messages	required version
maximum PDOP	Antenna is not connected to GPS	synchronizing data
setting in Custom mode	receiver	troubleshooting
setting in Slider mode	Attempting to connect to GPS	mini Section button
Mean Sea Level	receiver	minimum elevation
definition	GPS disconnected	in Skyplot screen
geoids	Heading locked (Navigation section)	setting with GPS slider
Measure tool in Map section	Heading locked (Status section)	minimum SNR
measured point	Heading not available	minimum specifications
measurement information	in tooltips	missing features
measuring	No GPS	mission planning
MediaMapper	Old navigation	modem, using to connect to e-mail
memory allocation, changing on CE	Old position	service
device	Poor satellite geometry	moving files
memory icon	pop-up	MrSID files
menu attributes, adding to data	Set your navigation target in the	managing
dictionary	Map or Data section	using as background files
menu buttons	Start moving	MSL, definition
menu fields		multipath, definition

N

NAD-27, definition

NAD-83, definition

Nav Start field in Direction Dial

navigating

in the Map section (tutorial)

in the Navigation section

in the Navigation section (tutorial)

navigation bearing to go arrow

navigation lightbar

in Map section

in Navigation section

Navigation options form

navigation path

navigation proximity alarm

Navigation section

Close-up screen

Direction Dial screen

information fields

message line

Nav Start field

option list

overview

resetting options to defaults

Target field

navigation start

clearing (Data section)

clearing (Map section)

icon

setting (Data section)

setting (Map section)

navigation target

clearing (Data section)

clearing (Map section)

icon

problems with

setting (Data section)

setting (Map section)

setting (tutorial)

nesting

network, using to connect to e-mail service

New Attribute form

New Attribute Type form

New Attribute Value form

new data file

creating

creating (tutorial)

default filename

default filename when reading from

Shapefiles

selecting data dictionary (tutorial)

New dictionary form

New Feature form

New File screen

New update status

NMEA messages

outputting

outputting from GeoExplorer CE

series handheld

NMEA Output Settings form

No GPS message

north arrow, in map

Not Transferred file status

notebook computer. *See* PC

not-in-feature positions. *See* between feature GPS positions

number of satellites for carrier phase data

numeric attributes, adding to data dictionary

numeric keyboard

O

- obstructions blocking satellite signals
- office computer
 - connecting to CE device
 - connecting to PC running TerraSync
- Offset form
- offsets
 - adding to features
 - bearing-bearing
 - complex
 - distance-bearing
 - distance-distance
 - for line and area features
 - overview
 - recording with laser rangefinder
 - triple bearing
 - triple distance
- Old navigation message
- Old position
- OmniSTAR ID
- online help, accessing
- online registration
- on-screen keyboards
- Open GIS protocol

- opening existing file
 - overview
 - tutorial
- operating systems supported
- option lists
 - Map section
 - Navigation section
- options for logging GPS data
- Options menu buttons
- orbit trails, displaying in Plan section
- other software required
- output
 - NMEA messages
 - real-time differential correction messages

P

- P/PC, definition
- Pan tool in Map section
- panes
- panning
- parity, definition

- partnership
 - definition
 - setting up
- password
 - for configuration files
 - troubleshooting
- Pause button
 - Data section
 - Map section
- pause icon
- pausing logging
 - in the Data section
 - in the Map section
 - overview
 - to ensure only vertices are recorded
 - tutorial
- PC
 - battery level
 - connecting to desktop computer
 - definition
 - installing TerraSync on
 - installing TerraSync on different PC
 - specifications
 - troubleshooting

<p>PDOP</p> <ul style="list-style-type: none"> definition graph in Plan screen setting maximum value <p>PDOP information field</p> <ul style="list-style-type: none"> in Satellite Information screen in Skyplot screen <p>Plan screen</p> <ul style="list-style-type: none"> animated skyplot DOP graph message line overview <p>planning a data collection session</p> <p>planning skyplot</p> <p>Pocket PC</p> <ul style="list-style-type: none"> definition specifications <p>Pocket receiver</p> <p>point features</p> <ul style="list-style-type: none"> bearing-bearing offsets collecting while recording line or area features distance-bearing offsets distance-distance offsets offsets triple bearing offsets triple distance offsets 	<p>Point offset type form</p> <p>point symbol</p> <p>Poor satellite geometry</p> <p>pop-up messages</p> <p>portrait orientation</p> <p>Position Dilution of Precision, definition</p> <p>position information tooltip</p> <p>positions</p> <ul style="list-style-type: none"> accuracy digitized logging later manual updating <p>postprocessable carrier phase data</p> <p>postprocessing</p> <ul style="list-style-type: none"> definition overview <p>power output from GPS receiver</p> <p>Power receiver</p> <p>precision estimates</p> <ul style="list-style-type: none"> in satellite icon overview setting minimum <p>precision level for GPS</p> <ul style="list-style-type: none"> Setup section tutorial <p>predicting satellite geometry</p>	<p>preparing</p> <ul style="list-style-type: none"> for data collection for data update <p>primary pane</p> <p>PRN, definition</p> <p>Pro XL receiver</p> <p>Pro XR receiver</p> <p>Pro XRS receiver</p> <p>problems</p> <ul style="list-style-type: none"> using the TerraSync software with CE device with communications with GPS with position accuracy with real-time corrections <p>program memory, changing allocation on CE device</p> <p>project, creating using GPS Pathfinder Office</p> <p>proof-of-purchase number</p> <p>proximity alarm</p> <p>pseudorandom number</p> <ul style="list-style-type: none"> definition of satellite
---	--	---

Q

QA/QC data, logging
questions

R

radio, troubleshooting
RAM
raster graphics
 as background files
 definition
raw mode, of VRS server
Read dictionary from data form
Read from Shape form
reading from Shapefiles
real-time age limit
real-time differential correction
 definition
 settings
 sources
 status
 troubleshooting

real-time differential correction sources
 Beacon-on-a-Belt receiver
 external source
 integrated beacon receiver
 integrated RTK radio
 integrated satellite receiver
 integrated WAAS/EGNOS receiver
real-time icons
 beacon
 BoB
 external
 external RTK
 integrated RTK radio
 RTK VRS
 satellite
 VRS
 WAAS
real-time kinematic data collection. *See*
 RTK data collection
Real-Time Output step
real-time satellite icon
Real-time Settings form
Real-time Summary screen
real-time WAAS icon
Receive via E-mail form

receiver
 power output
 resetting to factory defaults
 setup
 troubleshooting
Receiver Port Settings form
Receiver screen
receiving files by e-mail
recording area/line/point features
 together
recording between feature positions
reference position
 icon in Map section
 specifying
Reference Position step
refreshing map display
registering TerraSync
release notice
reloading a configuration file
renaming files
repairing corrupted files
repeating features
resetting to factory defaults
 GPS receiver
 TerraSync

Resume button
 Data section
 Map section

resuming logging
 from the Data section
 from the Map section
 tutorial

rotating skyplot
 in Plan screen
 in Skyplot screen

rover, definition

roving mode
 definition
 logging positions in
 minimum precisions for positions
 overview

RTCM age limit

RTCM, definition

RTK base station
 overview
 setting up
 using corrections from

RTK data collection
 configuring TerraSync
 definition
 minimum precision for positions
 overview

RTK icon
 RTK precision estimates, in satellite icon
 RTK VRS real-time icon

S

SAPOS FKP format for VRS messages

satellite
 bearing to
 current elevation
 L1 SNR
 L2 SNR

satellite constellation, predicting

satellite differential service
 activating subscription
 activation code
 troubleshooting

satellite icon
 carrier time
 flashing
 number below flashing
 overview
 using to check the GPS status

Satellite information screen
 information fields
 message line
 overview
 use indicator

satellite signals
 losing
 obstructions blocking

satellites
 geometry
 minimum number for carrier phase
 data
 positions not being computed

scale, in Map section

screen contrast

screens, overview

Seaview Authority tutorial

Seaview data dictionary

secondary pane

Section list button

sections
 structure
 switching between
 switching location multi-pane view

segmenting line features

Select Server form

Select tool in Map section

Slider mode, configuring GPS settings in
SNR

- definition
- graph
- setting minimum value
- viewing
- viewing values

software structure

sorting

- features
- features by filter status
- list of VRS servers
- lists

sound

- customizing
- disabling
- overview

sources of real-time corrections

specifications for field computers

spikes, reducing effect of

SSF file format, definition

SSF files

- .imp extension
- converting from GIS data format
- converting into GIS data format
- managing

Starfish Bay tutorial

start

- clearing (Map section)
- setting (Map section)

Start moving message

starting TerraSync

static mode

- behavior of animated logging icon in
- definition
- logging RTK data in
- minimum precisions for positions in

status

- Beacon-on-a-Belt
- communications
- external real-time source
- filtering by
- integrated beacon
- integrated EGNOS
- integrated RTK
- integrated satellite
- integrated WAAS
- of communication ports
- of files
- real-time
- TerraSync software

status bar

- antenna icon
- base logging icon
- battery icon
- connect icon
- digitizing icon
- external real-time icon
- external RTK icon
- filter icon
- icons
- integrated RTK icon
- logging carrier icon
- logging icon
- logging static icon
- logging vertex icon
- memory icon
- overview
- pause icon
- real-time beacon icon
- real-time BoB icon
- real-time satellite icon
- real-time VRS icon
- real-time WAAS icon
- RTK VRS icon
- satellite icon
- tooltips

Status Mode list button
 Status section
 about the TerraSync software
 BoB real-time status
 external real-time status
 integrated beacon real-time status
 integrated RTK radio real-time status
 integrated satellite real-time status
 integrated WAAS real-time status
 message line
 mission planning
 overview
 real-time status
 real-time status summary
 satellite information
 skyplot
 storage card
 copying files from
 copying files to
 in Trimble Recon handheld
 in TSCe field device
 moving files from
 moving files to
 selecting background files from

storage memory on CE device, changing allocation
 structure
 of Data section
 of Map section
 of Navigation section
 of Setup section
 of Status section
 Subsection list button
 subsections
 SuperCorrect records, logging
 supported
 CE devices
 GPS receivers
 operating systems
 PCs
 survey NMEA message types
 symbols, for point features
 synchronization
 definition
 overview
 using to receive files by e-mail
 using to send files by e-mail
 with UTC time
 system report
 system time, incorrect

T
 tablet PC. *See* PC
 target
 clearing (Data section)
 clearing (Map section)
 navigating to
 opening for update
 problems with
 setting (Data section)
 setting (Map section)
 setting (tutorial)
 Target field
 in Close-up screen
 in Direction Dial
 target icon
 in Close-up screen
 in Map section
 target-centered close-up style
 task-switching on CE device
 TDS Ranger, installing onto
 TerraSync online Help
 TerraSync Operation Guide

TerraSync software	three-dimensional GPS position	Transferred file status
accessing online help	TIFF files	transferring files
color	managing	coordinate system export file
data entry	using as background files	coordinate system files
display	time	from the field computer
exiting	calibrating digital camera	to the field computer
installing translations on CE device	incorrect	troubleshooting
installing translations on PC	time attributes, incorrect values in	transient messages
overview	time fields	translations
Professional edition	Time to Go (TTG) information field	downloading
registering	tools in Map section	installing on CE device
resetting to factory defaults	Digitize	installing on PC
screens and controls	Measure	Trimble Data Transfer utility
section overview	overview	Trimble GPS Pathfinder font
sound	Pan	Trimble numeric keyboard
Standard edition	Select	Trimble Recon handheld
starting	Zoom In	installing onto
status	Zoom Out	overview
troubleshooting	tooltips	storage card
upgrading	in Skyplot	using the keyboard
using	in status bar	Trimble VRS format
TerraSync Tutorial project	measurement information	TRIMMARK radio
creating	position information	broadcasting corrections with
opening	transient messages	receiving corrections with
TerraSync Updater utility	track line from navigation start to target	TRIMTALK radio
text attributes, adding to data dictionary	trademarks	broadcasting corrections with
text fields	trajectories, displaying in Plan section	receiving corrections with

Triple Bearing Offset form
 triple bearing offsets
 creating
 overview
 Triple Distance Offset form
 triple distance offsets
 creating
 overview
 troubleshooting
 communications problems
 configuration files
 field computer problems
 GPS problems
 position accuracy
 real-time corrections
 TerraSync software
 true north, definition
 TSCe field device
 installing onto
 overview
 storage card
 using the keyboard
 TSIP messages, outputting from
 GeoExplorer CE series handheld
 TTG information field
 Turn information field

tutorial
 data collection
 data update
 preparing for data collection
 preparing for data update
 processing the data
 scenario
 type of DOP
 for base station
 for rover

U

unable to update features
 unattended base station
 uncorrected GPS positions, recording
 undeleting features
 underlined letters in menus
 Undo button
 Unfiltered Features map layer
 unfiltered features, showing or hiding in
 Data section
 unfiltered group, dividing features into
 uninterpreted sensor data
 unique names for features

Units form
 units of measurement, specifying
 unlocking configurations
 Up/Down information field
 Update Features screen
 missing features
 overview
 update status
 update status
 filtering by
 filtering by (tutorial)
 Imported
 marking feature as updated
 marking feature as updated
 (tutorial)
 New
 overview
 Updated
 Updated update status
 Updater utility
 updating
 attributes
 attributes from the Map section
 existing data
 GPS positions
 TerraSync software

upgrading from previous version of TerraSync

URL

of VRS server
of Web map server

use indicator, in Satellite information screen

using TerraSync

overview
problems with

USNG coordinate system

entering coordinates in
using

UTC

definition
displaying
synchronizing with

UTC Time screen

utilities

Batch Processor
Connection Manager
Coordinate System Manager
Data Transfer
Export

UTM, definition

V

values, entering for attributes

vector graphics

as background files
definition

velocity filtering

Velocity information field

velocity, definition

vertex

definition
overview
recording

Vertex form

vertex icon

viewing

attributes in GPS Pathfinder Office
data files in GPS Pathfinder Office
features on the map
GIS data
GPS status

virtual keyboards

VRS (virtual reference station)

overview
server software
supported receivers

VRS real-time icon

VRS server

accessing through broadcast server
connecting to
direct dial connection
disconnecting from
formats
Internet connection
selecting
serial port connection
using corrections from
using RTK corrections from

W

WAAS

definition
icon in skyplot
See also integrated WAAS

warning messages

Web map server

definition
downloading background files from
WGS-84, definition

Windows CE

- adjusting screen contrast
- changing memory allocation
- supported operating systems
- switching between applications
- troubleshooting
- using

Windows, supported operating systems

wireless LAN, using for Internet

- connection to VRS server

wireless modem, using for Internet

- connection to VRS server

World files

Write to Shape form

writing to Shapefiles

Z

zone, changing

zoom extents

Zoom In tool in Map section

Zoom Out tool in Map section

zooming in Map screen

LEGAL INFORMATION

Copyright

© 2000–2003 Trimble Navigation Limited. All rights reserved.

For STL support, the TerraSync software uses the Moscow Center for SPARC Technology adaptation of the SGI Standard Template Library. Copyright © 1994 Hewlett-Packard Company, Copyright © 1996, 97 Silicon Graphics Computer Systems, Inc., Copyright © 1997 Moscow Center for SPARC Technology.

Portions of this computer program are copyright © 1995–1999 LizardTech, Inc. All rights reserved. MrSID is protected by U.S. Patent No. 5,710,835. Foreign Patents Pending.

Release Notice

This is the September 2003 release (Revision A) of the TerraSync Operation Guide. It applies to version 2.40 of the TerraSync software.

Trademarks

Trimble, the Sextant logo with Trimble, GeoExplorer, and GPS Pathfinder are trademarks of Trimble Navigation Limited, registered in the United States Patent and Trademark Office. The Globe & Triangle logo, BoB, GeoXM, GeoXT, GPSNet, TerraSync, TRIMMARK, TRIMTALK, TSCe, and VRS are trademarks of Trimble Navigation Limited. Recon is a trademark of Tripod Data Systems Inc., a wholly-owned subsidiary of Trimble Navigation Limited.

Windows is a registered trademark of Microsoft Corporation.

MediaMapper is a trademark of Red Hen Systems, Inc. and is used under license.

All other trademarks are the property of their respective owners.